

SIMATIC

FM 353 Stepper Drive Positioning Module

Manual

Preface, Contents	
Product Overview	1
Basic Principles of Positioning	2
Installing and Removing	3
Wiring	4
Defining Parameters	5
Programming the Technological Functions	6
Starting up	7
Human-machine Interface	8
Description of Functions	9
Writing Traversing Programs	10
Troubleshooting	11
Appendices	
Technical Specifications	A
User Data Block (AW-DB)	B
List of Abbreviations	C
Index	

Safety Information

This Manual contains information which you should carefully observe to ensure your own personal safety and the prevention of damage to the system. This information is highlighted by a warning triangle and presented in one of the following ways depending on the degree of risk involved:



Danger

indicates that death or severe personal injury damage **will** result if proper precautions are not taken.



Warning

indicates that death or severe personal injury damage **can** result if proper precautions are not taken.



Caution

indicates that minor personal injury can result if proper precautions are not taken.

Caution

without warning sign means that material damage can occur if the appropriate precautions are not taken.

Attention

means that an undesired result or a condition may occur if the appropriate note is not observed.

If more than one level of hazard can occur, the warning note of the correspondingly highest level is used in all cases. If a warning note with a warning triangle warns of personal injury, an additional warning of material damage can be included in the same warning note.

Qualified personnel

The unit may only be started up and operated by **qualified personnel**. Qualified personnel as referred to in the safety guidelines in this document are those who are authorized to start up, earth and label units, systems and circuits in accordance with relevant safety standards.

Proper use

Please note the following:



Warning

The unit may be used only for the applications described in the catalog or the technical description, and only in combination with the equipment, components and devices of other manufacturers as far as this is recommended or permitted by Siemens.

It is assumed that this product be transported, stored and installed as intended and maintained and operated with care to ensure that the product functions correctly and safely.

Trademarks

All names marked with the copyright notice ® are registered trademarks of SIEMENS AG. Other names in this publication might be trademarks whose use by a third party for his own purposes may violate the rights of the registered holder.

Copyright Siemens AG. 1996-2008 All rights reserved

The reproduction, transmission or use of this document or its contents is not permitted without express written authority. Offenders will be liable for damages. All rights, including rights created by patent grant or registration of a utility model, are reserved.

Siemens AG
Automation & Drives
90437 Nürnberg
Federal Republic of Germany

Exclusion of liability

We have checked that the contents of this publication agree with the hardware and software described herein. Nonetheless, differences might exist and therefore we cannot guarantee that they are completely identical. The information given in this publication is reviewed at regular intervals and any corrections that might be necessary are made in the subsequent printings.

© Siemens AG 1996-2008
Subject to change without prior notice.

Preface

Information

This manual contains all information about the FM 353 module:

- Hardware and functions
- Parameterization
- Human-machine interface
- S7 blocks
- Safe design

Information blocks in this manual

The following information blocks describe the purpose and application of this manual:

- Product overview of the module (Chapter 1)
This section explains the purpose and possible applications of the module. It provides introductory information about the FM 353 and its functions.
- Basic principles of positioning (Chapter 2)
Here you will find introductory information on positioning methods and associated definitions of terms.
- Installing and removing the FM 353 (Chapter 3)
Explains the installation and removal of the FM 353.
- Wiring the FM 353 (Chapter 4)
Describes the connection and wiring of drives and digital input/output modules.
- Defining parameters of the FM 353 (Chapter 5)
Describes the parameterization and functions of “Parameterize FM 357.”
- Programming the FM 353 (Chapter 6)
Describes how to program the FM 357 with STEP 7.
- Starting up the FM 353 (Chapter 7)
Describes startup procedures for the FM 353.
- Human-machine interface (Chapter 8)
Describes the various options for operating and monitoring the FM 353, and which data and signals can be used and monitored.

- Reference information and appendices for finding factual information (module functions, programming guide, interface signals, error handling, technical specifications, standard HMI user interface)
- List of abbreviations and index for looking up information.

User requirements

The present manual describes the hardware and functions of the FM 353

To set up, program and start up a SIMATIC S7-300 with the FM 353, you will need a knowledge of:

- The SIMATIC S7
Installation manual *S7-400/M7-400 Programmable Controller, Hardware and Installation*
- Your programming device (PG)
- How to perform programming with STEP 7
- How to configure an operator panel interface.

FM 353 users

The structure and presentation of the information in the manual are oriented to the intended uses of the FM 353, and the user's own activity.

It distinguishes among the following:

- Installation and wiring
These activities include installation and wiring of the FM 353.
- Parameterizing and Programming
These activities include parameterizing and programming the FM 353.
- Troubleshooting and diagnostics
These activities include detecting and correcting faults and errors
 - in the hardware setup of the module and its components
 - and in the programming, handling and control of module functions.
- Operation
These users operate the FM 353. The operator accordingly deals only with the control of positioning tasks.

Note

The PROFINET functionality described in the present manual (in the current version) is only available on request. Please get in touch with your Siemens contact partner.

Standards and approvals

Our products are in compliance with the EU Guideline 89/336/EEC “Electromagnetic Compatibility” and the harmonized European standards (EN) which it embodies.

The current version of the EC Declaration of Conformity can be found on the Internet at

<http://support.automation.siemens.com/WW/view/de/15257461>

Recycling and disposal

For recycling in an environmentally compatible manner and for the disposal of your old SIMATIC in line with present state of technology, please contact your appropriate Siemens contact partner:

<http://www.automation.siemens.com/partner>

Technical support

If you have any technical question, please do not hesitate to contact our hotline:

Time zone:	Europe/Africa	Asia/Australia	America
Telephone	+49 (0) 180 5050 222	+86 1064 719 990	+1 423 262 2522
Fax	+49 (0) 180 5050 223	+86 1064 747 474	+1 423 262 2289
Internet	http://www.siemens.com/automation/support-request		
E-mail	adsupport@siemens.com		

Note

The country-specific telephone numbers for technical consultation can be found on the Internet at: <http://www.siemens.com/automation/service&support>

Questions regarding this Manual

If you have any questions regarding this Documentation (suggestions, corrections), please send a fax or an e-mail to the following address:

Fax: +49 (0) 9131 98 63 315

E-mail: docu.motioncontrol@siemens.com

Siemens Internet address

For currently updated information on the SIMATIC products, visit us on the Internet at: <http://www.siemens.de/simatic>.

Further support

We are offering courses to help you familiarize yourself with the operation of the SIMATIC S7 programmable controller system.

Please contact your regional or the central training center in D-90027 Nürnberg, Germany under tel. +49 911-89 53 202.



Table of Contents

1	Product Overview	1-1
1.1	The FM 353 in the S7-300 programmable controller	1-2
1.2	Module description	1-7
1.3	Overview of module functions	1-9
2	Basic Principles of Positioning	2-1
3	Installing and Removing	3-1
3.1	Installing the FM 353	3-3
3.2	Removing the FM 353	3-4
3.3	Replacing modules	3-5
4	Wiring	4-1
4.1	Wiring an FM 353	4-2
4.2	Description of the drive interface	4-4
4.3	Connecting the drive unit	4-11
4.4	Description of the I/O interface	4-12
4.5	Wiring up the front connector	4-18
5	Defining Parameters	5-1
5.1	Installing "Parameterize FM 353"	5-3
5.2	Getting started with "Parameterize FM 353"	5-4
5.3	Parameter data	5-7
5.3.1	Machine data	5-9
5.3.2	Increments	5-20
5.3.3	Tool offset data	5-21
5.3.4	Traversing programs	5-23
5.4	Parameterization with "Parameterize FM 353"	5-25
5.5	Storing the parameter data in SDB $\geq 1\ 000$	5-26
6	Programming the Technological Functions	6-1
6.1	Programming fundamentals	6-4
6.1.1	Communication between the CPU and the FM 353	6-4
6.1.2	Structure of a user program	6-5
6.1.3	Distributed configuration, OB 86	6-6
6.1.4	Embedding an OP	6-6
6.1.5	Procedure for writing the user program (AWP)	6-7
6.2	Putting the FM 353 into operation with the parameter initialization tool ..	6-8

6.3	Standard function blocks of the “FMSTSV_L” block library	6-8
6.3.1	Overview of the “FMSTSV_L” function block library	6-9
6.3.2	The POS_INIT (FC 0) block – Initialization	6-10
6.3.3	The POS_CTRL (FC 1) block – Data exchange	6-12
6.3.4	The POS_DIAG (FC 2) block – Read diagnostic interrupt data	6-22
6.3.5	The POS_MSRL (FC 3) block – Read measured values	6-25
6.3.6	Interface, user data blocks (AW-DBs)	6-26
6.4	Standard function blocks of the “FM353_354” block library (also for PROFINET, upon request)	6-28
6.4.1	Overview of the “FM353_354” block library	6-28
6.4.2	The POS_INIT (FC 0) block – Initialization	6-30
6.4.3	The POS_CTRL (FC 1) block – Data exchange	6-30
6.4.4	The POS_DIAG (FC 2) block – Read diagnostic interrupt data	6-41
6.4.5	The POS_MSRL (FC 3) block – Read measured values	6-41
6.4.6	Interface, user DBs (AW-DBs)	6-42
6.5	Interrupts	6-44
6.6	User data block (AW-DB)	6-46
6.7	Sample applications	6-57
6.8	Error list, system messages (CPU)	6-64
6.9	Technical specifications	6-66
7	Starting up	7-1
7.1	Installation and wiring	7-2
7.2	Initial values for testing and optimization	7-3
7.3	Testing and optimization	7-7
7.3.1	Activating the machine data	7-13
7.3.2	Evaluating the characteristics of the stepper motor	7-14
7.3.3	Basic startup of stepper motor control	7-18
7.3.4	Optimization of dynamic response	7-21
7.3.5	Realigning the reference point coordinates	7-24
7.3.6	Activating stepper motor diagnostics	7-25
7.3.7	Activating the software limit switches and backlash compensation	7-26
7.3.8	Optimized motion profile	7-28
8	Human-machine Interface	8-1
8.1	Standard HMI (human-machine interface) for the OP 07 and the OP 17	8-3
8.1.1	Standard user interface for the OP 07	8-5
8.1.2	Standard user interface for the OP 17	8-10
8.2	Analysis of the user DB by the user program for operator control	8-17
8.3	Data block for status messages (DB-SS)	8-20
9	Description of Functions	9-1
9.1	Control and checkback signals	9-2
9.1.1	Control signals	9-3
9.1.2	Checkback signals	9-6
9.1.3	General handling information	9-10

9.2	Operating modes	9-14
9.2.1	Jogging	9-15
9.2.2	Open-loop control	9-18
9.2.3	Reference point approach	9-19
9.2.4	Incremental relative	9-24
9.2.5	MDI (Manual Data Input)	9-27
9.2.6	Automatic	9-31
9.2.7	Automatic single block	9-36
9.3	System data	9-37
9.3.1	Change parameters/data (Write request in user DB, DBX39.3)	9-38
9.3.2	Single functions (user DB, DBB34 and 35)	9-42
9.3.3	Single commands (user DB, DBB36 and 3)	9-44
9.3.4	Zero offset (Write request in the user DB, DBX39.1)	9-46
9.3.5	Set actual value (Write request in the user DB, DBX38.7)	9-48
9.3.6	Set actual value on-the-fly (Write request in the user DB, DBX39.0)	9-49
9.3.7	Request application data (Write request in the user DB, DBX39.6)	9-50
9.3.8	Teach in (Write request in the user DB, DBX39.7)	9-51
9.3.9	Set reference point (Write request in the user DB, DBX38.6)	9-51
9.3.10	Measured values	9-52
9.3.11	Basic operating data (Read request in the user DB, DBX42.0)	9-55
9.3.12	Active NC block (Read request in the user DB, DBX42.1), next NC block (Read request in the user DB, DBX42.2)	9-56
9.3.13	Application data (Read request in the user DB, DBX43.6)	9-57
9.3.14	Actual value block change (Read request in the user DB, DBX42.3)	9-57
9.3.15	Servicing data (Read request in the user DB, DBX42.4)	9-57
9.3.16	Additional operating data (Read request in the user DB, DBX43.5)	9-58
9.3.17	Parameters/data (Read request in the user DB, DBX43.3)	9-58
9.4	System of measurement	9-59
9.5	Axis type	9-60
9.6	Determining the position	9-63
9.6.1	Synchronizing the stepper motor axis	9-64
9.7	Stepper motor control system	9-66
9.7.1	Frequency generation	9-69
9.7.2	Drive interface	9-71
9.7.3	Rotation monitoring	9-75
9.8	Digital inputs/outputs (Read request user DB, DBX43.4)	9-77
9.8.1	Function description for digital inputs	9-78
9.8.2	Function description for digital outputs (Write request in the user DB, DBX39.4)	9-79
9.9	Software limit switches	9-80
9.10	Process interrupts	9-81
10	Writing Traversing Programs	10-1
10.1	Traversing blocks	10-2
10.2	Program execution and direction of processing	10-16
10.3	Block transitions	10-16

11	Troubleshooting	11-1
11.1	Error classes and module responses	11-3
11.2	Error messages	11-4
11.2.1	Fault indication by LED	11-4
11.2.2	Diagnostic interrupts	11-6
11.2.3	Error messages in checkback signals	11-7
11.2.4	Message in data block	11-8
11.2.5	Viewing the diagnostic buffer (PG/PC)	11-8
11.3	Error lists	11-9
11.3.1	Diagnostic interrupts	11-9
11.3.2	Error messages	11-13
A	Technical Specifications	A-1
B	User Data Block (AW-DB)	B-1
C	List of Abbreviations	C-1
	Index	Index-1

Product Overview

1

Chapter overview

Section	Section Header	Page
1.1	The FM 353 in the S7-300 programmable controller	1-2
1.2	Module description	1-7
1.3	Overview of the module functions	1-9

What can the FM 353 do?

The FM 353 is a microprocessor-controlled positioning module for actuating a step-per motor.

The FM 353 is a high-performance module for positioning with stepper drives.

The module works autonomously and is controlled by way of the user program in the SIMATIC S7-300 system.

It can operate rotary and linear axes.

The FM 353 has a variety of operating modes.

The module has a non-volatile data memory to store parameterization data.

- The FM 353 is low-maintenance (no battery).
- It can be linked and adapted to user circumstances by parameterizing it as required by the system.

Where can the FM 353 be used?

The FM 353 can be used for both simple positioning and complex traversing profiles demanding superior dynamic response, accuracy and speed. It is also suitable for positioning tasks in machinery with high clock-pulse rates.

Typical uses for the positioning module might include:

- Transfer lines
- Assembly lines
- Woodworking machines
- Handling equipment
- Loaders
- Auxiliary movements in milling and turning machines
- Packaging machines
- Conveyor equipment

Its range of functions is comparable to that of the WF 721 module in the SIMATIC S5 system, and the FM 354 in the SIMATIC S7 system.

1.1 The FM 353 in the S7-300 programmable controller

How is the FM 353 linked up with the S7-300?

The FM 353 is designed as a function module of the SIMATIC S7-300 controller.

The S7-300 programmable controller consists of a CPU and a variety of peripheral modules mounted on a mounting rail.

The configuration may have one or more racks.

Multi-rack configurations

A SIMATIC S7-300 CPU may run up to four racks with as many as eight bus stations each (see Figure 1-1).

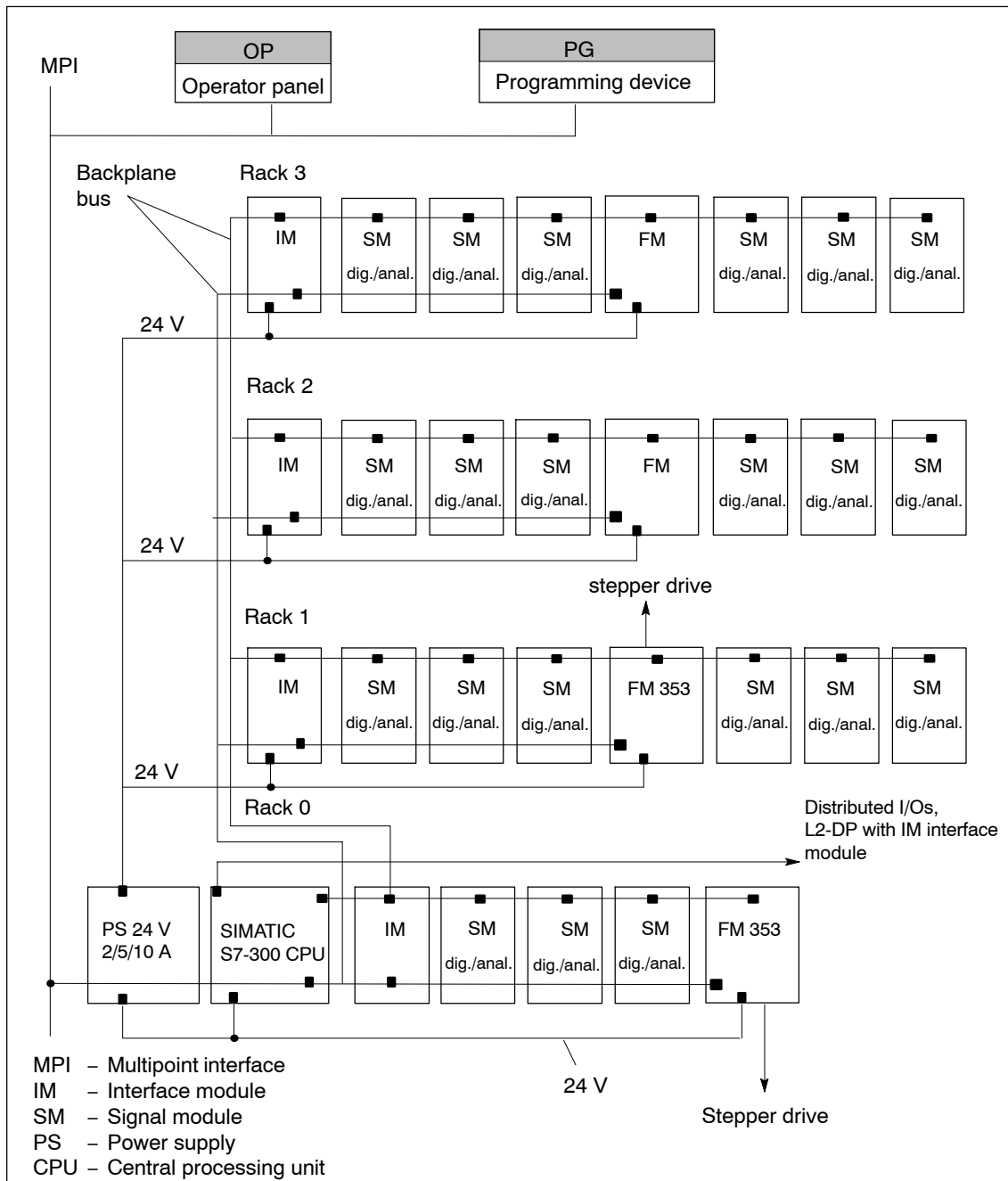

Fig. 1-1 Multi-rack configuration of a SIMATIC S7-300 with FM 353 (example)

System overview

A complete positioning controller using the FM 353 consists of a variety of individual components, which are shown in Figure 1-2.

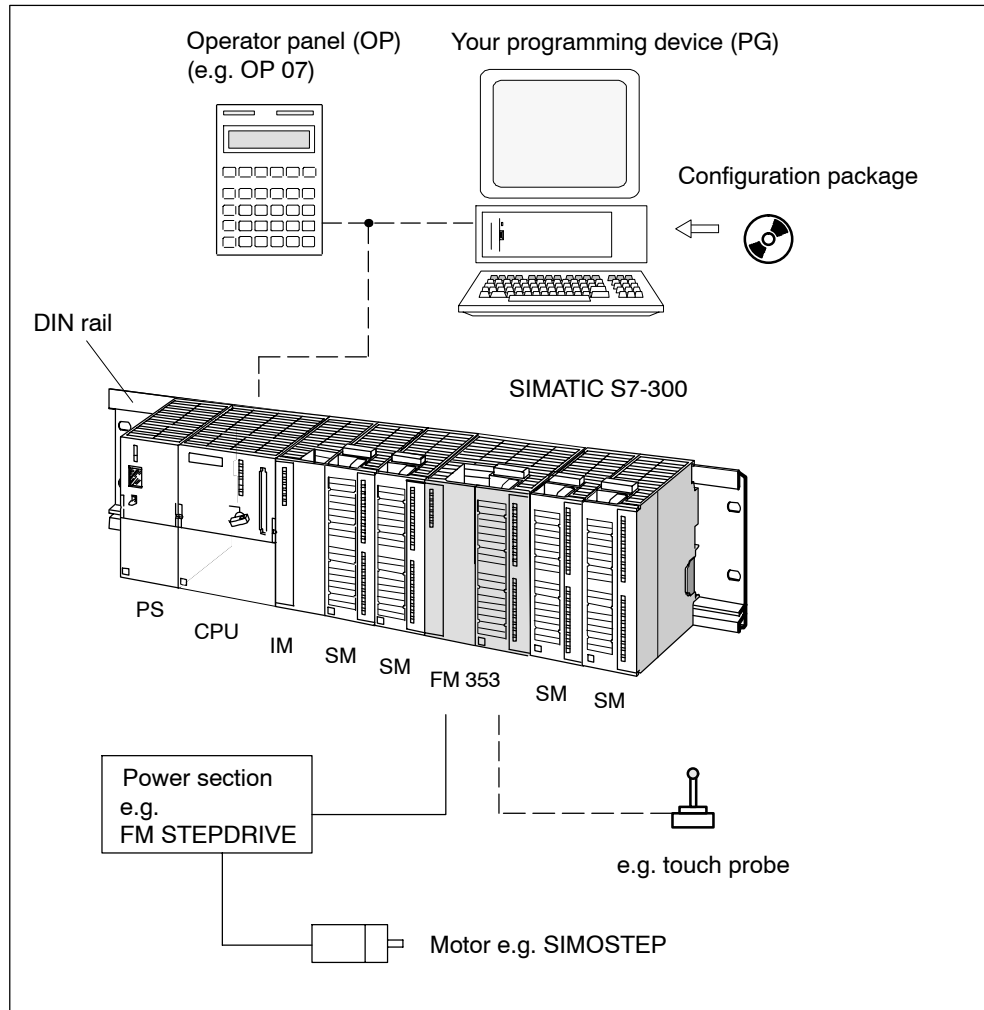

Fig. 1-2 System overview (schematic)

MPI connection

The FM can service up to 3 MPI nodes (PCs, programming devices or OPs) simultaneously.

Components

The most important components and their functions are listed in Table 1-1.

Table 1-1 Components of a positioning controller

Component	Function
DIN rail	... the module mounting rack for the S7-300.
FM 353	... the positioning module. It is controlled by the S7-300 CPU.
CPU	... executes the user program; powers the S7-300 backplane bus at 5 V; and communicates with the programming device and the operator panel via the MPI interface.
Power supply (PS)	... converts line voltage (120/230 V AC) to 24 V DC operating voltage to power the S7-300.
Signal modules (SM)	... adapts various process-signal levels to the S7-300
Interface module (IM)	... connects the individual cells of an S7-300 with one another (applies to multi-rack configuration; see Figure 1-1).
Programming device (PG)	... configures, parameterizes, programs and tests the S7-300 and the FM 353.
Operator panel (OP)	... the interface to the machine. It serves for operation and monitoring. It is not an absolute prerequisite for operation of an FM 353.
Power section	... actuates the motor.
Motor	... drives the axis.
Configuration package	<p>... A CD-ROM containing:</p> <ul style="list-style-type: none"> • An FC block package • MD DBs (for start-up of stepper motor) • The parameterization tool "Parameterize FM 353" • A preconfigured operator interface for the COROS series OP 07 and OP 17 • A manual in PDF format • Getting Started in PDF format

System overview of data handling

The following figure gives you an overview of the data storage concept.

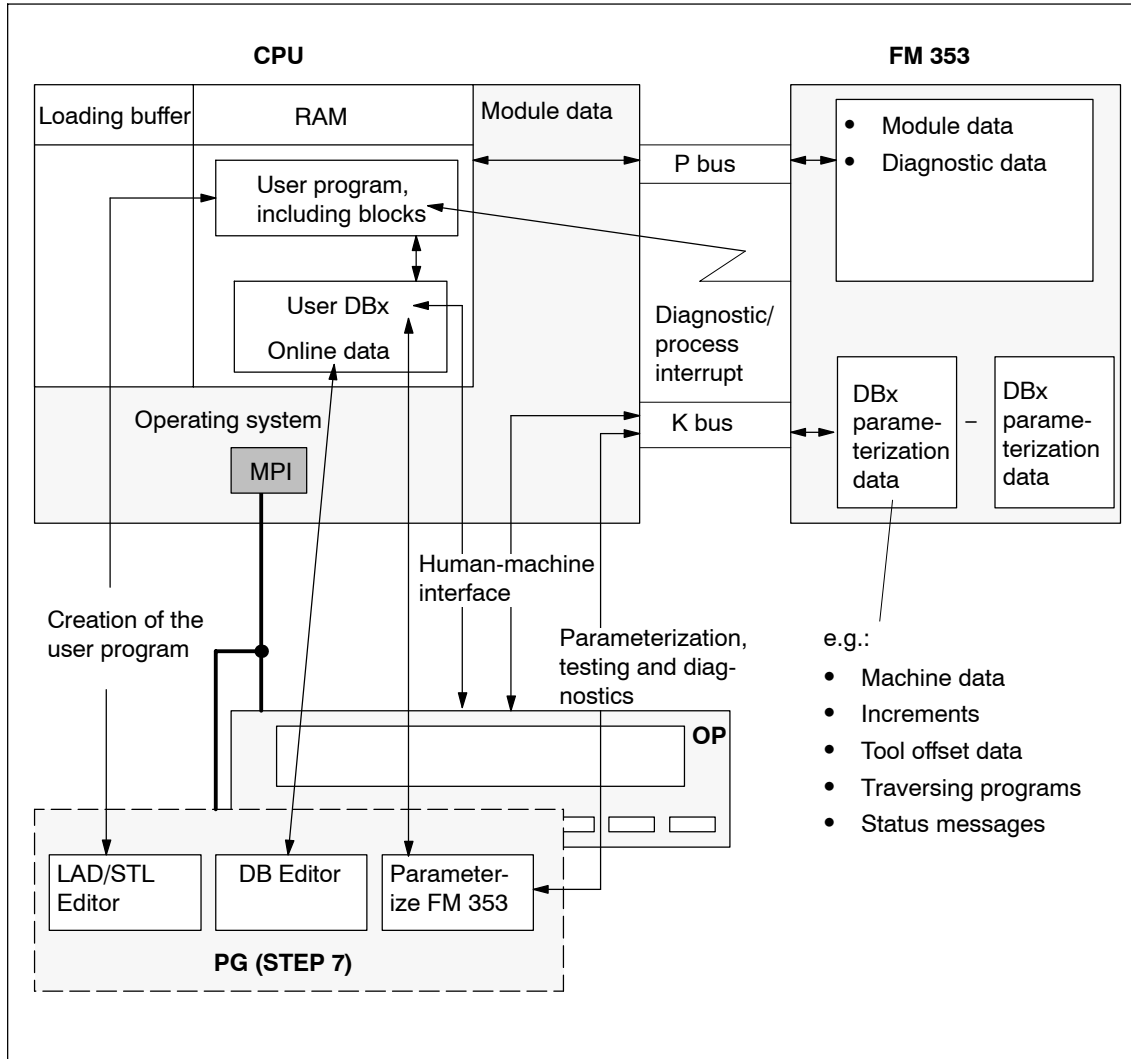

Fig. 1-3 Data storage concept

1.2 Module description

View of the FM 353

Figure 1-4 shows the FM 353 module, its interfaces and front-panel elements (including fault and status displays).

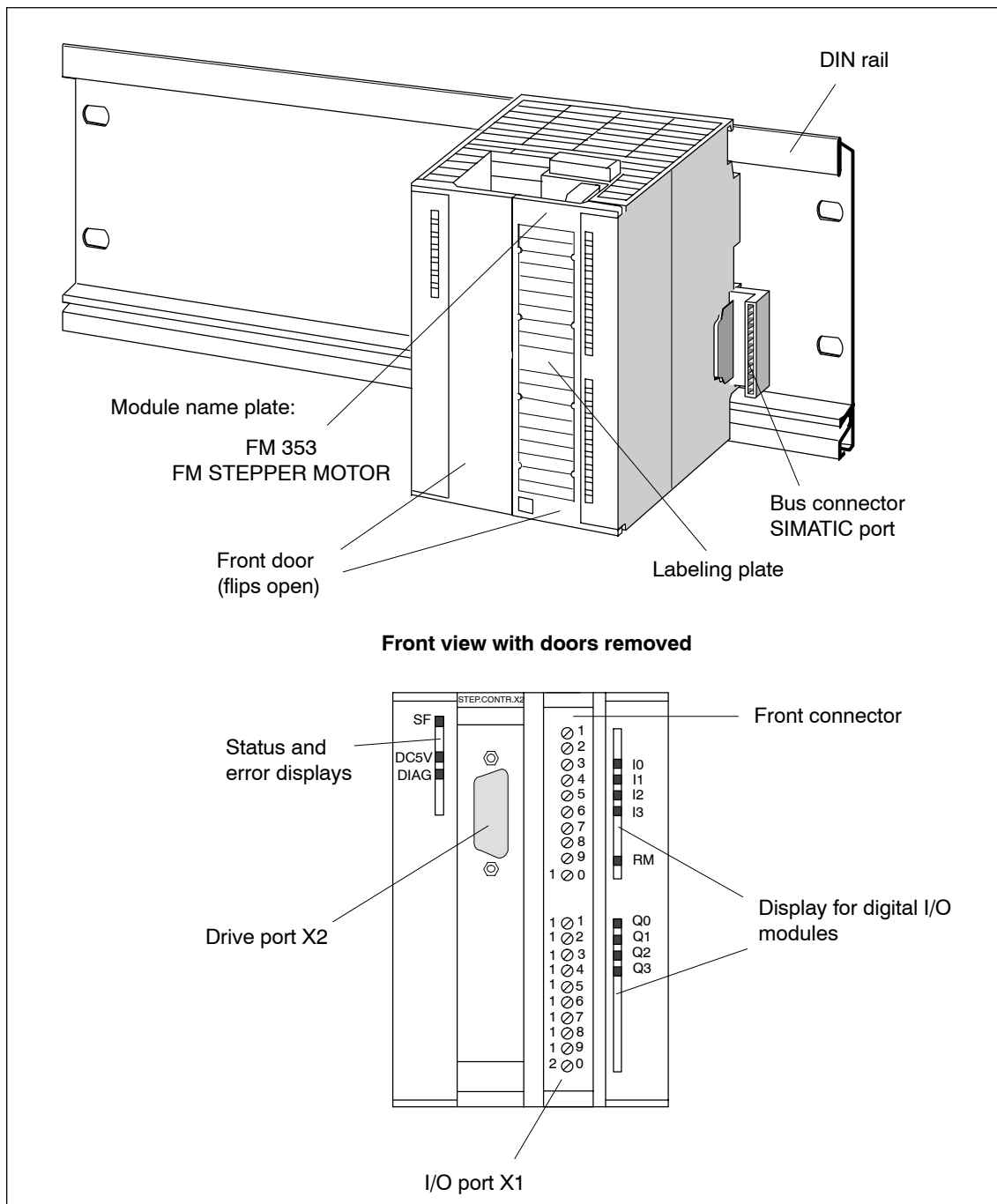

Fig. 1-4 View of the FM353

Ports

A description of the ports is provided in Table 1-2.

Table 1-2 Ports

Ports	Description
Bus connector – SIMATIC port	Back connector to continue the S7 LAN from module to module
Drive port	15-pin male sub-D connector (X2) to connect the drive unit
I/O port	20-pin male front connector (X1) to connect the load power supply and for digital input and output wiring

LED indicators

Twelve LEDs are arranged on the front panel of the FM 353. Table 1-3 describes these LEDs and what they mean.

Table 1-3 Status and error displays

LED	Significance
SF (red) - Group error	This LED indicates an error condition in the FM 353. (see Troubleshooting, Chapter 11)
5 V DC (green) - Logic power supply is ON	This LED indicates that the hardware is ready for operation.
DIAG (yellow) - Diagnostics	This LED indicates various diagnostic states (see Troubleshooting, Chapter 11)
I0 – I3 (green) - Digital inputs	These LEDs indicate which input is ON.
Q0 – Q3 (green) - Digital outputs	These LEDs indicate which output is ON.
RM (green) - Input, controller message	This LED indicates that the input is activated. (see Section 4.4)

Type plate of the FM 353

Figure 1-5 describes all the information contained in the type plate of the FM 353.

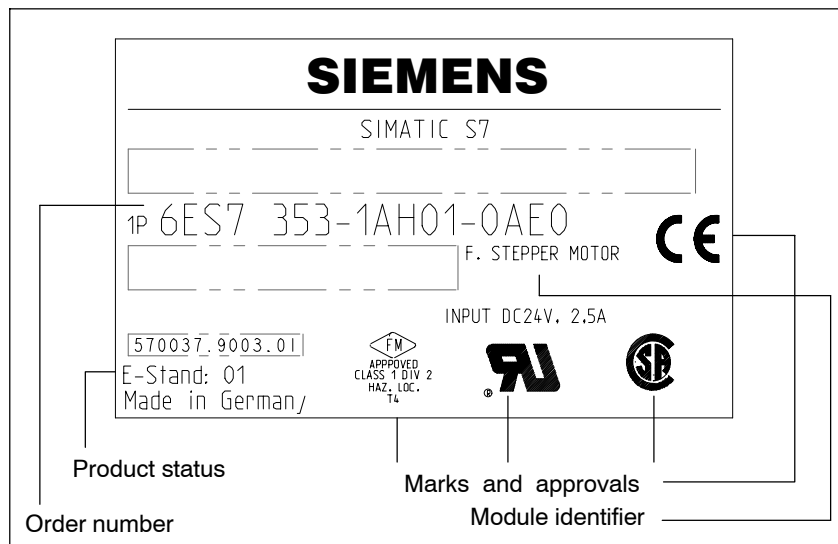

Fig. 1-5 Type plate of the FM 353

1.3 Overview of module functions

Summary

The FM 353 module performs the following functions:

- Mode control
- Determining position
- Stepper motor control
- Digital inputs and outputs
- Settings and functions that do not depend on operating mode
- Software limit switches
- Process interrupts
- Block sequence control
- Diagnostics and troubleshooting
- Data storage on the FM 353

Mode control

The operating mode is specified to the FM 353 by way of the user program.

The FM 353 has the following modes available:

- Jogging
- Open-loop control
- Reference point approach
- Incremental mode, relative
- MDI-Manual Data Input)
- Automatic
- Automatic single block

Determining position

The control frequency pulses emitted by the FM 353 are added internally to form a position actual value.

Stepper motor control

The stepper motor control performs the following tasks:

- Guidance of the drive commensurate with speed during movement sequence (e.g. adjustable acceleration and delay, start/stop operation)
- Output of step pulses in form of control frequency
- Output of a direction signal
- Accurate approach by axis into programmed target position
- Phase current control to the drive device

Digital inputs/outputs

Four digital inputs and four outputs can be used as specified by the user.

You might connect:

- Reference-point switches
- Switches for external starting
- Touch probes
- Position reached, Stop (“PEH”)
- Forward/backward rotation

The switching function is assigned to a given I/O number by way of the machine data.

Settings and functions not dependent on operating mode

Special functions can be activated by specific settings in the user program, in addition to the mode (e.g., inprocess measurement).

Software limit switches

The operating range (specified by software limit switches) is automatically monitored after synchronization is recorded.

Process interrupts

Process interrupts are triggered by such events as:

- Position reached
- Length measurement completed
- On-the-fly block change
- Inprocess measurement

Process interrupts are selected by way of machine data.

Block sequence control

Automatic processing of a traversing program, including subprograms created during the parameterization process. A number of traversing programs are available for execution on the module.

Diagnostics and troubleshooting

Startup and ongoing operation of the module are monitored by fault and diagnostic interrupts. Faults or errors are reported to the system and displayed by the LEDs on the module.

Data storage on the FM 353

Parameterization data (machine data, tool compensation data, traversing programs and increment sizes) is retained in storage on the FM 353.



Basic Principles of Positioning

What is positioning?

Positioning means moving a load to a defined position within a defined time, taking all influencing forces and torques into account.

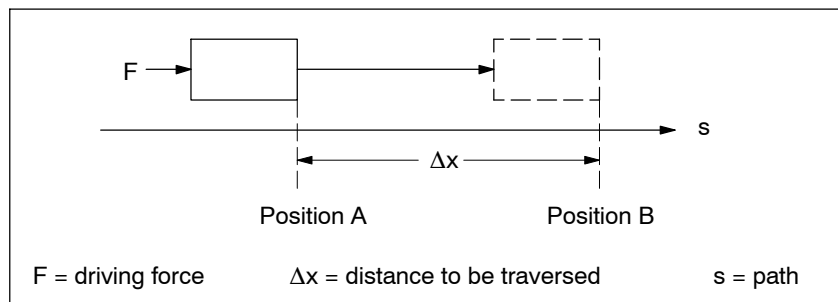

Fig. 2-1 Principle of a positioning action

What is servo-controlled positioning?

Servo-controlled positioning with a stepper motor is:

- Control of the drive at the right speed while a movement is being performed.
- Specifying a target position and true-to-target axis approach into programmed target position

Structure of a positioning circuit

Figure 2-2 show the structure of a position control circuit with FM 353 and stepper motor.

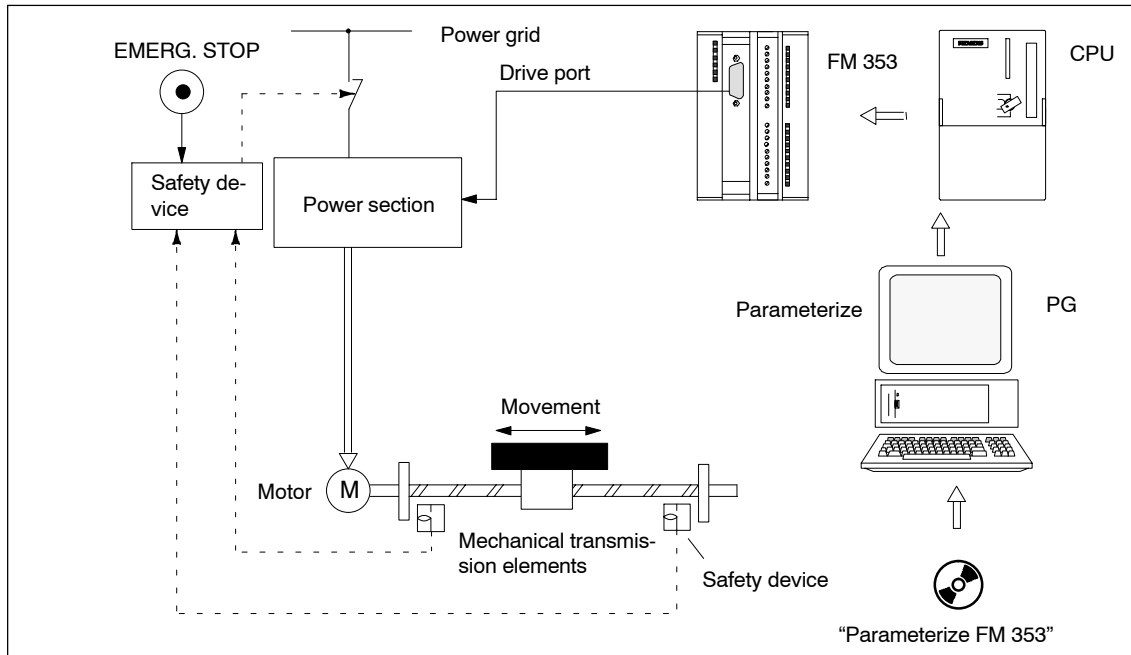

Fig. 2-2 Setup of positioning with stepper motor (example)

FM 353

The FM 353 generates the following for the power section:

- Control frequency
- Direction signal
- Special control signals

Power section

The power section processes the control signals and supplies power to the motor.

Motor

The motor is connected, either directly or by way of mechanical transmission elements, to the machine component to be moved.

Mechanical transmission elements

These include not only the axis, but also gear trains and clutch systems.

Peripherals

All other additional equipment is covered by the term peripherals.

Peripherals mainly include:

- Limit switches to limit the positioning range (safety devices).
- A programming device (PG) and the “Parameterize FM 353” parameterization software.



3

Installing and Removing

Chapter Overview

Section	Section Header	Page
3.1	Installing the FM 353	3-3
3.2	Removing the FM 353	3-4
3.3	Replacing modules	3-5

Overview

The FM 353 is intended for installation as an I/O module in the SIMATIC S7-300 programmable logic controller.

Important safety rules

There are important rules which you must follow when integrating an FM 353 in the S7-300 PLC in a plant or system.

These rules and specifications are described in the installation manual *S7-300 Programmable Controller, Hardware and Installation*.

Mechanical set-up

The options for the mechanical set-up and its configuration are described in the manual *S7-300 Programmable Controller; Hardware and Installation*.

Below, we give only a few supplementary pointers.

Installation position

The module should preferably be installed horizontally.

In vertical installations, please observe the ambient temperature restrictions (max. 40 °C).

What you should know about the mechanical layout

The FM 353 can be mounted in any of the eight available slots (slot nos.: 4...11) for I/O modules on the mounting rail.

In configuring the mechanical layout of your controller, you should note the following rules:

1. No more than eight SMs or FMs per tier (rack).
2. The maximum number of modules is limited by module width and by the length of your DIN rail.

The FM 353 requires an installation width of 80 mm (3.12 inches).

3. The maximum number of modules is limited by the total power that all modules to the left of the CPU or IM, as the case may be, consume from the 5 V back-plane bus.

The CPU 314, for example, can supply a maximum of 1.2 A.

The FM 353 requires 100 mA of this amount.

3.1 Installing the FM 353

Rules

No particular protective measures (EGB Guidelines) are necessary for the installation of the FM 353.



Warning

Install the FM 353 only after all power to the S7-300 has been turned OFF.

Tools required

A 4.5 mm (.18 inch) screwdriver.

Procedure

To install the FM 353:

1. The FM 353 comes with a bus connector. Plug this into the bus plug of the module to the left of the FM 353. (The bus plug is on the back; you may have to loosen the module already in place.)

If further modules are to be mounted to the right, plug the bus connector of the next module into the right backplane bus connector on the FM 353.

If the FM 353 is the last module in the rack, do not connect this bus connector.

2. Hook the FM 353 onto the rail and swing it down into position.
3. Screw the FM 353 down (torque approx. 80-110 Nm).
4. After the modules have been mounted, you can also assign each of them a slot number. Slot labels for this purpose are enclosed with the CPU.

The numbering scheme and how to plug in the slot labels are described in the installation manual *S7-300 Programmable Controller, Hardware and Installation*, for the numbering scheme to follow and how to apply the slot labels.

Note

The slot determines the initial address of each module. To find out how to allocate the module start address, please refer to the installation manual *S7-300 Programmable Controller, Hardware and Installation*, Order No.: 6ES7 030-0AA01-8AA0.

The FM 353 is addressed in the same way as an analog module.

3.2 Removing the FM 353

Rules

No particular protective measures (EGB Guidelines) are necessary for the removal of the FM 353.



Warning

Remove the FM 353 only after all power to the S7-300 has been turned OFF.

Tools required

A 4.5 mm (.18 inch) screwdriver.

Procedure

To remove the FM 353:

1. Open the front doors. If necessary, remove the labeling strips.
2. Detach the power-supply connections from the terminal block.
3. Detach the sub-D plug from the drive unit.
4. Release the protective device on the front connector and unplug it.
5. Loosen the fastening screws and swing the module up and out.

3.3 Replacing modules

Overview

If a defective FM 353 has to be replaced, and no programming device/PC is available for parameterization, or the module is to be replaced while the system is switched on, please note the following start-up requirements (CPU, FM):

- An SDB $\geq 1\,000$ should be generated in order to complete the startup (for storing the parameter data); see Section 5.5.
- In the user program:
 - Interrupt communication with the FM 353 before removing the old FM, and resume communication after installing the new FM.
 - If data/parameters are modified during operation and stored retentively on the FM, please follow the instructions in Section 9.3.1.

Replacing an FM 353

To replace a parameterized but defective FM 353:

1. Replace the FM 353 when the system is switched off (CPU, FM)

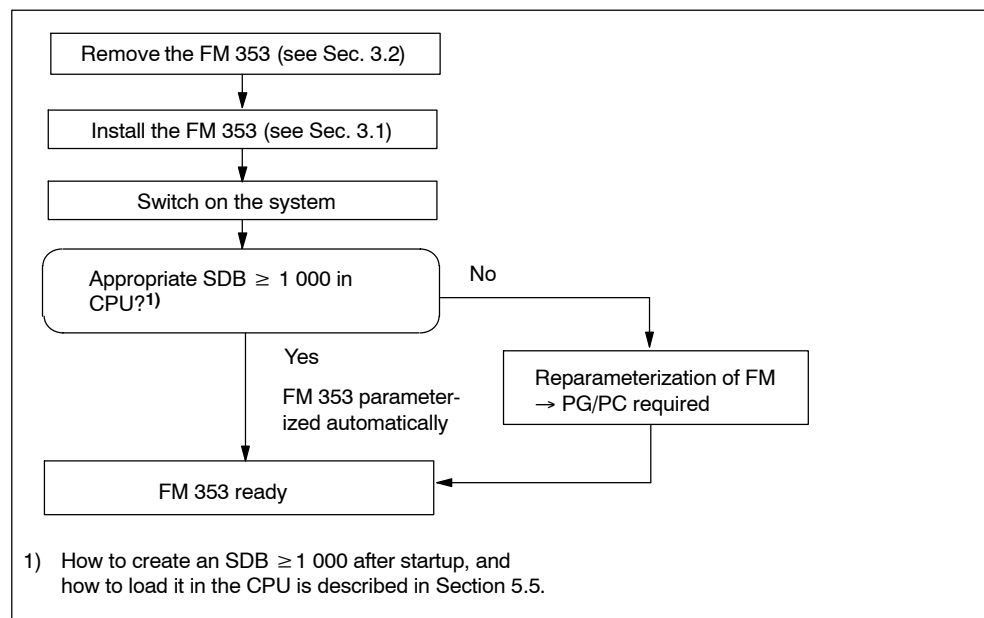

Fig. 3-1 Replacing the FM 353 with the system switched off

Wiring

4

Chapter Overview

Section	Section Header	Page
4.1	Wiring an FM 353	4-2
4.2	Description of the drive interface	4-4
4.3	Connecting the drive unit	4-11
4.4	Description of the I/O interface	4-12
4.5	Wiring up the front connector	4-18

Safety rules

In order to ensure the safe operation of your plant, you should introduce the following additional measures, and adjust them appropriately to your system's conditions:

- An EMERGENCY STOP concept meeting appropriate safety regulations (e.g. European standards EN 60204, EN 418 and associated standards).
- Additional measures for limiting the end position of axes (e.g. hardware limit switches).
- Equipment and measures for protecting the motors and power electronics in accordance with the installation guidelines for FM STEPDRIVE/SIMOSTEP.

We also recommend you carry out a risk analysis in accordance with basic safety requirements / Appendix 1 of the EC machine directive, in order to identify sources of danger affecting the complete system.

Further references

Please refer also to the following chapters in the manual *S7-300 Programmable Controller, Hardware and Installation*:

- Lightning protection and overvoltage protection: Chapter 4.2
- Guidelines for handling of electrostatic sensitive devices (ESDs): Appendix B.
- Configuring the electrical installation: Chapter 4.

For further information about EMC guidelines, we recommend the description in: *Equipment for Machine Tools, EMC guidelines for WS/WF equipment*, Order No.: 6ZB5 440-0QX01-0BA1.

Standards and specifications

When wiring the FM 353 you must observe the relevant VDE guidelines.

4.1 Wiring an FM 353

Summary

Figure 4-1 shows how the individual components of the positioning controller with FM 353 are linked together.

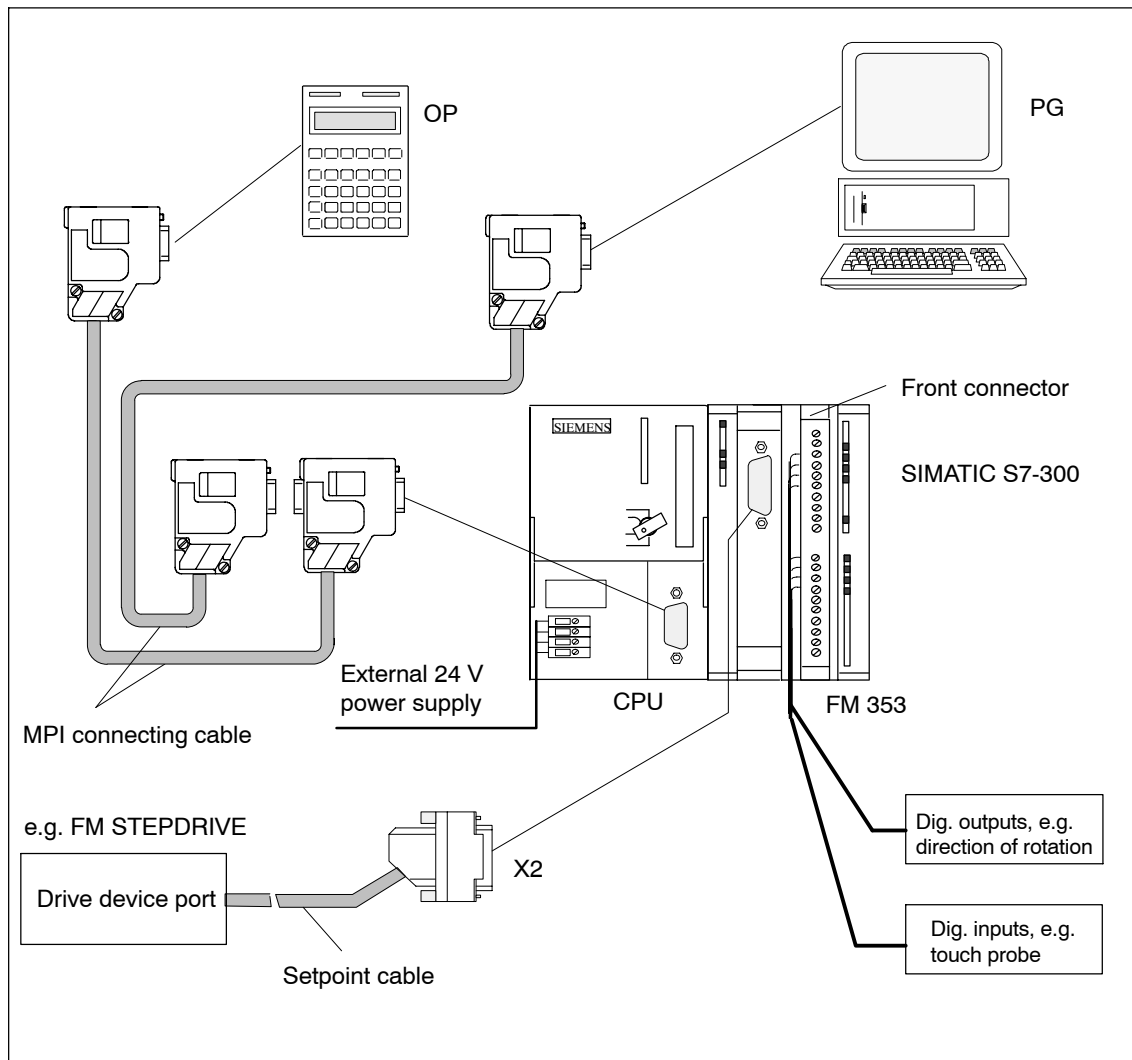

Fig. 4-1 Wiring an FM 353

Note

The device is designed for operation with safety extra–low voltage (SELV). This means that only safety extra–low voltages (SELV) complying with IEC950/EN60950/VDE0805 may be connected to the power supply terminals. The power unit for supplying the device must comply with NEC Class 2 as described by the National Electrical Code(r) (ANSI/NFPA 70). The power of all connected power units in total must correspond to a limited power source (LPS).

Connecting cables

Table 4-1 lists the connecting cables for a positioning controller with the FM 353.

Table 4-1 Connecting cables for a positioning controller with FM 353

Type	Order No.	Description
MPI connecting cable	see <i>Catalog ST 70</i> , Order No. E86060-K4670-A101-A□	Connection between OP, PG and S7-300 CPU
Setpoint cable	6FX2 002-3AC02-1□□0 see <i>Catalog NC Z</i> Order No.: E86060-K4490-A001-A□	Connection between FM 353 and stepper drive

Front connector

You need a 20-pin screw-type front connector for wiring the digital I/Os. It must be ordered separately.

Order No.: 6ES7 392-1AJ00-0AA0

see *Catalog ST 70*, Order No. E86060-K4670-A101-A□

see *Catalog NC 60.1*, Order No. E86060-K4460-A101-A□

4.2 Description of the drive interface

Connector for the drive unit

Stepper motor power sections which have at least one clock generator and direction input with 5 V signal level can be connected to the 15-pin sub-D X2 connector of the FM 353.

Additionally, the FM 353 provides an enable signal.

Connector position

Figure 4-2 shows the installation position and identification of the plug on the module.

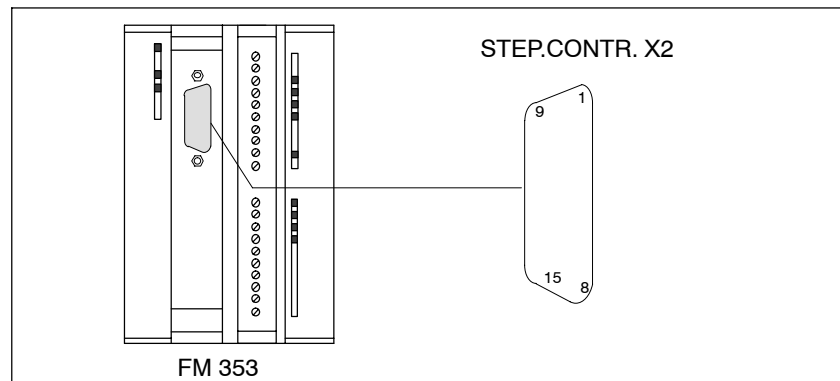

Fig. 4-2 Position of X2 connector

Connector pinout

Connector identifier: **X2** **STEP.CONTR.X2**
 Connector type: 15-pin sub-D plug connector

Table 4-2 Pinout of the X2 connector

Pin	Name	Type	Pin	Name	Type
1	PULSE	O	9	PULSE_N	O
2	DIR	O	10	DIR_N	O
3	ENABLE	O	11	ENABLE_N	O
4	PWM / BOOST	O	12	PWM_N / BOOST_N	O
5	GND	O	13	GND	O
6	GND	O	14	GND	O
7	not assigned		15	READY1_N	I
8	GND	O			

Signal names

PULSE, PULSE_NC	Lock signal, true and negated
DIR, DIR_N	Direction signal, true and negated
ENABLE, ENABLE_N	Enable signal, true and negated
PWM/BOOST, PWM_N/BOOST_N	Current control, true and negated
READY1_N	Ready message
GND	Signal ground

Signal type

O	Output
I	Input

Note

The active level of each signal can be defined in MD37 (see Section 5.3.1, 9.7). Check the technical documentation for your drive device regarding assignment of signal levels to direction of rotation.

Output signals

Clock, directional and enable signals are provided. In addition, an additional signal can be parameterized for current generation.

- **PULSE**

The clock pulses control the motor. The motor executes one increment in response to each rising pulse edge.

This means that the number of pulses which are output determines the angle of rotation, i.e. the distance to be traversed.

The pulse frequency determines the speed of rotation, i.e. the traversing speed.

- **DIRECTION**

The signal levels which are output determine the direction of rotation of the motor.

Signal ON: "Rotation to left"

Signal OFF: "Rotation to right"

- **ENABLE**

The FM 353 activates this signal anytime the cyclical control operating mode is detected.

Signal ON: Power activation is enabled

Signal OFF: Depending on power section, one or more of the responses mentioned may occur:

- Disable pulse input
- Switch off power to motor
- Reset ring counter
- Erase error messages

- **PWM / BOOST**

This signal is for purposes of altering the motor current.

In the "PWM" function, a pulse width modulated signal is output which can be used to adjust the motor current between 0 and 100%.

The "BOOST" function can be used to amplify the motor current:

Signal ON: Motor current increases

Signal OFF: Motor current normal

The use of this signal must be defined in the machine data (see MD37, Section 5.3.1, 9.7.2).

Signal parameters of the outputs

All output signals are output by way of differential-signal line drivers in compliance with Standard RS422. To ensure optimum noise immunity, the power section should feature differential signal receivers or optical coupler inputs to permit balanced signal transfer. Unbalanced transfer is also possible, however cable length in such cases is limited to a maximum of 10 m.

Note

In the case of asymmetrical transmission satisfactory functioning cannot be guaranteed because of the various non-standardized input circuits of the drive units. Especially the lead length and the limit frequency depend on the properties of the input circuit and the lead used. Furthermore, the reference potential GND must be floating in order to prevent electrical interference.

Table 4-3 provides a summary of the output signal electrical data.

Table 4-3 Electrical parameters of the stepper drive signal outputs

Parameters		min	max	Unit	when
Differential output voltage	V_{OD}	2		V	$R_L = 100 \Omega$
Output voltage "High"	V_{OH}	3,7		V	$I_O = -20 \text{ mA}$
		4,5		V	$I_O = -100 \mu\text{A}$
Output voltage "Low"	V_{OL}		1	V	$I_O = 20 \text{ mA}$
Load resistance	R_L	55		Ω	
Output current	I_O		± 60	mA	
Pulse frequency	f_p		200	kHz	

Connecting cable to drive

allowable length (l):
 for balanced transfer, 35 m
 for unbalanced transfer, 10 m

Signal wiring (output signals)

Figure 4-3 shows various ways to wire the signals.

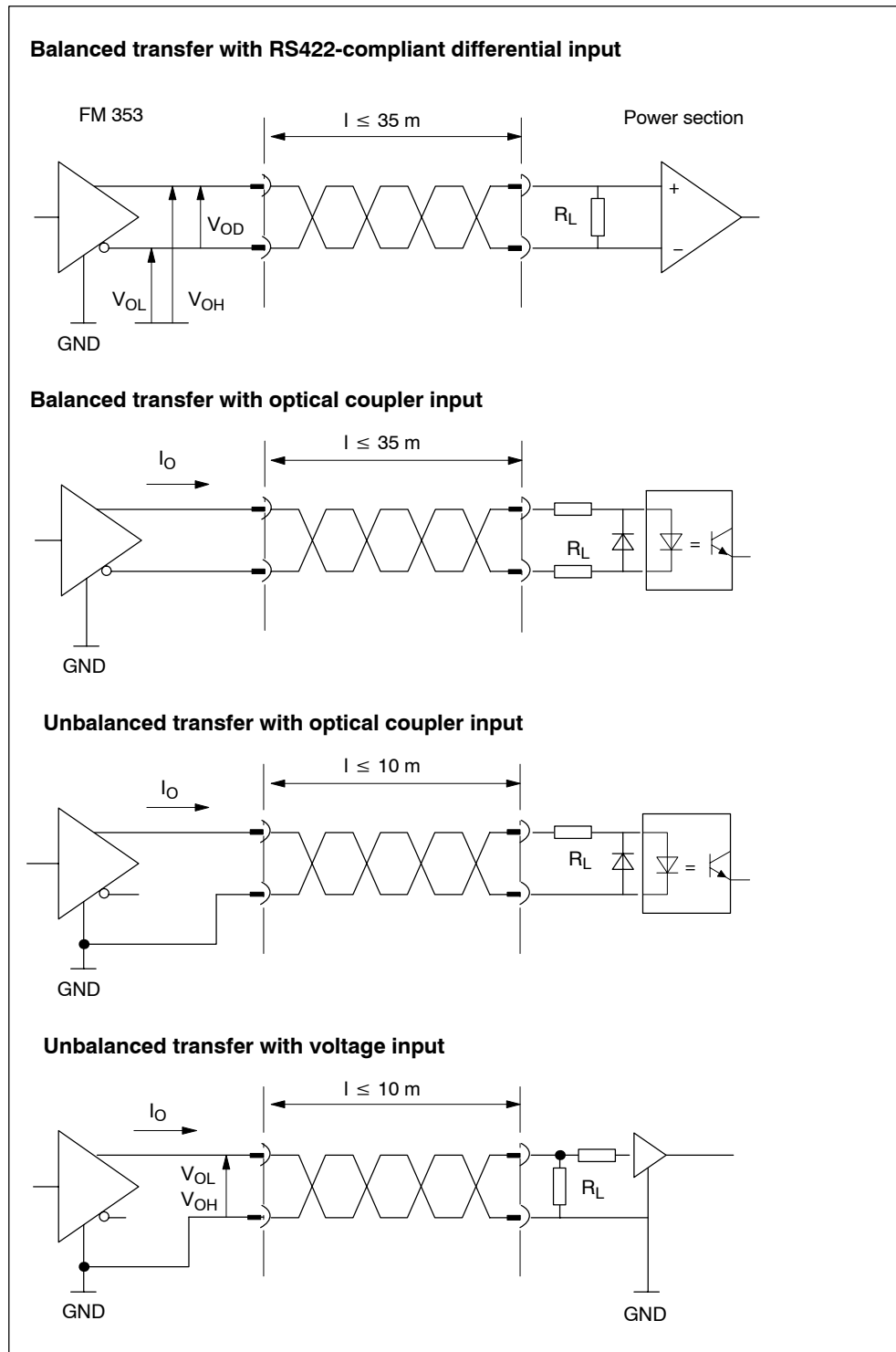

Fig. 4-3 Connection options for drive port output signals.

Input signal

READY1_N

This input is non-isolated and works with a 5V level. A floating output (switching contact or optical coupler) may be connected. The FM 353 interprets this input as a Ready message from the power section.

An alternative connection option is available by way of peripherals connector X1 (see Section 4.4).

Its use is defined in machine data (see MD37, Section 5.3.1, 9.7.2).

Signal parameters of the input

Table 4-4 presents a summary of the electrical parameters of the input signal.

Table 4-4 Electrical parameters of the "READY1_N" signal input

Parameters		Value	Unit	Comment
1 Signal, voltage range	V_H	3.5...5.5	V	or input open
0 signal, voltage range	V_L	-1.5...2	V	
0 signal, input current	I_L	-1.5...-3	mA	

Signal connection for the “READY1_N” input

The illustration shows you different signal connection options for the “READY1_N” input.

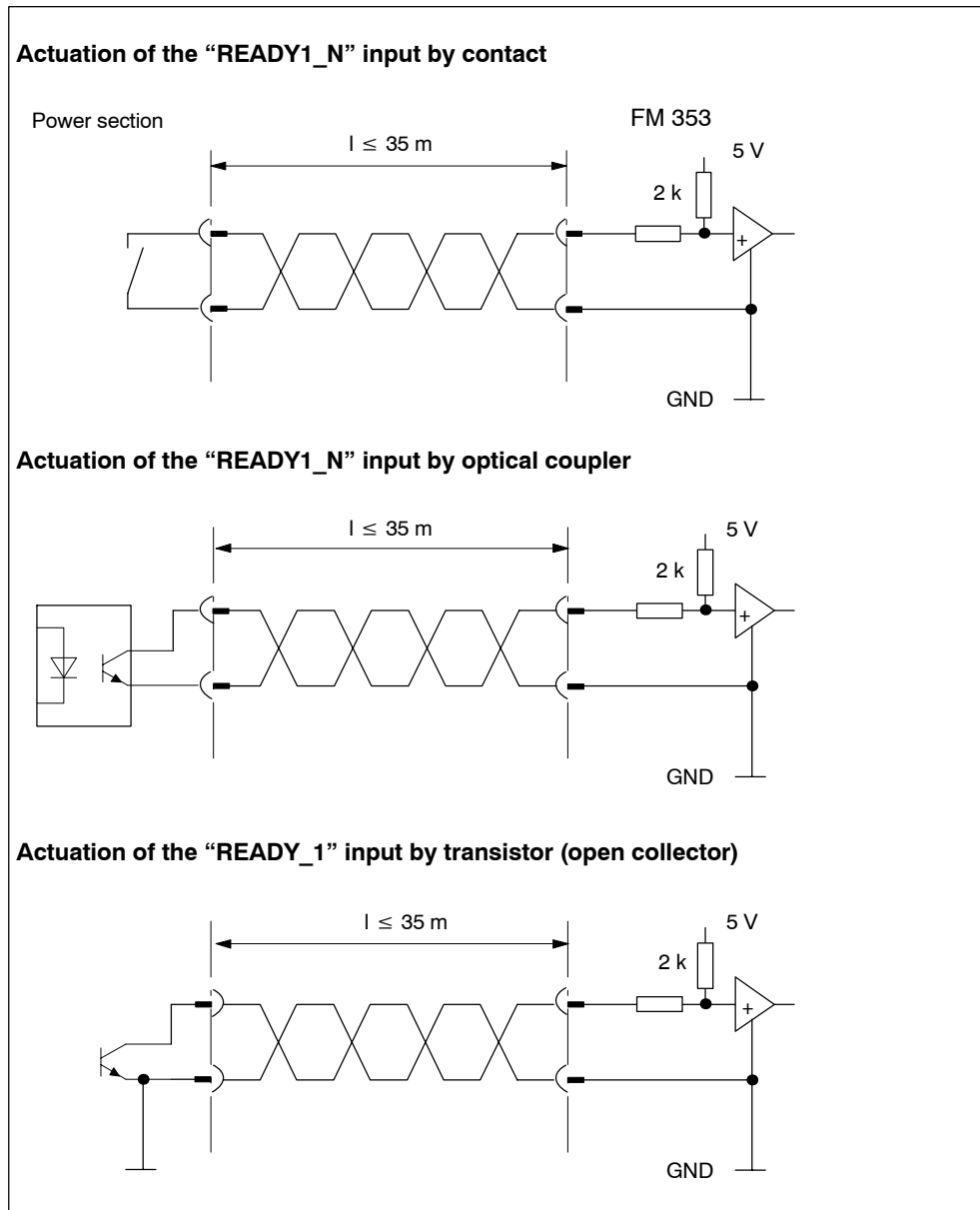

Fig. 4-4 Connection of the “READY1_N” input

4.3 Connecting the drive unit

To connect the connecting cables

Please note:

Note

Use only shielded twisted pairs for lines. The shielding must be connected to the metallic or metallized connector jacket on the controller side. To protect the analog setpoint signal against low-frequency interference, we recommend that you not ground the shielding on the drive-unit side.

The cable set supplied as an accessory offers excellent immunity against interference.

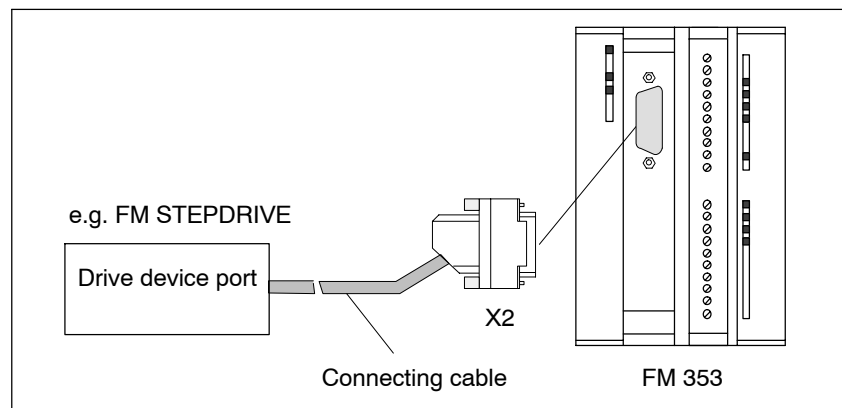

Fig. 4-5 Connecting a drive unit

Procedure to connect the connecting cable

Connect the drive unit as follows:

1. Wire the free cable end of the connecting cable to the terminals of the drive unit.
2. Open the front door and plug the sub-D connector into the module.
3. Lock the connector in place with the knurled screws. Close the front door.

Identification of the connecting cable

The connecting cable is a cable set for one axis with an analog interface. The terminals are identified for SIMODRIVE drive units.

Order No.: 6FX2 002-3AC01-1□□0

The connecting cable is available in a variety of lengths.

see *Catalog NC Z* , Order No.: E86060-K4490-A001-A□.

4.4 Description of the I/O interface

Front connector

Four digital inputs/outputs and one message signal from the power section may be connected to the 20-pin front connector X1 with its single-wire terminal.

Location of connector

Figure 4-6 shows the front connector in position to be wired, and the labeling on the inside of the front door.

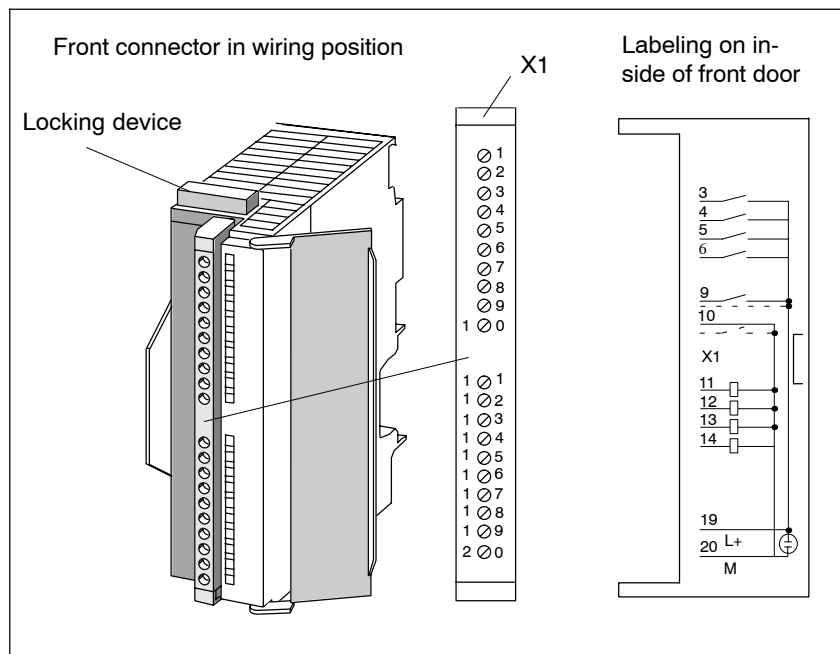

Fig. 4-6 Location of X1 connector

Connector pinout

Connector identifier: **X1**
 Connector type: 20-pin S7 front connector for single-wire terminal

Table 4-5 Pinout of the X1 connector

Pin	Name	Type	Pin	Name	Type
1	open	VI	11	DO1	Q
2	not assigned	VI	12	DO2	Q
3	DI1	I	13	DO3	Q
4	DI2	I	14	DO4	Q
5	DI3	I	15	not assigned	
6	DI4	I	16	not assigned	
7	open		17	not assigned	
8	open		18	not assigned	
9	RM_P	I	19	L+	VI
10	RM_N	I	20	M	VI

Signal names

DI1 – 4 Digital input 1 – 4
 DQ1 – 4 Digital output 1 – 4
 RM_P Positive input for controller message
 RM_N Negative input for controller message
 L+, M 24 V load power supply / ground

Signal type

Q Output
 I Input
 VI Voltage input

4 digital inputs (DI1...4)

All inputs have equal priority. Switching functions are allocated to an input number by way of machine data; input polarity is selected in the same way (starting and shutdown slopes).

These fast inputs are PLC-compatible (24 V current-sourcing). Switches or contactless sensors (2-wire or 3-wire sensors) can be connected.

Possible uses include:

- As reference-point switches
- As switches for external Start/Stop, external block change
- As touch probes

See Section 5.3.1 for further applications.

Table 4-6 Electrical parameters of digital inputs

Parameters	Value	Unit	Comment
1 signal, voltage range	11 – 30	V	
1 signal, power consumption	6 – 15	mA	
0 signal, voltage range	-3 – 5	V	or input open
Signal delay 0 → 1	15	µs	
Signal delay 1 → 0	150	µs	

“Controller message” (RM) input

One message signal from the drive power section can be connected to the “RM_P/RM_N” terminals.

The message signal is specified in MD37 (see Section 5.3.1) and can be one of the following (see Section 9.7):

- Servo controller ready (alternative to connector X2)
- Current-sourcing pattern zero signal for reference point approach
- Zero pulse, external (e.g. reference point switch signal) for reference point approach

Note

The “controller message” input is configured as an isolated optical coupler input. This allows both a current-sourcing and a current-sinking output of the power section to be connected. For details about wiring see Section 4.5.

Table 4-7 Electrical parameters, "Ready message" input

Parameters	Value	Unit	Comment
1 signal, voltage range	15 – 30	V	
1 signal, power consumption	2 – 6	mA	
0 signal, voltage range	-3 – 5	V	or input open
Signal delay 0 → 1	30	μs	
Signal delay 1 → 0	150	μs	
Internal signal delay	20	μs	for actual value transfer function

There are two ways of powering the standby signal:

- from the open-loop control
- from the drive unit

Power from the open-loop control

Figure 4-7 shows examples of how to power the standby signal from the control.

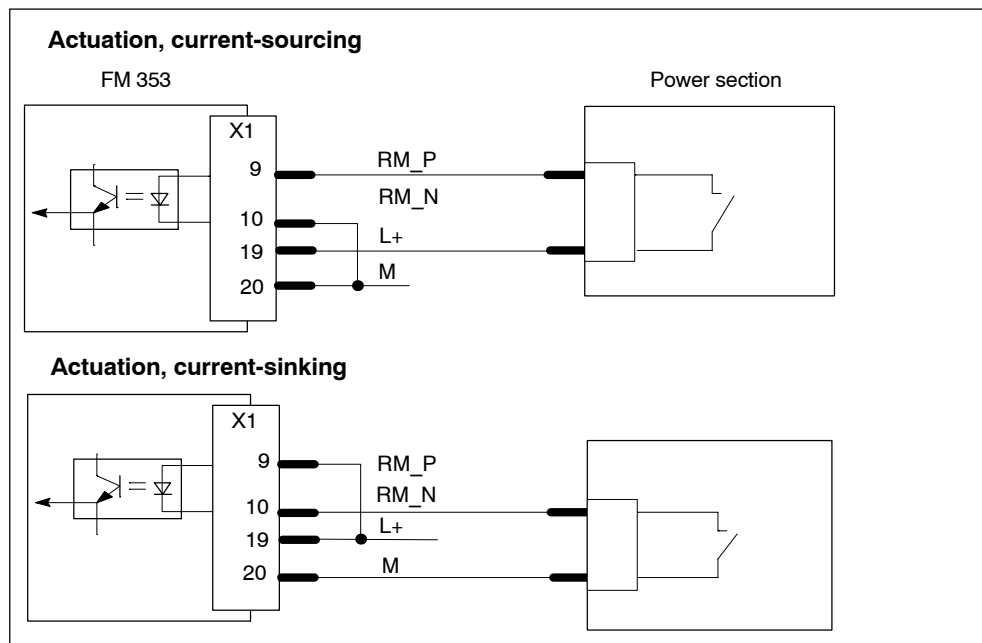

Fig. 4-7 Actuation of the input controller message, power supply from the control

Power from the drive unit

Figure 4-8 shows examples of how to power the standby signal from the drive unit.

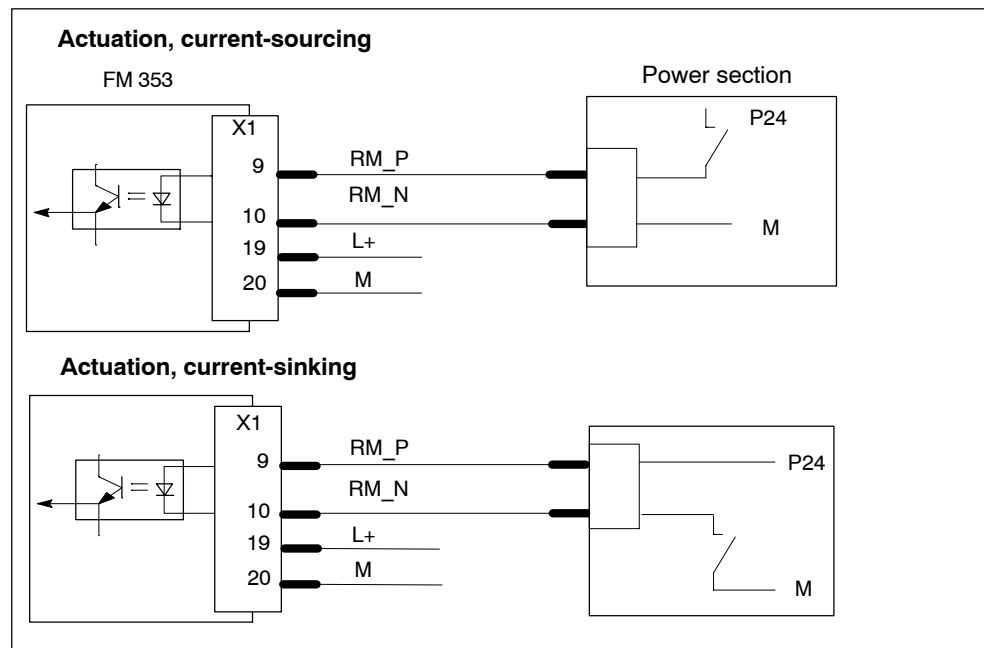

Fig. 4-8 Actuation of the input controller message, power supply from the drive unit

4 digital outputs (DQ1...4)

All outputs have equal priority. The switching function is allocated to the output number in machine data (see MD34, 35, Section 5.3.1).

These four outputs are intended for wiring of application-specific signals.

Possible uses include:

- Position reached and stopped
- Switching function M command
- Forward/backward rotation

See Section 5.3.1 for further applications.

Note

Make sure that the cable length between the digital outputs and the load does not exceed a permissible max. length of 30 m.

Table 4-8 Electrical parameters of digital outputs

Supply voltage	24 V DC (allowable range: 20.4 – 28.8 V)
Electrical isolation	No
Output voltage	<ul style="list-style-type: none"> • 0 signal: Residual current max. 2 mA • 1 signal: (Power supply –3 V)
Output current on signal "1"	<ul style="list-style-type: none"> • at ambient temperature of 40°C <ul style="list-style-type: none"> – Rated value 0.5 A (total current 2 A) – Permissible value range 5 mA...0.6 A (over power supply range) – Lamp load max. 5 W • at ambient temperature of 60°C <ul style="list-style-type: none"> – Rated value 0.1 A (total current 0.4 A) – Permissible value range 5 mA...0.12 A (over power supply)
Switching rate	<ul style="list-style-type: none"> • Resistive load: max. 100 Hz • Inductive load: 0.25 Hz

Load power supply (L+, M)

Here a 24-V load power supply must be connected. The unit will not operate if the poles are reversed.

Note

Note the SIMATIC setup guidelines. In particular, the M terminal (reference potential) must be connected with the chassis ground of the programmable controller (M terminal on the terminal block of the S7-300 CPU).

see manual *S7-300 Programmable Controller, Hardware and Installation*.



Danger

The 24 V load power supply should be a functional extra-low voltage with safe isolation to EN60204-1, Section 6.4, PELV (with M grounding).

Note

Make sure that the interconnecting cable between power supply and load power supply connection L+ and appropriate reference potential M does **not** exceed a max. permissible length of 10 m.

4.5 Wiring up the front connector

Wiring up the front connector

Figure 4-9 shows how to lay the lines to the front connector, and how to relieve strain on the lines with the terminal element.

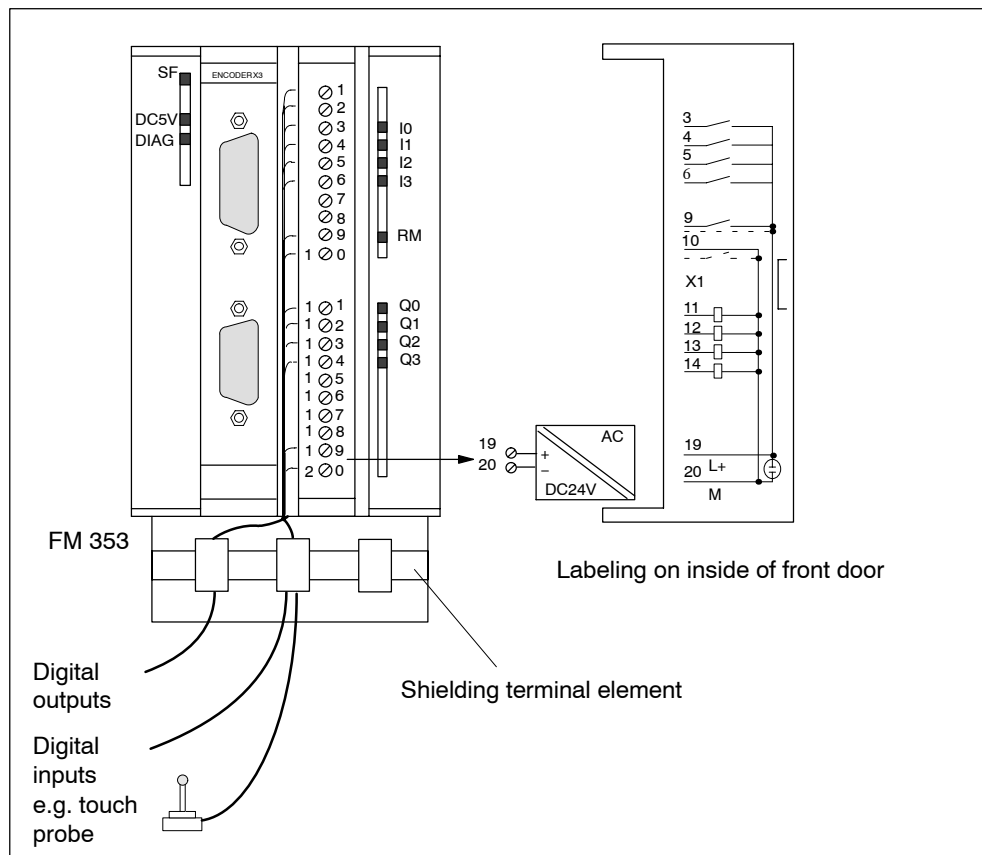

Fig. 4-9 Wiring of the front connector

Connecting cables

Flexible conductor, cross-sectional area 0.25...1.5 mm²

Ferrules are not necessary.

You can use ferrules without insulating collars per DIN 46228, Shape A, long configuration.

You can connect two lines measuring 0.25 – 0.75 mm² in a single ferrule.

Note

To provide optimum immunity to interference, shielded cables should be used to connect touch probes or sensors.

Tools required

A 3.5 mm (.13 inches) screwdriver or power screwdriver.

Procedure for wiring the front connector

To wire the terminal strip:

1. Strip 6 mm (.23 inches) of insulation from the cable; apply ferrules, if any.
2. Open the front door. Move the front connector into position for wiring (while pressing down on the locking elements as shown in Figure 4-6).
Lock the connector in place without any electrical contact to the module.
3. Apply the cable grip to the connector.
4. If you are leading the lines out from below, start wiring from the bottom; otherwise start from the top. Screw down unused terminals as well.

The tightening torque should be 60-80 Nm.

5. Tighten the cable grip on the cable strand.
6. Move the front connector into operating position (while pressing down on the locking elements).
7. You can fill out the labeling strip enclosed with the product and slip it into the front panel.

Shielded cables

When using shielded cables, the following additional steps are necessary:

1. After leading the cable into the cabinet, connect the cable shielding with a grounded shielding bus (strip the insulation from the cable itself).

For this you can use the shielding terminal element mounted on the DIN rail; it will accept up to eight shielding terminals.

see manual *S7-300 Programmable Controller, Hardware and Installation*.

2. Connect the shielded line to the module, but do not connect the shielding there.

Shielding terminal element

To provide a shielding end lead for shielded cables, this element can be inserted in the DIN rail. It can accept up to eight shielding terminals (KLBÜ line from Weidmüller).

Order No.: Terminal element: 6ES7 390-5AA00-0AA0
 Shielding terminal: 6ES7 390-5CA00-7AA0

see *Catalog NC 60.1*, Order No. E86060-K4460-A101-A□

see *Catalog ST 70*, Order No. E86060-K4670-A101-A□



Defining Parameters

5

Chapter Overview

Section	Section Header	Page
5.1	Installing "Parameterize FM 353"	5-3
5.2	Getting started with "Parameterize FM 353"	5-4
5.3	Parameter data	5-7
5.4	Parameterization with "Parameterize FM 353"	5-25
5.5	Storing the parameter data in SDB \geq 1 000	5-26

Overview

This chapter gives you an overview of how to define the parameters of the FM 353 with the “Parameterize FM 353” tool.

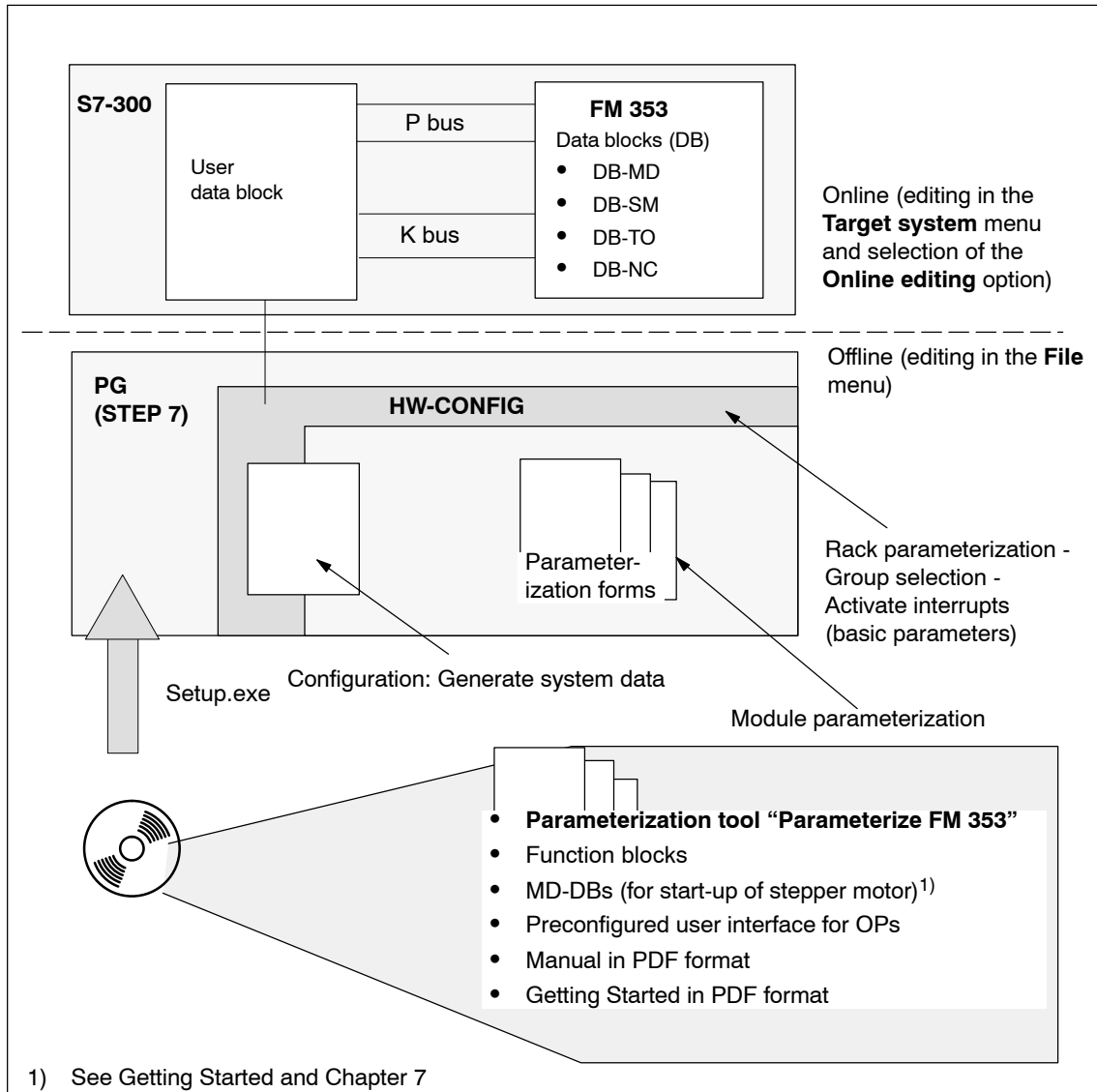

Fig. 5-1 Overview of parameterization

5.1 Installing “Parameterize FM 353”

Prerequisites

One of the following operating systems must be installed on the programming device (PG/PC):

- “Windows Vista 32 Bit Ultimate”
- “Windows Vista 32 Bit Business”
- “Windows 2000 SP4”
- “Windows 2003 Server”
- “Windows XP-Professional”

You need the STEP 7 program (V5.3 + SP2 or higher by Windows Vista: V5.4 + SP3 or higher).

For online operation, make sure that your programming device (PG) / PC is connected to the S7-300 CPU (see Figure 4-1). For distributed use of the FM, a connection from the PG / PC must be established to the L2 DP network. For distributed use of the FM 353 in PROFINET, a connection from the PG / PC must be established to the L2 DP network or to the Ethernet via a switch module.

Installation

The entire software (parameterization tool, function blocks and preconfigured user interface for OPs) is stored on CD ROM.

Install the software as follows:

1. Insert the CD ROM in the CD ROM drive of your PG/PC.
2. Run file **Setup.exe** on the CD ROM.
3. Follow the instructions displayed by the installation routine step for step.

Result: The software is installed in the following directories:

- “Parameterize FM 353” parameterization tool: **[STEP7 directory]\S7FSTEP**
- Technology functions:
[STEP7 directory]\S7LIBS\FMSTSV_L (library name: “FMSTSV_L”)
- Technology functions (also for PROFINET, upon request):
[STEP7 directory]\S7LIBS\FM353_354 (library name: “FM353_354”)
- User interface for OPs:
[STEP7 directory]\EXAMPLES\FM353\zDt13_02_FM353_OP_EX
- Sample applications for blocks of the FMSTSV_L library:
[STEP7 directory]\EXAMPLES\zDt13_02
STEP7 project name: **zDt13_02_FM353_EX**
- Sample applications for blocks of the FM353_354 library:
[STEP7 directory]\EXAMPLES\zDt13_03
STEP7 project name: **zDt13_03_FM353_EX**
- MD DBs (for commissioning of the stepper drive):
[STEP7 directory]\EXAMPLES\FM353\MD

5.2 Getting started with “Parameterize FM 353”

Prerequisites

You have installed the software on your programming device/PC, as described in Section 5.1.

Configuration

Before you can configure your system, you must create a project in which to save the parameters. You will find further information on how to configure modules in your user manual *Standard Software for S7 and M7, STEP 7*. The description below outlines only the most important steps.

1. Start the *SIMATIC Manager* and open your project.
2. Insert a **SIMATIC 300 station** in the menu **Insert > Station**.
3. Select the **SIMATIC 300 station**. Call up the S7 hardware configuration from the menu **Edit > Open Object**.
4. Select a rack.
5. Select the FM 353 positioning module with the correct order number from the module catalog, and insert it in the hardware table as appropriate for your configuration.
6. Double-click a module to configure it.

The **Properties** dialog box appears.

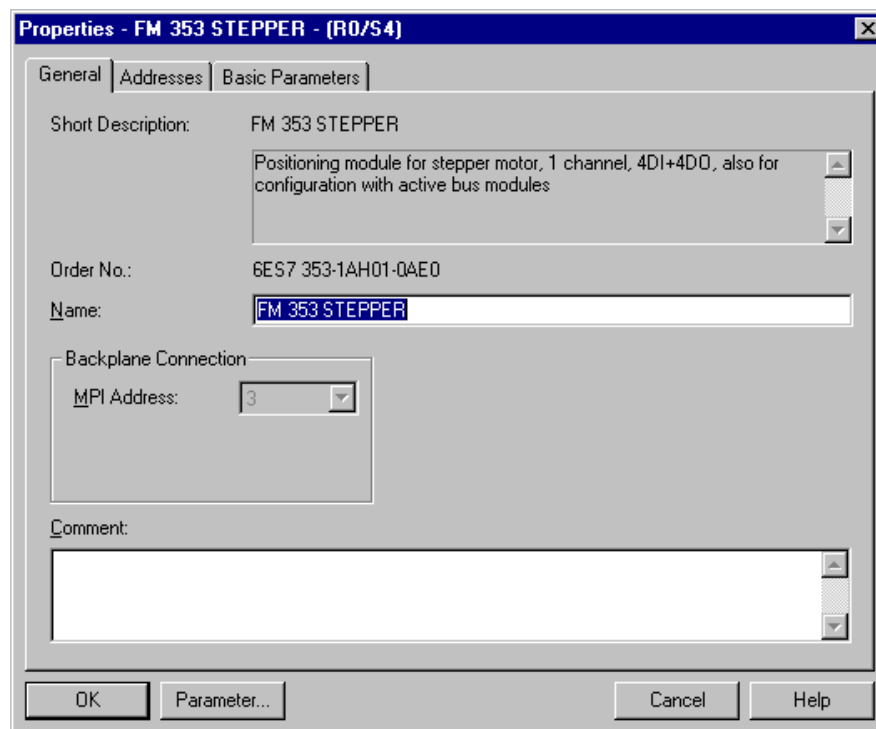

Fig. 5-2 Getting started with “Parameterize FM 353”

7. By clicking on the tabs in this FM 353 window (General, Addresses and Basic Parameters), you can
- Assign a name
 - Change the address of the FM as well as any input parameters for the POS_INIT block (see Section 6.3.2)
 - Configure the interrupts (diagnostic interrupt, process interrupt).

Note:

Further operation of the FM 353 is not possible with the CPU in the STOP state.

Click the **Parameters** button to call up the screen for setting the parameters.

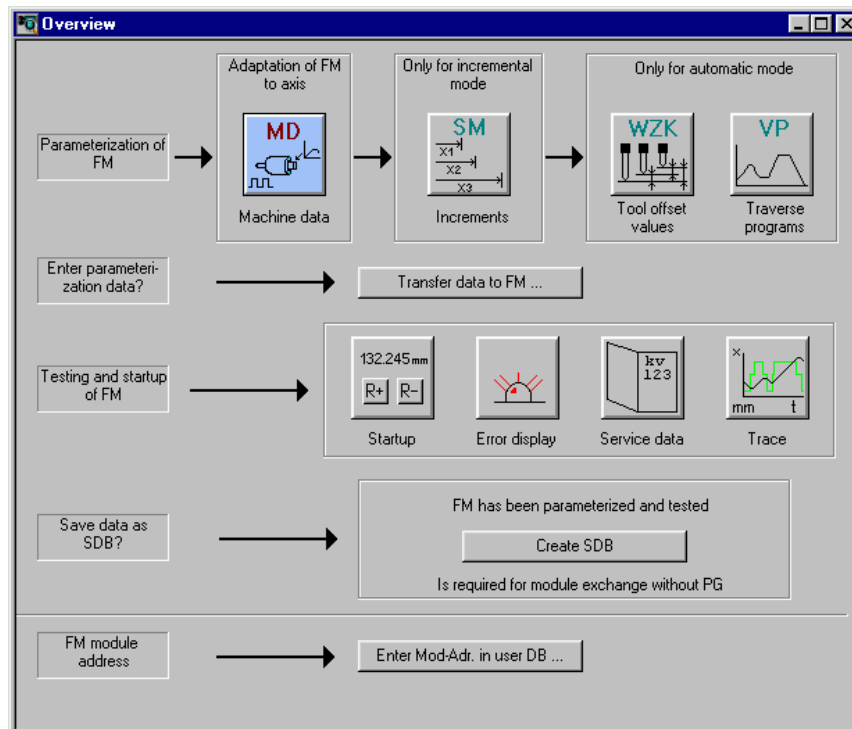

Fig. 5-3 Overview display for parameterization

You can return to this display at any point during parameterization by selecting the menu **View > Overview**.

The FM 353 module for stepper drive-controlled positioning is parameterized by way of parameter DBs that reside in memory on the module. Here a key function is performed by the “Machine data” data block (DB-MD), since it is always needed, regardless of what technological function the module performs. All other parameter DBs are only needed as a function of the technology involved.

You can now set the parameters of your module. This chapter gives you an overview of the parameters that can be set.

You can use the mouse to change the size of the window for entering the parameter data and the size of the overview display.

Proceed as follows:

1. Position the mouse pointer on the top border of the window, so that it changes into an arrow.
2. Press the left mouse button, and drag the pointer downwards by moving the mouse.
3. Release the mouse button.
4. Position the mouse pointer on the bar with the name of the window.
5. Press the left mouse button, and drag the pointer upwards by moving the mouse. When you have moved the window to the correct position, release the mouse button.

When you have configured your project, you can call up the **Properties** screen in S7 Configuration by selecting the module and activating the menu command **Edit > Object Properties**.

Integrated help

The parameterization user interface has an integrated help system to support you when you set the parameters of the positioning module. To call up the integrated help:

- Select the menu command **Help > Help Topics...** or
- press the **F1** key or
- select the symbol  and then move to the element or window you want information about and press the left mouse button.

5.3 Parameter data

What can I parameterize?

You can parameterize the following data storage areas:

- Machine data (MD)
- Increment sizes (SM)
- Tool offset data (TO)
- Traversing programs (NC)
- User data (user data blocks)

This data is stored in data blocks (DBs) within the numerical range 1001 to 1239 (not including user data).

The MD, SM, TO and NC data blocks are transferred to the FM 353 and reside in memory there.

Parameterization of SM, TO and NC may be omitted if the associated functions are not used.

The user data block must be stored in the CPU. Only then can it be filled with data online (see Chapter 6).

Parameterization data (except for user data) can also be created, edited and saved offline on the PG.

Data blocks (DB) of the FM 353

Table 5-1 gives you an overview of the data blocks in the FM 353 and their meaning.

Table 5-1 Data blocks

Data block	Significance
DB-MD	<p>Machine data (DB No. = 1210)</p> <p>User memory requirements = 284 bytes</p> <p>Machine data serves to adapt the FM 353 to the user's own specific application. Parameterization with machine data is essential in order for the FM's functions to be activated. The parameterized DB-MD should be loaded to the FM. As it is written to the FM 353, the DB-MD is checked for the input limits of the individual values and their interdependencies. It is then stored only if all values are allowed. Otherwise data error messages are displayed by way of the MPI. A defective DB will not be retained when the power is turned off.</p> <p>The machine data can then be activated by way of "Activate machine data" or by switching the equipment on and off.</p>

Table 5-1 Data blocks, continued

Data block	Significance
DB-SM	<p>Increments (DB No. = 1230) User memory requirements = 468 bytes</p> <p>Increments serve in the “Relative incremental” operating mode as user-definable relative path distances for individual positioning. You can define from 1 to 100 increment sizes (see Section 5.3.2).</p> <p>Modifications can be made in all operating modes (even in “Incremental relative” mode) during movement. The modifications of the increments must always be complete before a new movement is started in “Incremental relative” mode. If this is not the case, the error message “incremental dimensions do not exist” is output Cl. 2/No. 13.</p>
DB-TO	<p>Tool offset data (DB No. = 1220) User memory requirements = 308 bytes</p> <p>The use of tool length compensation and wear values is described in Section 10.1. Up to 20 compensation or wear values are available.</p> <p>Tool offset data are required for the “Automatic and Automatic single block” modes.</p> <p>Modifications can be made in all operating modes and during movement. If modifications are made during starting or at block transitions when the tool compensation is active (internal access to offset values), the error message “tool offset value does not exist” is output Cl.3/No.35.</p>
DB-NC	<p>Traversing programs (Program No. + 1000 = DB No. = 1001...1199) User memory requirements = 108 + (20 x no. of traversing blocks)</p> <p>Traversing programs are required for the “Automatic and Automatic single block” modes.</p> <ul style="list-style-type: none"> • Programs which are not selected can always be modified. • If modifications are made to a preselected program, including the subprogram, preselection of the program is canceled. You must then select the program again. A modification can be made to a program when BL = 0 (start of program/end of program) and on Stop.
System data block SDB ≥ 1 000	<p>For module replacement without PG</p> <p>All the parameter data of the FM 353 (DB-MD, DB-SM, DB-WK, DB-NC) are stored in SDB ≥ 1 000. This SDB is loaded into the CPU and is used as an additional means of data storage.</p>
DB-SS	<p>Data block for status messages (DB no. 1000)</p> <p>The DB-SS is an internal DB on the FM for testing, start-up and operator control and monitoring.</p>
DB 1249	<p>Internal DB on the FM, not relevant for user.</p>

Data block structure

Table 5-2 gives a rough picture of data block structure.

Table 5-2 Data block structure

Addresses/ Offset	Contents	Comment
	DB header	System information, not relevant for user
0 and above	User data area / structure header	Information for labeling of data block within the system
24 and above for MD, otherwise 32	User data	Parameterization data

Detailed data block structures and parameterization data for the individual types of data blocks can be found in the following sections.

5.3.1 Machine data

DB structure

Table 5-3 gives you an overview of the structure of the “machine data” data block (DB-MD).

Table 5-3 DB structure – machine data

Byte	Variable type	Value	Significance of the variables	Comment
			DB header	
0	WORD		Rack slot	Module address
2	WORD		DB No. (≥ 1000)	As in DB header
4	DWORD		Reserved	
8	WORD		Error No. (from FM)	With MMI services
10	WORD	1	Channel number	
12	2 STRING	MD	DB identifier/type	2 ASCII characters
16	DWORD	353	Module identifier	FM 353
20	4 CHAR	0	Version number/block number	(DB structure)
24 and above. ..			See machine data list MD5 – MD51	

Note: MD address in DB = (MD-Nr. -5) * 4 +24

Entering values

In “Parameterize FM 353” select the menu **File > New > Machine Data** to call up the following display.

Fig. 5-4 Entering values for machine data

Enter the machine data in the tab windows.

You can also enter your values in a table by selecting **View > Table form**.

When creating the MD DBs you must follow the instructions in Chapter 7 “Starting up the FM 353”.

Note

The measurement system (MD7) must match the measurement system specified in the other DBs.

The measurement system raster (MSR) is the smallest distance unit in the active system of measurement.

If at some point you have failed to take this precaution:

1. Delete all data blocks (which do not match the measurement system) or clear the memory of the FM 353 completely.
2. Modify the other data blocks on the PG.
3. Reload the data blocks to the FM 353.

Machine data list

All machine data of the FM 353 are listed in Table 5-4.

Notes to the machine data list:

K are configuration data; see Section 9.3.3

E are settable machine data for alignment (start-up optimization) and technology, see Section 9.3.3

The units of measurement refer to the value representation in the machine data DB.

Table 5-4 Machine data list

No.	Designation	Default values	Value/Meaning	Data type/ Unit/Comments	See Sec.
1 – 4				not assigned	
5 E	Process interrupt generation	0	0 = Position reached 1 = Length measurement completed 3 = Change block on-the-fly 4 = Measurement on-the-fly	BITFIELD32	9.10
6	Axis name	X	max. 2 ASCII characters ¹⁾	4 bytes ³⁾	
7 K	System of measurement	1	1 = 10 ⁻³ mm 2 = 10 ⁻⁴ inch 3 = 10 ⁻⁴ degrees 4 = 10 ⁻² degrees	DWORD [MSR]	9.4
8 K	Axis type	0	0 = linear axis 1 = rotary axis	DWORD	9.5
9 K	Rotary axis end ²⁾	36 · 10 ⁵	0 – 1 000 000 000	DWORD [MSR]	
10				not assigned	
11 K	Travel per motor revolution (division period) ²⁾	10 000	1 – 1 000 000 000	DWORD [MSR] (integer component)	9.6
12 K	Residual path per motor revolution ²⁾	0	0 – 2 ³² –1	DWORD [2 ⁻³² MSR] (fractional component)	
13 K	Increments per motor revolution (division period) ²⁾	2	2 ¹ – 2 ²⁵	DWORD	
14				not assigned	
15				not assigned	
16 K	Reference-point coordinate	0	-1,000,000,000 – +1,000,000,000	DINT [MSR]	9.2.3

MSR = measurement-system grid RPS = reference-point switch

1) The variable axis name is implemented as an axis letter (X, Y, Z, ...) with an address extension (1...9).

Permissible characters: X, Y, Z, A, B, C, U, V, W, Q, E, 1...9 e.g.: “X”, “X1”

2) see Dependencies

3) The axis name is in bytes 3 and 4 (bytes 1 and 2 give the character length specification)

Table 5-4 Machine data list, continued

No.	Designation	Default values	Value/Meaning	Data type/ Unit/Comments	See Sec.
17				not assigned	
18 K	Type of reference-point approach (reference-point approach direction)	0	0 = direction + current-sourcing pattern zero or zero pulse external to right of RPS 1 = direction + current-sourcing pattern zero or zero pulse external to left of RPS 2 = direction - current-sourcing pattern zero or zero pulse external to right of RPS 3 = direction - current-sourcing pattern zero or zero pulse external to left of RPS 4 = direction +, RPS center 5 = direction -, RPS center 8 = direction +, RPS edge 9 = direction -, RPS edge	DWORD Code identifies position for synchronization point with ref. to RPS. Watch for MD37!	9.2.3
19				not assigned	
20				not assigned	
21 E	Software limit switch, beginning ²⁾	-10 ⁹	-1 000 000 000 -- 1 000 000 000	DINT [MSR]	9.7 9.9
22 E	Software limit switch, end ²⁾	10 ⁹	-1 000 000 000 -- 1 000 000 000		
23				FM 353 used internally	
24 thru 26				not assigned	
27 E	Reference-point shift	0	-1,000,000,000 – +1,000,000,000	DINT [MSR]	9.2.3
28 E	Referencing velocity ²⁾	6 · 10 ⁶	10 – 500 000 000	DWORD [MSR/min]	9.2.3
29 E	Reducing velocity ²⁾	3 · 10 ⁶	10 – 500 000 000	DWORD [MSR/min]	9.2.3
30 E	Backlash compensation	0	0 – 1 000 000	DINT [MSR]	9.7
31 E	Directional reference of backlash	0	0 = as in search for reference 1 = positive 2 = negative	DWORD	

MSR = measurement-system grid RPS = reference-point switch

- 1) The variable axis name is implemented as an axis letter (X, Y, Z, ...) with an address extension (1...9).
Permissible characters: X, Y, Z, A, B, C, U, V, W, Q, E, 1...9 e.g.: "X", "X1"
- 2) see Dependencies
- 3) The axis name is in bytes 3 and 4 (bytes 1 and 2 give the character length specification)

Table 5-4 Machine data list, continued

No.	Designation	Default values	Value/Meaning	Data type/ Unit/Comments	See Sec.
32 K	M-function output type	1	during positioning: 1 = time-controlled 2 = acknowledgment-controlled before positioning: 3 = time-controlled 4 = acknowledgment-controlled after positioning: 5 = time-controlled 6 = acknowledgment-controlled	DWORD serial output of up to 3 M functions in NC block	10.3 9.1
33 K	M-function output time	10	1 – 100,000	DWORD [ms] rounded to 2-ms steps	
34 K	Digital inputs ²⁾	0	0 = external start 1 = input for enable 2 = external block change 3 = set actual value on-the-fly 4 = measure 5 = RPS for search for reference 6 = reversing switch for search for reference	BITFIELD32 bit-coded function allocation: Bit No. I/O 0 Bit No. + 8 I/O 1 Bit No. + 16 I/O 2 Bit No. + 24 I/O 3	9.2.3 9.8
35 K	Digital outputs ²⁾	0	0 = Position reached, stop 1 = Axis movement forward 2 = Axis movement reverse 3 = Change M97 4 = Change M98 5 = Enable Start 7 = Direct output	The front edge always activates the function. Independently of MD36!	9.8
36 K	Input adjustment (signal processing inverted)	0	8 = I0 inverted 9 = I1 inverted 10 = I2 inverted 11 = I3 inverted	BITFIELD32	9.8

MSR = measurement-system grid RPS = reference-point switch

- 1) The variable axis name is implemented as an axis letter (X, Y, Z, ...) with an address extension (1...9).
Permissible characters: X, Y, Z, A, B, C, U, V, W, Q, E, 1...9 e.g.: "X", "X1"
- 2) see Dependencies
- 3) The axis name is in bytes 3 and 4 (bytes 1 and 2 give the character length specification)

Table 5-4 Machine data list, continued

No.	Designation	Default values	Value/Meaning	Data type/ Unit/Comments	See Sec.
37 K	Special control signals	1	0 = Servo enable active 2 = Servo ready active 3 = Servo ready inverted 4 = Servo ready via connector X2 (if Bits 24--27 active) 7 = Time override active 8 = Pulse output inverted 9 = Direction output inverted 15 = Continue running after emergency stop (drive enable [AF]) 16 = Boost active 17 = Boost inverted 18 = PWM (pulse width modulation) active 19 = PWM inverted 24 = Current-sourcing pattern zero active 25 = Current-sourcing pattern zero inverted 26 = Zero pulse external active 27 = Zero pulse external inverted	BITFIELD32	9.7 9.1.1
38 K	Number of increments per current-sourcing cycle ²⁾	20	0 – 400	DWORD	
39 E	Start/Stop frequency	1 000	10 – 10,000	DWORD [Hz]	
40 E	Frequency value for acceleration switchover ²⁾	10 000	500 – 75,000 Minimum value: MD39 + 1 Maximum value: MD41 – 1	Please follow the diagram "Working range, frequency generator" (see Figure 5-5)	
41 E	Maximum frequency	50 000	500 – 200,000		
42 E	Acceleration 1 ²⁾	100 000	10 – 10,000,000	DWORD [Hz/sec]	
43 E	Acceleration 2 ²⁾	100 000	10 – MD42, 0 as with MD42	Please follow the diagram "Working range, frequency generator" (see Fig. 5-5)	
44 E	Delay 1 ²⁾	100 000	10 – 10,000,000, 0 = as with MD42		
45 E	Delay 2 ²⁾	100 000	10 – MD44, 0 = as with MD43		
46 E	Minimum idle time between two positioning cycles	2	1 – 10,000	DWORD [ms] rounded to stages of module cycle	
47 E	Minimum traversing time at constant frequency	2			

MSR = measurement-system grid RPS = reference-point switch

- The variable axis name is implemented as an axis letter (X, Y, Z, ...) with an address extension (1...9).
Permissible characters: X, Y, Z, A, B, C, U, V, W, Q, E, 1...9 e.g.: "X", "X1"
- see Dependencies
- The axis name is in bytes 3 and 4 (bytes 1 and 2 give the character length specification)

Table 5-4 Machine data list, continued

No.	Designation	Default values	Value/Meaning	Data type/ Unit/Comments	See Sec.
48 K	Boost duration, absolute	100	1 – 1,000,000		9.7.2
49 K	Boost duration, relative	100	1 – 100	DWORD [%]	9.7.2
50 K	Phase current travel	100			
51 K	Phase current idle	100			
52 E	Speed for backlash compensation	0	0 1 – 100	DWORD [%]	9.7
53 E	Mode for backlash compensation	0	0 = before positioning 1 = during positioning	DWORD	9.7
56 E	Motion profile	0	0 (and > 1) Standard motion profile 1 Optimized motion profile	–	7.3.8

MSR = measurement-system grid RPS = reference-point switch

- 1) The variable axis name is implemented as an axis letter (X, Y, Z, ...) with an address extension (1...9).
Permissible characters: X, Y, Z, A, B, C, U, V, W, Q, E, 1...9 e.g.: "X", "X1"
- 2) see Dependencies
- 3) The axis name is in bytes 3 and 4 (bytes 1 and 2 give the character length specification)

Dependencies

With certain combinations of machine data, restrictions in the value range arise for non-processing of the machine data.

These dependencies are verified on acceptance of the MD DB or individual machine data, and an error message is output in the event of a violation. Some checks are performed on the basis of internally calculated reference variables.

These reference variables and the dependency checks are described in the tables below.

Reference variables generated internally from MD:

Generation of travel per motor revolution **UMWEG**

$UMWEG = MD11 + MD12 \cdot 2^{-32}$

Generation of internal measured value factor **MWFAKTOR**

$MWFAKTOR = UMWEG / MD13$

Activation of software limit switches **SEAKT**

MD21	MD22	SEAKT
$= -10^9$	$= +10^9$	0 (inactive)
$\neq -10^9$	$= +10^9$	1 (active)
$= -10^9$	$\neq +10^9$	
$\neq -10^9$	$\neq +10^9$	

Internal generation of absolute traversing range limits **VFBABS**

MWFAKTOR	VFBABS
< 1	$10^9 / MWFAKTOR$
≥ 1	10^9

Verification:

MD9 check

MD8	MD18	Permissible rotary axis end	
0		any, not relevant	
1	≥ 4		$(MD41 \cdot MWFAKTOR) / 500$ $\leq MD9 \leq VFBABS$
	< 4	$MD9 \bmod UMWEG == 0$	

MD11, MD12, MD13 check → results in MWFAKTOR (see above)

Permissible measured value factor range:	$2^{-14} < MWFAKTOR < 2^{14}$
--	-------------------------------

MD21, MD22 check

SEAKT	MD8	Permissible software limit switches
0	-	MD21 = -10^9 , MD22 = $+10^9$
1	0	MD21 ≥ -VFBABS MD22 ≤ VFBABS MD21 < MD22
	1	0 ≤ MD21 < MD9 0 ≤ MD22 < MD9 MD21 ≠ MD22

MD28 check

Permissible velocity:	$10 \leq MD28 \leq MD41 \cdot MWFAKTOR \cdot 60$
-----------------------	--

MD29 check

Permissible velocity:	$10 \leq MD29 \leq MD41 \cdot MWFAKTOR \cdot 60$
-----------------------	--

MD34 check

Permissible: BYTE0(MD34) ≠ BYTE1(MD34) ≠ BYTE2(MD34) ≠ BYTE3(MD34)
--

MD35 check

Permissible: BYTE0(MD35)&0x7F ≠ BYTE1(MD35)&0x7F ≠ BYTE2(MD35)&0x7F ≠ BYTE3(MD35)&0x7F

MD38 check

MD38	Permissible increment number per current-sourcing cycle
0	
≠ 0	MD38 ≥ 4

MD40 check

Permissible frequency:	$MD39 \leq MD40 \leq MD41$
------------------------	----------------------------

MD41 check

Permissible frequency:	$MD41 \leq VMAX/MWFAKTOR/60$ VMAX = 500 000 000 MSR/min see Section 10.1
------------------------	---

MD42 check

Permissible acceleration:	$MD41 / 200 \leq MD42 \leq MD39^2$
---------------------------	------------------------------------

MD43 check

MD43	Permissible acceleration
0	0
$\neq 0$	$MD41 / 200 \leq MD43 \leq MD39^2$

MD44 check

MD44	Permissible acceleration
0	0
$\neq 0$	$MD41 / 200 \leq MD44 \leq MD39^2$

MD45 check

MD45	Permissible acceleration
0	0
$\neq 0$	$MD41 / 200 \leq MD45 \leq MD39^2$

“Working range of frequency generator”

You can use the following diagram to check that the combination of parameters selected in machine data MD39 to MD45 lie within the working range of the frequency generator (white area).

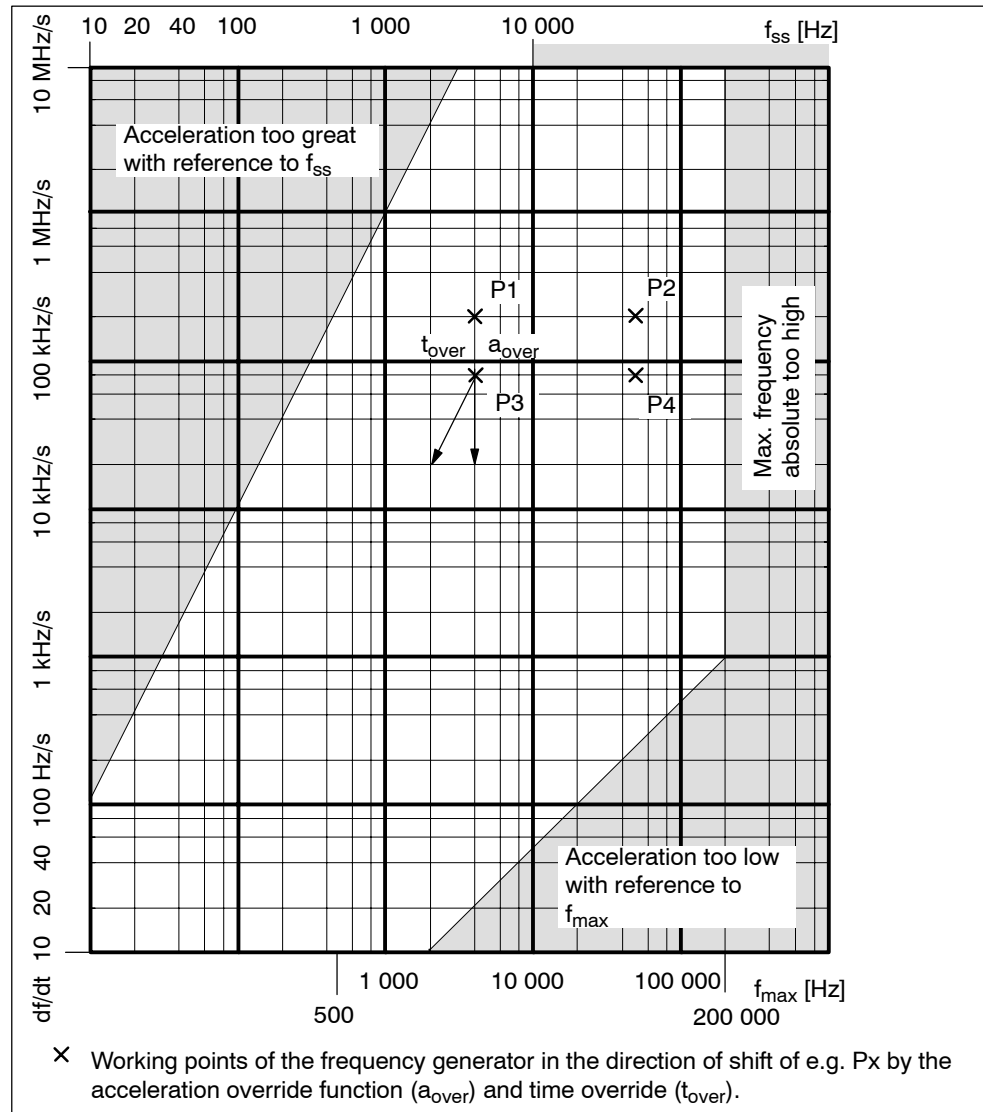

Fig. 5-5 Working range, frequency generator

Machine data values range:

Start/Stop frequency f_{ss} :	(MD39)	10 Hz – 10 kHz
Maximum frequency f_{max} :	(MD41)	500 Hz – 200 kHz
Frequency rise df/dt :	(MD42 – 45)	10 Hz/s – 10 MHz/s

Condition: The intersections of the lines df/dt and $f_{ss}d$ df/dt with f_{max} must be within the white area!

Example: MD39 = 4 kHz, MD41 = 50 kHz
 MD42, 44 = 200 kHz/s → P1/P2
 MD43, 45 = 80 kHz/s → P3/P4

5.3.2 Increments

DB structure

Table 5-5 gives you a general view of the structure of the “Increments” data block (DB-SM).

Table 5-5 DB structure – increments

Byte	Variable type	Value	Significance of the variables	Comment
			DB header	
0	WORD		Rack slot	Module address
2	WORD		DB No. (≥ 1000)	As in DB header
4	DWORD		Reserved	
8	WORD		Error No. (from FM)	With HMI services
10	WORD	1	Channel number	
12	2 STRING	SM	DB identifier/type	2 ASCII characters
16	DWORD	353	Module identifier	FM 353
20	4 CHAR	0	Version number/block number	(DB structure)
24	DWORD	1 – 3	Measurement-system grid per MD7	Unit of measurement
28	WORD	0/1	Parameter (DB) backup	Job via HMI
30	WORD		Reserved	
32	DWORD	$0 - 10^9$	Increment 1	
36	DWORD	$0 - 10^9$	Increment 2 to increment 100	see Section 9.2.4

Input of values

Values are input in the increments menu of the “Parameterize FM 353” parameterization tool.

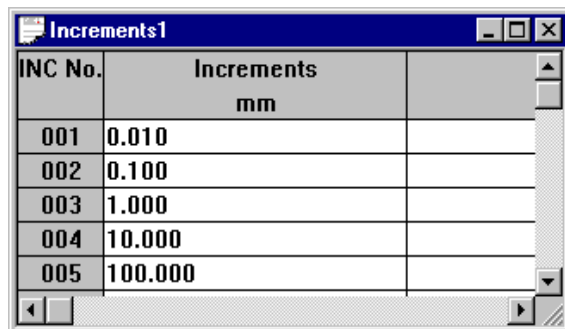

Fig. 5-6 Entering values for incremental dimensions

5.3.3 Tool offset data

DB structure

Table 5-6 gives you a general view of the structure of the “tool offset data” data block (DB-WK).

Table 5-6 DB structure – tool offset data

Byte	Variable type	Value	Significance of the variables	Comment
			DB header	
0	WORD		Rack slot	Module address
2	WORD		DB No. (≥ 1000)	As in DB header
4	DWORD		Reserved	
8	WORD		Error No. (from FM)	With HMI services
10	WORD	1	Channel number	
12	2 STRING	TO	DB identifier/type	2 ASCII characters
16	DWORD	353	Module identifier	FM 353
20	4 CHAR	0	Version number/block number	(DB structure)
24	DWORD	1 – 3	Measurement-system grid per MD7	Unit of measurement
28	WORD	0/1	Parameter (DB) backup	Job via HMI
30	WORD		Reserved	
32	DINT DINT DINT	$-10^9 - 10^9$ $-10^9 - 10^9$ $-10^9 - 10^9$	Tool length offset 1 Wear value 1 absolute Wear value 1 additive	Tool 1
44	DINT DINT DINT	$-10^9 - 10^9$ $-10^9 - 10^9$ $-10^9 - 10^9$	Tool length offset 2 Wear value 2 absolute Wear value 2 additive to Tool length offset 20 Wear value 20 absolute Wear value 20 additive	Tool 2 to Tool 20 see Section 10.1

Input of values

Values are input in the tool offset data menu of the “Parameterize FM 353” parameterization tool.

If the additive wear value is changed online, the FM calculates the new wear parameter as an absolute value and the additive tool wear is reset to 0.

Tool No	Tool length comp. mm	Wear, abs. mm	Wear, add. mm
01	10.000	0.500	0.000
02	20.000	1.500	0.000
03	30.000	2.500	0.000
04	40.000	3.500	0.000
05	50.000	45.000	0.000
06	60.000	55.000	0.000
07	70.000	66.000	0.000
08	80.000	77.000	0.000
09	0.000	0.000	0.000
10	0.000	0.000	0.000
11	0.000	0.000	0.000
12	0.000	0.000	0.000
13	0.000	0.000	0.000
14	0.000	0.000	0.000
15	0.000	0.000	0.000
16	0.000	0.000	0.000
17	0.000	0.000	0.000
18	0.000	0.000	0.000
19	0.000	0.000	0.000
20	0.000	0.000	0.000

Fig. 5-7 Entering values for tool offset data

5.3.4 Traversing programs

DB structure

Table 5-7 gives you a general view of the structure of the “traversing programs” data block (DB-NC).

Table 5-7 DB structure – traversing programs

Byte	Variable type	Value	Significance of the variables	Comment
			DB header	
0	WORD		Rack slot	Module address
2	WORD		DB No. (≥ 1000)	As in DB header
4	DWORD		Reserved	
8	WORD		Error No. (from FM)	With HMI services
10	WORD	1	Channel number	
12	2 STRING	NC	DB identifier/type	2 ASCII characters
16	DWORD	353	Module identifier	FM 353
20	4 CHAR	0	Version number/block number	(DB structure)
24	DWORD	1 – 3	Measurement-system grid per MD7	Unit of measurement
28	WORD		Reserved	
30	WORD		Reserved	
32	18 STRING	ASCII char.	NC program name	max. 18 characters
52	STRUCT	NC block	NC block new (modification range)	
72	STRUCT	NC block	1st traversing block	
92	STRUCT	NC block	2nd to 100th traversing block	see Section 9.3.11, 10.1

Input of traversing programs

An empty window is provided for the input of NC traversing programs. Here you can input your traversing program as follows:

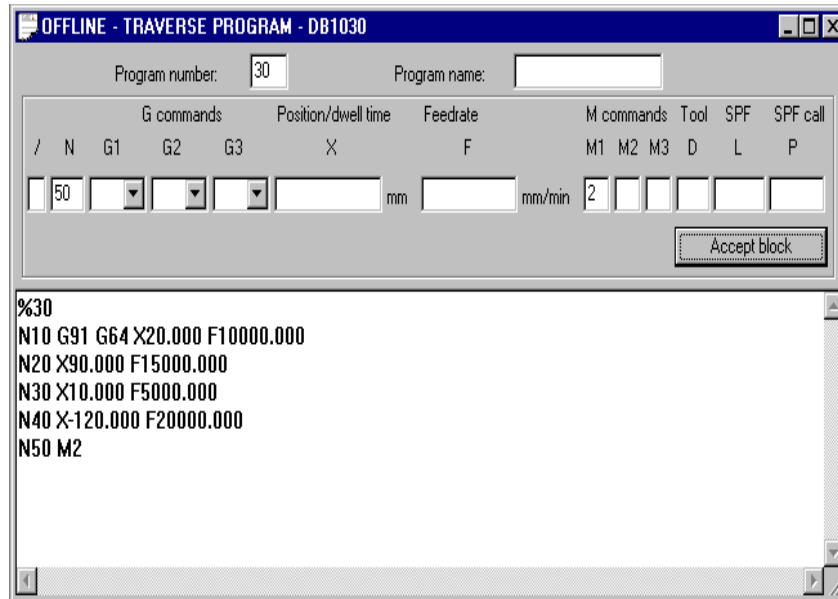

Fig. 5-8 Entry for traversing programs

1. % Program number Program name

The “%” can be input only in the first line. This input is mandatory. The DB number is formed from the program number.

The program name is optional and may have up to 18 characters.

2. N<block number> – G<command> (G1, G2, G3) – X<value> – F<value> – M<command> (M1, M2, M3) – D<No.> (tool offset number) – L<No.> – P<No.> – (for NC programming see Chapter 10).

- You must enter the block number (N) **first and in ascending order**. The rest of the inputs may be in any desired sequence.
- Input separators as a blank.

You must enter characters in upper case letters.

You can also use the input area at the top of the screen. The program number and the program name are saved when you exit the input box. You can save the traversing blocks with the “Save Block” button.

5.4 Parameterization with “Parameterize FM 353”

Entering the values

You have a variety of options for entering your parameterization data.

1. User data

You can input values or select texts in a table. Select input fields with the cursor and enter the values. You can select the associated texts for the values with the space key.

2. Machine data

The values are entered in dialog boxes and windows selected by option tabs.

To display the machine data in a table, select the menu **View > Table form**. Here you can enter the values as described in the user data section.

3. Tool compensation data and increment sizes

You can input the values in a table. Select input fields with the cursor and enter the values.

4. Traversing programs

Traversing programs are input in text format.

A comment column is included in the tables for MD, SM, and TO values. This comment is not stored in the data block. It can be printed out or stored with the data in the file on export.

5.5 Storing the parameter data in SDB \geq 1 000

Overview

The FM 353 stores its parameter data internally.

In order to ensure that the parameter data are available if a fault develops on the FM 353 and no programming device/PC is at hand, the data can be stored in a system data block (SDB \geq 1 000). The CPU transfers the data stored in SDB \geq 1 000 to the FM 353 on each new start. If the FM 353 has no machine data or the internal time stamp (time of creation) is invalid, the data are transferred from SDB \geq 1 000 to the FM 353 and saved there.

The time stamp is renewed every time a DB (parameter data) is opened and when a file is imported. If the contents of the DB are modified (for instance the machine data), a new time stamp is also generated when the DB is saved or loaded.

You must ensure that the parameter data in SDB \geq 1 000 always match the parameter data on the FM 353 when start-up is complete.

Note

If parameter data are modified again in the FM following creation of SDB \geq 1 000, they are overwritten when the CPU is restarted (see "Time stamp", above).

SDB \geq 1 000 should therefore not be created until start-up is finished!

If you need to modify the data subsequently, you should generate SDB \geq 1 000 again and load it into the CPU. You can delete the previous SDB before you load the new one, however the new SDB automatically overwrites the old one when it is generated. The old SDB and the new SDB do not have to be allocated the same number.

Creating the SDB

Prerequisite: Online connection with the FM 353

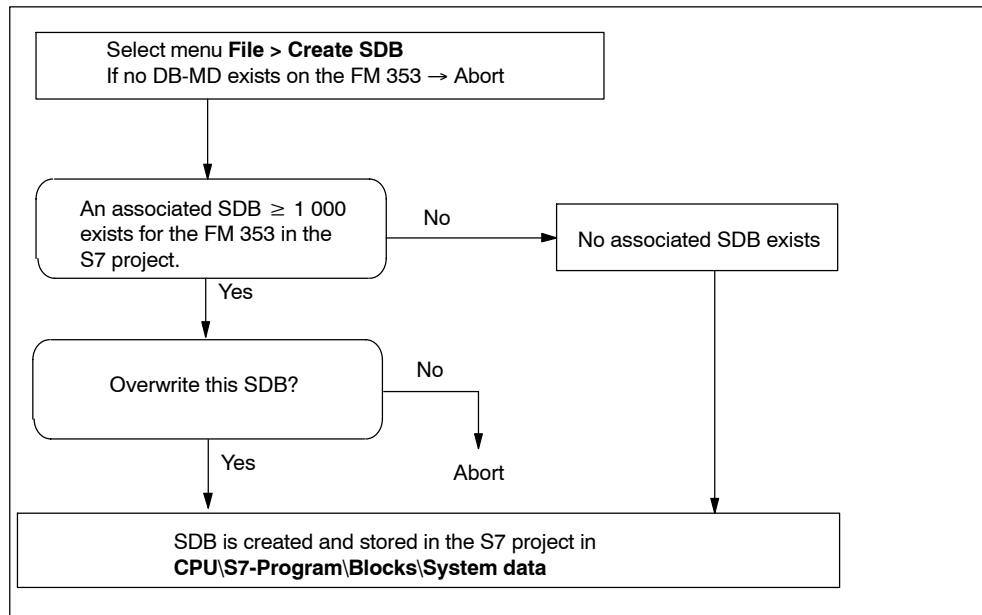

Fig. 5-9 Creating SDB $\geq 1\ 000$

Display/delete SDB in the S7 project

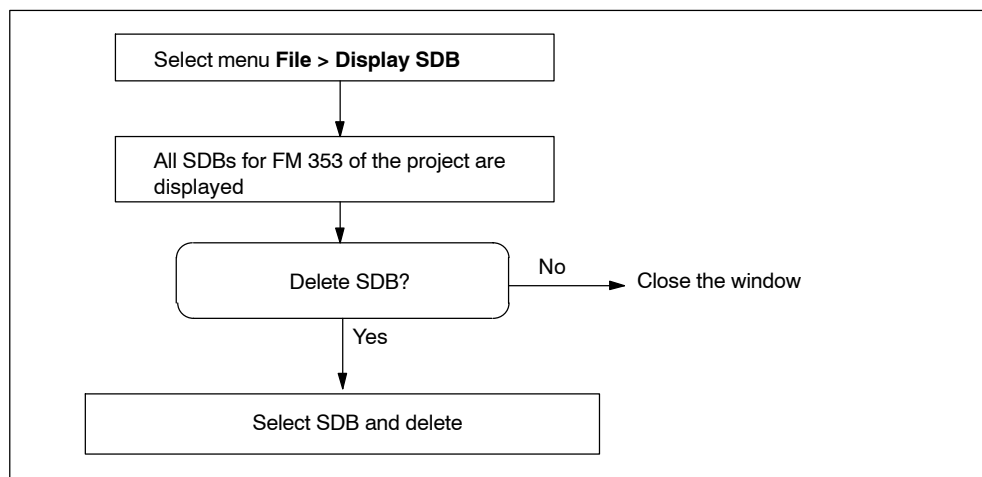

Fig. 5-10 Displaying/deleting SDB $\geq 1\ 000$

Loading the SDB in the CPU

When you have created the SDB, you must load the “system data” of the project into the CPU.

There are two ways of proceeding:

Method 1

Select the online window in the *SIMATIC Manager* (the online and offline windows must be open)

Copy the system data from the offline project in **CPU\S7-Program\Blocks\System data** into the online project (drag with the mouse or select Copy/Paste).

Method 2

Select the system data in the *SIMATIC Manager* in **CPU\S7-Program\Blocks\System data**.

Activate the menu **Target system > Load** (or the right mouse button) to load the system data into the CPU

or

Use the menu **Target system > Load in EPROM memory card on CPU**

You can also program the memory card for the CPU on a programming device/PC.

If the configuration is loaded from HW-CONFIG, this SDB is **not** loaded into the CPU.

Deleting SDBs in the CPU

To delete the SDBs in the CPU:

1. Select “Parameterize FM 353”.
2. Select menu **File > Display SDB**. Delete the SDB(s).
3. Close “Parameterize FM 353” and in the *SIMATIC Manager* in Online Project **select CPU\S7-Program\Blocks\System data**. Delete the system data.
4. Transfer the system data to the CPU again (see above)



Programming the Technological Functions

6

Chapter Overview

Section	Section Header	Page
6.1	Programming fundamentals	6-4
6.2	Putting the FM 353 into operation with the parameter initialization tool	6-8
6.3	Standard function blocks of the "FMSTSV_L" block library	6-8
6.4	Standard function blocks of the "FM353_354" block library (also for PROFINET, upon request)	6-28
6.5	Interrupts	6-44
6.6	User data block (AW-DB)	6-46
6.7	Example applications	6-57
6.8	Error list, system messages (CPU)	6-64
6.9	Technical specifications	6-66

General remarks

The purpose of the function description of the blocks and of the interface is to illustrate the communication between the CPU and the FM 353 in the SIMATIC S7 programmable controller. The programmable blocks and the AW-DB (which is the interface to the FM 353) make it possible for you to write your user program to suit your particular application.

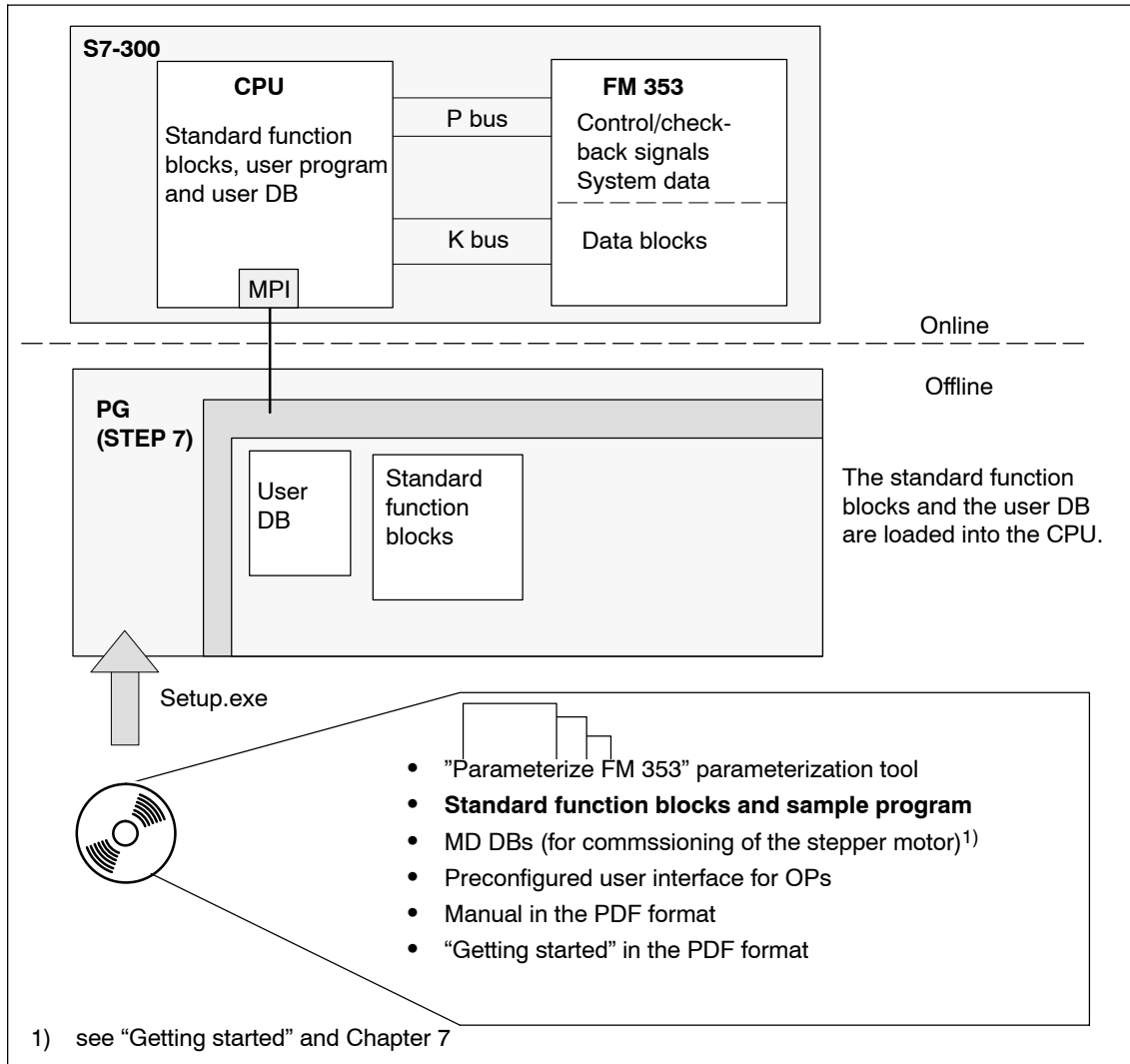

Fig. 6-1 Programming overview

Prerequisites

The following prerequisites must be fulfilled for the development of your user program if you want to control the FM 353:

- You must have installed the software on the PG/PC as per Section 5.1.

The block libraries containing the basic functions are stored in the following directories by default:

- Blocks of the “FMSTSV_L” library:
[STEP7 directory]\S7LIBS\FMSTSV_L
- Blocks of the “FM353_354” library (also for PROFINET, upon request):
[STEP7 directory]\S7LIBS\FM353_354
- The link from PG/PC to the S7 CPU must be established (see Figure 4-1).
- You must have already created your project for the SIMATIC S7 (see “FM 353, First Steps”).

6.1 Programming fundamentals

Overview

In this chapter you will find information on the following:

- Communication between the CPU and the FM 353, Section 6.1.1, p. 6-4
- Structure of a user program, Section 6.1.2, p. 6-5
- Distributed use of OB 86, Section 6.1.3, p. 6-6
- Embedding an OP, Section 6.1.4, p. 6-6
- Procedure for creating a user program, Section 6.1.5, p. 6-7

6.1.1 Communication between the CPU and the FM 353

Embedding the FM 353 in the user program

The diagram below shows you how the FM 353, the user DB and the technological functions communicate.

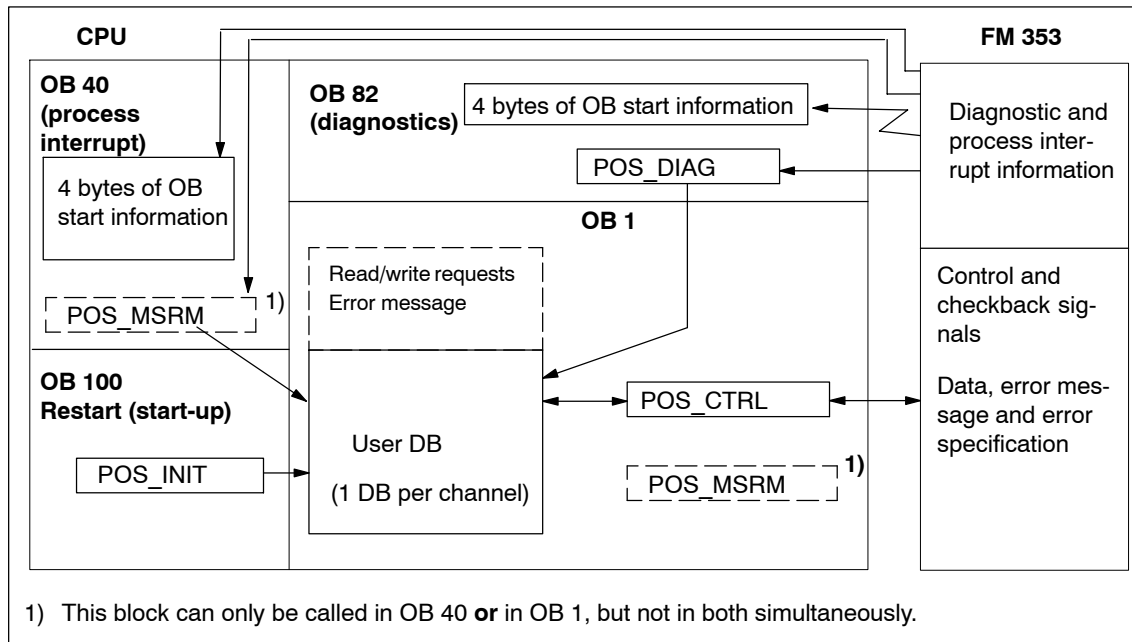
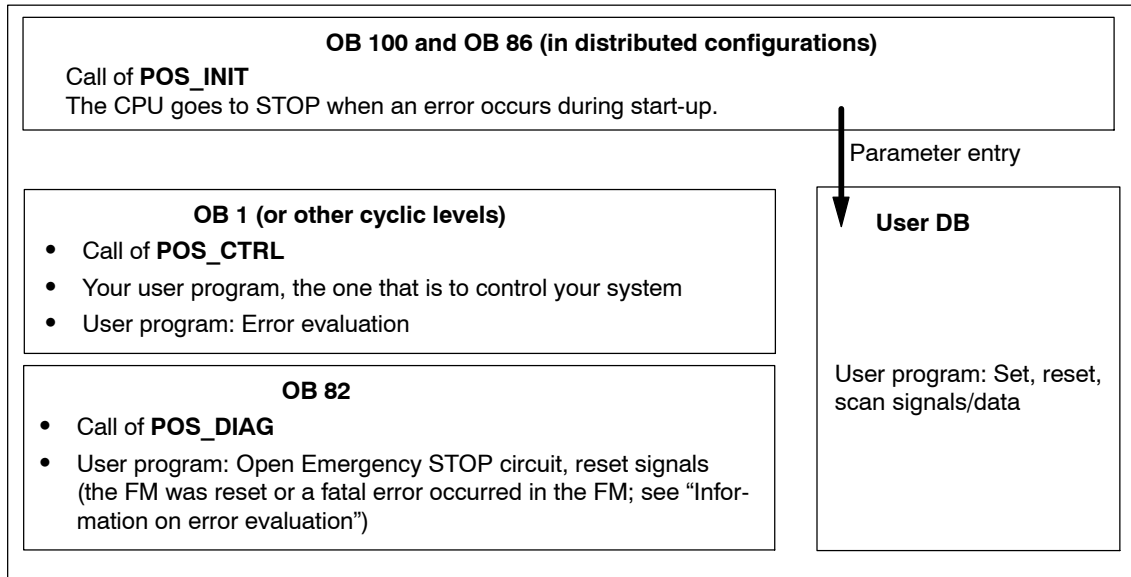

Fig. 6-2 Overview diagram for linking the FM 353 into the user program

6.1.2 Structure of a user program

The diagram below provides an overview of the structure of the user program (AWP).



Note

GET/PUT functions (SFC 72/73) from/to the FM are not guaranteed to work properly, that is to say, these functions are not supported, since they are not required. Parameter initialization data can be modified via the "Modify parameters/data" signal (user DB, DBX39.3).

Information on signal processing:

The FM 353's cycle (= 2 ms) and the user cycle (OB 1) are asynchronous to one another. Depending on the instant of signal transfer to the FM 353, the time it takes to process signals may be = 1 to < 2 x the FM cycle. This must be taken into account particularly when user cycles are short. If necessary, the processing status of the FM 353 should be queried before activating a new action.

Please note that signal/data transmission takes longer/several user cycles in distributed configurations (see Section 6.9).

Information on testing the user program

When testing the user program with “Set breakpoint”, please note that it is not always possible to resume the program scan with the FM 353 after the breakpoint has been reached (for technical reasons).

For example, movements activated by the user program cannot be halted when the user program has reached the breakpoint.

The program can be resumed by executing a restart (CPU: STOP/RUN), by resetting the axis, or by changing the operating mode.

6.1.3 Distributed configuration, OB 86

If system operation must be maintained with an FM 353 despite a faulty link between CPU and distributed I/Os (DP), OB 86 is to be linked into the user program. In OB 86, provisions (e.g. set flag and evaluate in OB) must be made to prevent OB 1 communication with the FM 353 in case of a failure. To enable synchronization of the user program and the FM, the POS_INIT block (corresponding to execution in OB 100) is to be linked on re-establishing the link. Additionally, OB 122 (I/O access error) must be loaded in the CPU.

6.1.4 Embedding an OP

Part of the AW-DB, namely the “Data field for operator control/monitoring” (DBB496 to DBB515), is used to store signals/data for an OP as per the preconfigured operator interface. In order to initiate actions, the relevant signals/data have to be transferred to the interface (relevant area in the AW-DB) via the user program (see Section 6.7, example 4).

6.1.5 Procedure for writing the user program (AWP)

The sample projects “zDt13_02_FM353_EX” included in the configuring package (for the blocks of the “FMSTSV_L” library) and “zDt13_03_FM353_EX” (for blocks of the “FM353_354” library) will help you when creating your user program and can be used as a template.

Suggested procedure:

1. Open your project in the SIMATIC Manager.
2. Select **SIMATIC xxx > CPUxxx > S7 Program**.
3. In the SIMATIC Manager, select **File > Open > Projects** to load the “zDt13_02_FM353_EX” or the “zDt13_03_FM353_EX” project.
4. Select the “EXAMPLES” directory.
5. Select the “Symbols” file and copy it to your project under **SIMATIC xxx > CPUxxx > S7 Program** (replacing the existing object).
6. Open the “Sources” directory and copy from all STL sources to your project’s “Sources” directory.
7. Open the “Blocks” directory and copy all blocks from it into the “Blocks” directory of your project.
8. Select the “Sources” directory in your project. Start the “LAD/STL/FBD Editor” by double-clicking on the “OB_EXAMPLE” file.
9. **Modify the appropriate input parameters (see “Block description”, Sections 6.3 and 6.4) in the POS_INIT call in OB 100 and in the POS_DIAG call in OB 82.**
10. **You can insert the relevant functions from the sample project “zDt13_02_FM353_EX” (see Section 6.7) in the “EXAMPLE CALLS” network in OB 1. The functions can be activated by writing your user program to set/reset the signals in the DB 100 (user DB for the examples) supplied. The call for the POS_CTRL must be modified accordingly (input parameters or appropriate instance DB).**
11. The organization blocks (OB 1, OB 82, OB 100) are generated from the STL source with the menu commands **File > Save** and **File > Compile** (warnings from the compilation run can be ignored).
12. Close the editor.
13. Set the CPU to “STOP” and switch the CPU on.
14. In the SIMATIC Manager, select **SIMATIC xxx > CPUxxx > S7 Program > Blocks**.
15. Load all the S7 blocks (including system data) into your CPU (with the CPU at STOP) with **PLC > Load**.

6.2 Putting the FM 353 into operation with the parameter initialization tool

To put the FM 353 into operation with the parameter initialization tool “Parameterize FM 353”, the CPU must be at “STOP”. It can also be at “RUN”, for example if you want to automate part of your plant or connect the drives, in which case the control/checkback signals “Switch P bus interface to start-up” (AW-DB, DBX14.1) and “Switching of P bus interface concluded” (AW-DB, DBX22.1) must be observed. For a description of these signals, see Section 9.1).

Also please observe Section 7.3 “Testing and Optimization”.

Note

Observe the relevant safety measures if you want to move the axis.

6.3 Standard function blocks of the “FMSTSV_L” block library

Overview

This chapter contains information on the following:

- Overview of the “FMSTSV_L” block library, Section 6.3.1, p. 6-9
- POS_INIT (FC 0) – Initializing the user DB, Section 6.3.2, p. 6-10
- POS_CTRL (FC 1) – Data exchange, Section 6.3.3, p. 6-12
- POS_DIAG (FC 2) – Reading diagnostic alarm data, Section 6.3.4, p. 6-22
- POS_MSRM (FC 3) – Reading measurement values, Sections 6.3.5, p. 6-25
- Interface, user data blocks (AW-DB), Section 6.3.6, p. 6-26

6.3.1 Overview of the “FMSTSV_L” function block library

You can use the blocks of the “FMSTSV_L” block library as follows:

- Central configuration of the FM
- Distributed configuration of the FM via PROFIBUS DP

The table below provides an overview of the functions (FC), data blocks (DB) and organization blocks (OB) required for communication and control of the FM 353.

Table 6-1 Standard function blocks of the “FMSTSV_L” library (overview)

Block	Block Name	Description/Function	Remarks
FC 0 Page 6-10	POS_INIT	Call in OB 100 and OB 83, start-up/initialization	Required for application, no. can be changed ¹⁾
FC 1 Page 6-12	POS_CTRL	Call in OB 1, cyclic operation (synchronization with FM 353) Basic functions and operating modes, interface processing, read and write requests	
FC 2 Page 6-22	POS_DIAG	Call in OB 82, internal errors, external errors, and external channel errors of the FM	
FC 3 Page 6-25	POS_MSRLM	Call in OB 40 or OB 1, reading out of the measured values	To be used only if the function in question is required for the application in question; the number can be changed ¹⁾
DB (UDT)	AW-DB	Interface to the FM	Required for application
OB 1	–	Cyclic level	Required for application
OB 82	–	Diagnostic interrupt level	
OB 100	–	Start-up level	
OB 86	–	Rack failure	For distributed configurations
OB 122	–	I/O access error	

- 1) – **The block number is a default setting**, block number can be changed in the SIMATIC Manager
 – Symbol table entries can be changed in conjunction with symbolic programming only

Note

The symbolic block identifier is used from here on.

6.3.2 The POS_INIT (FC 0) block – Initialization

Function

Use the POS_INIT block to initialize specific areas of your AW-DB.

Call options

The POS_INIT block must be called once in the start-up OB 100 and in OB 86 for "distributed configuration".

Call in LAD representation (ladder diagram)	Call in STL representation (statement list)
	<pre>CALL POS_INIT DB_NO := CH_NO := LADDR :=</pre>

Parameters

The Table below lists the parameters for this block.

Name	Data Type	Param. Type	Description
DB_NO	INT	I	Data block number
CH_NO	BYTE	I	Number of the axis: <ul style="list-style-type: none"> 0 – Only one channel/axis on the module 1 – First channel/axis on the module 2...255 – Illegal } Same meaning internally
LADDR	INT	I	<ul style="list-style-type: none"> • Logical base address of the module; use entry from "HW-CONFIG", → "Properties", → "Address" (see Section 5.2) • 0 – No entry of addresses in the user DB

Parameter types: I = input parameter

Function description

The POS_INIT block carries out the following actions:

1. Entry of addressing values in user DB AW-DB, If parameter LADDR \neq 0
Module address
2. Deletion of the following structures in user DB AW-DB:
 - Control signals
 - Checkback signals
 - Initiate, Ready and Error signals for the job requests
 - Single functions and single commands and their Ready and Error signals
3. If the input parameter LADDR = 0, no address is entered in the user DB. It is assumed that the addressing values (module address) have been entered manually via "Parameterize FM 353" (button "Enter Mod-Adr in user DB" in main display).

Error evaluation

An error is signalled by the binary result BR = 0 or by RET_VAL < 0.

Possible errors are:

- Unknown channel number CH_NO and DB no. = 0 as input parameters; the AW-DB is not initialized.
- If no AW-DB is found, the CPU goes to STOP; view the CPU's diagnostic buffer.

RET_VAL	Error
-1	Unknown channel number
-2	DB number = 0

6.3.3 The POS_CTRL (FC 1) block – Data exchange

Function

The POS_CTRL block is the basic block for controlling the FM 353.

With the POS_CTRL block, you can:

- process read and write requests
- control the operation modes (control and checkback signals)

The POS_CTRL block performs the following actions:

1. Synchronization with the module (only then is the exchange of signals/data possible).
2. Reading of the checkback signals. The values/signals read by the POS_CTRL block are stored in the user data block AW-DB.
3. Transfer of the control signals from user data block AW-DB to the FM 353.
4. Carrying out of Write requests from user data block AW-DB, which includes the transfer of associated data from AW-DB and setting of the job status for the Write. Before the function is activated, all data required for the execution of the intended functions must be entered in AW-DB.
5. Carrying out of Read requests from user data block AW-DB, which includes transfer of the associated data to AW-DB and setting of the Read job status.
6. Automatic transfer of all single functions from user data block AW-DB to the FM 353 when one or more than one setting has been changed and setting of the Write job status (Set or Reset).
7. Automatic transfer of all single commands from user data block AW-DB to the FM 353 and setting of the Write job status. The single commands are reset following the transfer.
8. Automatic reading of the error number when an operator input error, traversing error or data error has occurred. The error number is entered in user data block AW-DB (DBB90 to DBB97) and the Read job status set.

Call options

POS_CTRL must be called cyclically (once in the OB 1 cycle, for instance) for each channel. Before calling the function, enter all data/signals required to execute the intended functions in user data block AW-DB.

Call in LAD Representation (ladder diagram)	Call in STL Representation (statement list)
	<pre>CALL POS_CTRL DB_NO := RET_VAL :=</pre>

Parameters

The Table below lists the parameters for this block.

Name	Data Type	Param. Type	Description
DB_NO	INT	I	Data block number
RET_VAL	INT	Q	Return value

Parameter types: I = input parameter, Q = output parameter

Return values

The function returns the following values:

RET_VAL	BR	Description
1	1	At least 1 job/transfer in progress
0	1	No job/transfer in progress, no error
< 0	0	Error: <ul style="list-style-type: none"> • Data error (AW-DB, DBX22.4) • Communication error (AW-DB, DBW66)

Function description

The function works together with an AW-DB user data block. The DB number is passed to the function in the DB_NO parameter when the block is called.

- **Start-up**

POS_CTRL acknowledges start-up of the module. During this time, the "RET_VAL" parameter and the "Write/Read job in progress" signals (AW-DB, DBX68.0 and DBX68.2) are TRUE.

- **Control and checkback signals**

When POS_CTRL is called, the checkback signals are read from the FM 353 immediately (via direct access). Since the control signals and job requests are processed after these signals have been read, the checkback signals reflect the status of the module before the block was called. The control signals are also written to the FM 353 using direct access.

Depending on the chosen mode, the control signals "Start, "Negative direction" and "Positive direction" (AW-DB, DBX15.0, 15.2 and 15.3) are reset once start-up has actually taken place (edge formation of the signals for the FM).

For information on the generation of the checkback signals "Process" (AW-DB, DBX13.6) and "Position" (AW-DB, DBX13.7), see "Mode control".

- **Job requests**

Data interchange with the module that goes beyond control and checkback signals is handled using job requests. Simultaneously pending Write or Read requests, however, can only be executed in succession, whereby one Read and one Write request are processed in one call.

To issue a request, set the relevant initiation signal in user data block AW-DB (DBB38 to DBB43). In the case of Write requests, you must also make the appropriate data available.

The request is serviced when POS_CTRL is called. When the FM is used centralized, a Read request is performed during the call. A Write request requires at least three calls (or OB cycles) due to the acknowledgements required from the module. The time interval between the calls should exceed the length of one FM cycle.

When a request has been serviced, the Initiate signal is removed (does not apply to single functions).

The next job request is not determined or executed until the next block call has been made.

For each job request, there is a Ready signal (AW-DB, DBX44.0 to 53.7) and an Error signal (AW-DB, DBX54.0 to 63.7) in addition to the Initiate signal.

You should reset the Ready and Error signals for a job request following evaluation or prior to issuing the request.

- **Order in which job requests are serviced/priority**

You may submit several job requests simultaneously, even together with Write requests for single commands and single functions.

As soon as a Write request is detected (also on a signal change in the case of single functions), it is serviced immediately upon completion of the transfer currently in progress, if any. Be sure that signals for single commands are not set cyclically, as this could prevent other job requests from being serviced (priority).

Order/priority of Write requests:

1. Write single commands
2. Write single functions
3. Write requests.

The Write requests are serviced in the order of the Initiate signals, which is stipulated in user data block AW-DB (from DBX38.0 to 39.7).

Order/priority of Read requests:

1. Read error code, operator/traverse errors or data errors
2. Read requests

The Read requests are serviced in the order of the Initiate signals, which is stipulated in user data block AW-DB (from DBX42.0 to 43.6).

• **Job request status**

You can read the status of the job request in return value RET_VAL and in the “Write/read job in progress” signals in user data block AW-DB (DBX68.0 and DBX68.2). You can evaluate the status of an individual job request by evaluating the Initiate, Ready and Error signals for that job request.

Table 6-2 Job request status

Job Request Status	RET_VAL (integer)	Jobs in Progress (DBX68.0 DBX68.2)	Initiate Signals (DBB34...43)	Ready Signals (DBB44...53)	Error Signals (DBB54...63)
1. Job in progress	1	1	1	–	–
2. Job terminated without error	0	–	–	1	–
3. Write job terminated with error in this job	–1	–	–	1	1
4. Write job aborted or not executed	–1	–	–	–	1
5. Read job aborted	–2	–	–	–	1
6. Write and Read aborted or not executed (in the case of simultaneous job requests)	–3	–	–	–	1

– Irrelevant for error evaluation

Processing status

Signal	Description
Write not possible (AW-DB, DBX68.1)	= TRUE; Write request cannot be serviced in this cycle because: <ul style="list-style-type: none"> • The axis is not initialized • Test mode is enabled • No operating mode is active • The selected operating mode has not yet been set In these cases, you can leave the Write request pending or you can cancel it. The POS_CTRL block resets the signal when all of the above-listed conditions are fulfilled.
Read not possible (AW-DB, DBX68.3)	= TRUE; Read request cannot be serviced at this time because: <ul style="list-style-type: none"> • The axis is not initialized • No mode has been selected • Test mode is enabled In these cases, you can leave the Read request pending or you can cancel it. The POS_CTRL block resets the signal when all of the above-listed conditions are fulfilled.
Reset status/error (AW-DB, DBX69.1)	With this signal you can reset all Ready and Error signals prior to processing of the pending job requests. The signal itself is then reset by the block.

Error evaluation

Communication errors or data interpretation errors on the FM are flagged in the Binary Result (BR = 0) and by RET_VAL < 0; see job request status.

Possible errors are:

- Data transfer error (communication is not completed) during a transfer with SFC 58/59 "WR_REC / RD_REC". The error code is made available in user data block AW-DB, DBW66 (RET_VAL value of these internal SFCs) (job states 4, 5 and 6, see Table 6-2, see also Error List, Section 6.8).
- Data transferred with Write are checked for data errors by the module and interpreted. If a data error occurs, the checkback signal "Data error" (AW-DB, DBX22.4) is set to TRUE in user data block AW-DB (message: "Write job terminated with error"). The error number, read out via an internal job request, is entered in user data block AW-DB, DBB94 and 95 (job status 3, Table 6-2).

You will find more information on data errors in the parameter initialization tool under the menu command **Debug > Error Evaluation** and in Chapter 11.

Performance in the event of an error during the servicing of a **Write request** (does not apply to single functions and commands):

- The Initiate signal is removed for the errored request and the Error signal (AW-DB, DBX54.0 to 63.7) and Ready signal (AW-DB, DBX44.0 to 53.7) are set (job request status, point 3, Table 6-2).
- The Initiate signal is also removed for all pending Write requests and the Error signal set (job request status, point 4, Table 6-2).
- Any pending Read requests are serviced. The error code (AW-DB, DBW66) for each request is re-set if another error occurs.

Performance in the event of an error during the servicing of a **Read request**:

- The Initiate signal is removed for the errored Read and the Error signal set (job request status, point 5, Table 6-2).
- Any pending Read requests are serviced. The error code (AW-DB, DBW66) for each request is re-set if another error occurs.

Performance in the event of an error during servicing of **single functions and commands**:

- The Write request is not serviced in its entirety, and the Error signal is set (job request status, point 4, Table 6-2).
- The function set/reset which led to initiation of the Write request is not activated.

Processing write requests

Before Write requests can be processed, the data area associated with the Write request must first be initialized with the relevant values and the appropriate operating mode.

A Write request is initiated by setting the relevant job request number.

The following abbreviations are used in the Table below to indicate the adjacent operating mode:

- Operating mode:** T – Jogging mode
 STE – Control mode
 REF – Approach to reference point
 SM – Incremental mode (relative)
 MDI – MDI (Manual Data Input)
 A/AE – Automatic mode / Automatic single block

The following Write requests are available:

Operating Mode System Data	Write Request	Data	T	STE	REF	SM	MDI	A/AE	See Sect.
Speed levels 1, 2	DBX38.0	DBB160...167	<input type="checkbox"/>	<input type="checkbox"/>	<input type="checkbox"/>	<input type="checkbox"/>	<input type="checkbox"/>	<input type="checkbox"/>	9.2.1
Frequency levels 1, 2	DBX38.1	DBB168...175	<input type="checkbox"/>	<input type="checkbox"/>	<input type="checkbox"/>	<input type="checkbox"/>	<input type="checkbox"/>	<input type="checkbox"/>	9.2.2
Setpoint for incremental dimension	DBX38.2	DBB156...159	<input type="checkbox"/>	<input type="checkbox"/>	<input type="checkbox"/>	<input type="checkbox"/>	<input type="checkbox"/>	<input type="checkbox"/>	9.2.4
MDI block	DBX38.3	DBB176...195	<input type="checkbox"/>	<input type="checkbox"/>	<input type="checkbox"/>	<input type="checkbox"/>	<input type="checkbox"/>	<input type="checkbox"/>	9.2.5
MDI block, on-the-fly	DBX38.4	DBB222...241	–	–	–	–	x	–	9.2.5
Reserved	DBX38.5								
Set reference point	DBX38.6	DBB152...155	x	x	x	x	x	–	9.3.9
Set actual value	DBX38.7	DBB144...147	x	x	–	x	x	x	9.3.5
Set on-the-fly actual value	DBX39.0	DBB148...151	x	x	–	x	x	–	9.3.6
Zero offset	DBX39.1	DBB140...143	x	x	–	x	x	x	9.3.4
Reserved	DBX39.2		x	x	x	x	x	x	
Modify parameters/data	DBX39.3	DBB196...219	x	x	x	x	x	x	9.3.1
Digital outputs	DBX39.4	DBB220...221	x	x	x	x	x	x	9.8.2
Program selection	DBX39.5	DBB242...245	–	–	–	–	–	<input type="checkbox"/>	9.2.6
Application request	DBX39.6	DBB246...249	x	x	x	x	x	x	9.3.7
Teach-in	DBX39.7	DBB250...251	x	–	–	x	x	–	9.3.8

- Data are accepted, then processed in the relevant operating mode.
- Data are accepted or processed.
- Data are rejected with error (see error handling, Table 11-8 column 4, No. 1).
- Data required to move the axis.

Processing read requests

A Read request is initiated by setting the relevant job request number. The relevant operating mode must be activated.

The following Read requests are available:

Operating Mode System Data	Read Request	Data	T	STE	REF	SM	MDI	A/AE	See Sect.
Basic operating data	DBX42.0	DBB310...333	x	x	x	x	x	x	9.3.11
Active NC block	DBX42.1	DBB342...361						x	9.3.12
Next NC block	DBX42.2	DBB362...381						x	
Actual value for block change	DBX42.3	DBB398...401						x	9.3.14
Service data	DBX42.4	DBB402...433	x	x	x	x	x	x	9.3.15
Operating error number	DBX42.5	DBB86...89	x	x	x	x	x	x	6.3.4
Suppl. operating data	DBX43.5	DBB434...442	x	x	x	x	x	x	9.3.16
Parameters/data	DBX43.3	DBB446...469	x	x	x	x	x	x	9.3.17
Digital inputs/outputs	DBX43.4	DBB220...221	x	x	x	x	x	x	9.8
Application data	DBX43.6	DBB382...397	x	x	x	x	x	x	9.3.13
Read measured values	DBX43.7	DBB486...497	x	x	x	x	x	x	9.3.10 6.3.5

x Data are accepted or processed.

Operating mode control

The operating modes are discussed in detail in Section 9.2, the control-/checkback signals and handling information in Section 9.1.

The user must write the control signals to the user data block (AW-DB). POS_CTRL transfers the control signals from user data block AW-DB to the FM 353 and the checkback signals from the FM 353 to user data block AW-DB. The FM must be initialized.

The Table below lists the control and checkback signals, with symbols in German and English.

Table 6-3 Control/checkback signals



German	English	AW-DB	Description
Control signals			
TFB	TEST_EN	DBX14.1	Switch P bus interface to "Start-up"
BFQ/FSQ	OT_ERR_A	DBX14.3	Acknowledge operator errors and traversing errors
ST	START	DBX15.0	Start
STP	STOP	DBX15.1	Stop

Table 6-3 Control/checkback signals

German	English	AW-DB	Description																
R-	DIR_M	DBX15.2	Negative direction																
R+	DIR_P	DBX15.3	Positive direction																
QMF	ACK_MF	DBX15.4	Acknowledge M function																
EFG	READ_EN	DBX15.5	Read Enable																
SA	SKIP_BLK	DBX15.6	Skip block																
AF	DRV_EN	DBX15.7	Drive enable																
BA	MODE_IN	DBB16	<table border="0"> <tr> <td>Operating mode</td> <td>Code</td> </tr> <tr> <td>Jog</td> <td>01</td> </tr> <tr> <td>Control</td> <td>02</td> </tr> <tr> <td>Approach to reference point</td> <td>03</td> </tr> <tr> <td>Incremental mode, relative</td> <td>04</td> </tr> <tr> <td>MDI</td> <td>06</td> </tr> <tr> <td>Automatic</td> <td>08</td> </tr> <tr> <td>Automatic single block</td> <td>09</td> </tr> </table>	Operating mode	Code	Jog	01	Control	02	Approach to reference point	03	Incremental mode, relative	04	MDI	06	Automatic	08	Automatic single block	09
Operating mode	Code																		
Jog	01																		
Control	02																		
Approach to reference point	03																		
Incremental mode, relative	04																		
MDI	06																		
Automatic	08																		
Automatic single block	09																		
BP	MODE_TYPE	DBB17	<table border="0"> <tr> <td>Operating mode parameters</td> <td>Code</td> </tr> <tr> <td>Speed levels</td> <td>1 and 2</td> </tr> <tr> <td>Frequency levels</td> <td>1 and 2</td> </tr> <tr> <td>Incremental dimension selection</td> <td>1...100, 254</td> </tr> </table>	Operating mode parameters	Code	Speed levels	1 and 2	Frequency levels	1 and 2	Incremental dimension selection	1...100, 254								
Operating mode parameters	Code																		
Speed levels	1 and 2																		
Frequency levels	1 and 2																		
Incremental dimension selection	1...100, 254																		
OVERR	OVERRIDE	DBB18	Override																
Checkback signals																			
TFGS	TST_STAT	DBX22.1	Switching of P BUS interface completed																
BF/FS	OT_ERR	DBX22.3	Operator-/traversing error																
DF	DATA_ERR	DBX22.4	Data error																
PARA	PARA	DBX22.7	Channel initialized																
SFG	ST_ENBLD	DBX23.0	Start Enable																
BL	WORKING	DBX23.1	Process in progress																
WFG	WAIT_EI	DBX23.2	Wait for external Enable																
T-L	DT_RUN	DBX23.5	Dwell time running																
PBR	PR_BACK	DBX23.6	Reverse program scanning																
BAR	MODE_OUT	DBB24	Active operating mode																
SYN	SYNC	DBX25.0	Channel synchronized																
ME	MSR_DONE	DBX25.1	End of measurement																
FR-	GO_M	DBX25.2	Travel in negative direction																
FR+	GO_P	DBX25.3	Travel in positive direction																
SFRG	ST_SERVO	DBX25.4	Servo enable status																
FIWS	FVAL_DONE	DBX25.5	Setting of on-the-fly actual value successfully completed																
PEH	POS_RCD	DBX25.7	Position reached. Stop.																
MNR	NUM_MF	DBB26	M function number																
AMF	STR_MF	DBX27.4	M function modification																

The checkback signals “Process in progress” and “Position reached. Stop” are not reported back to the user program until the FM has detected and processed the Start signal (≤ 2 FM cycles).

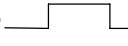
When calling the POS_CTRL block and the relevant control/checkback signals, the subsequent signals are generated so that starting of the procedure can be detected earlier than would otherwise be the case.

Signal	Description
Execution started (AW-DB, DBX13.6)	<p>= TRUE When a mode/movement is started with the relevant control signals or when the status for “Process in progress” (AW-DB, DBX23.1) = 1</p> <p>“Execution started”  when the block is called/started</p> <p>“Process in progress”  when the FM starts traversing movement</p>
Position (AW-DB, DBX13.7)	<p>= FALSE When status signal “Position reached. Stop.” (AW-DB, DBX25.7) = 0 is returned or when a mode is started with the relevant control signals.</p> <p>“Position”  when the block is called/started</p> <p>“Position reached. Stop”  when FM starts traversing movement</p>

Single functions and single commands are also required to control the FM 353.

All single commands and single functions that are active when the POS_CTRL block is called are transferred. The single commands are cancelled following transfer, even in the event of an error.

Operating Modes System Data	Write Request	Function	T	STE	REF	SM	MDI	A/AE	See Sect.
Single functions	Internal	DBB34 and 35	<input type="checkbox"/>	x	<input type="checkbox"/>	<input type="checkbox"/>	<input type="checkbox"/>	<input type="checkbox"/>	9.3.2
Single commands	Internal	DBB36 and 37	x	x	x	x	x	x	9.3.3

- x Data are accepted or processed.
- Data required to move the axis.

The functions which can be activated in the FM using single settings or single commands are listed below.

Single Settings	Single Commands
Servo enable On-the-fly measuring Rotational speed monitoring Parking axis Simulation Length measuring Retriggering of reference point Reset Enable input Disable software limit position monitoring	Activate machine data Delete distance to go Automatic block return Automatic block advance Restart Rescind set actual value

Error messages from the FM

When an operator error, traversing error or data error occurs, the error number is read automatically via a Read request. The error number is entered in the AW-DB user data block and the Read status set.

An operating error, reported via a diagnostic interrupt, can be read out with the Read request "Operating error no." (AW-DB, DBX42.5).

Table 6-4 Error messages from the FM

Error	Message	Error No.	Error Acknowledgement
Data error	Status signal (AW-DB, DBX22.4)	Is read out via Read request (AW-DB, DBB94 and 95)	New Write request
Operator/traversing error	Status signal (AW-DB, DBX22.3)	Is read out via Read request (AW-DB, DBB 90 and 91)	Set/reset control signal "Acknowledge operator/traversing error" (AW-DB, DBX14.3)
Diagnostic interrupt	Activated with OB 82, the data must be read out using the POS_DIAG block	In case of an operating error read out via the POS_DIAG block, the error no. is read out via the Read request DBX42.5 (AW-DB, DBB86 and 87)	Single command: Restart

For additional specific information, please refer to Chapter 11 "Error Handling".

6.3.4 The POS_DIAG (FC 2) block – Read diagnostic interrupt data

In the event of a fatal error, the FM 353 generates a diagnostic interrupt (OB 82 must be embedded in the user program and the interrupt parameterization of the FM 353 must be activated) and provides the relevant information to the local data area. For information on diagnostic interrupts, see Section 6.5.

For further information on external channel errors (operating errors), please call the POS_DIAG block.

Call options

POS_DIAG can be called in interrupt OB 82 or in OB 1.

Call in LAD representation (ladder diagram)	Call in STL representation (statement list)
	<pre>CALL POS_DIAG DB_NO := RET_VAL := IN_DIAG :=</pre>

Parameters

The Table below lists the parameters for the POS_DIAG block.

Name	Data type	Param. type	Description
DB_NO	INT	I	Data block number
RET_VAL	INT	Q	-1
IN_DIAG	BOOL	I/Q	Initiation signal for reading of the diagnostic data; is reset following execution of POS_DIAG.

Parameter types: I = input parameter, Q = output parameter,
I/Q = throughput parameter (initiation parameter)

Function description

The function works together with an AW-DB user data block. When the function is called, the AW-DB is forwarded with a DB_NO parameter.

Reading of the diagnostic data is started by setting the IN_DIAG parameter to TRUE. The block resets the parameter when the request has been serviced.

The IN_DIAG parameter remains set while the request is being serviced. Transfer of the data is terminated when the parameter is reset (IN_DIAG = FALSE).

Error evaluation

Errors are flagged in the Binary Result (BR = 0) and by RET_VAL < 0.

Possible errors are as follows:

Data transfer error during transfers with SFC 51 "RDSYSST". The error is made available in the user DB AW-DB, DBW96 (see Error List, Section 6.8).

Diagnostic data

The prerequisite for the generation of a diagnostic interrupt is activation of the interrupt with the aid of the appropriate parameters (see Section 5.2).

If the user program does not contain an OB 82, the CPU goes to STOP.

The Table below contains the diagnostic information for the FM 353.

Table 6-5 Diagnostic information

Data Format	Message	User DB	Description
4 x 1 byte	When a diagnostic interrupt is generated, the relevant information is made available in the CPU (local data area, OB 82) and is entered in AW-DB by calling POS_DIAG.	DBX70.0	Module/group errors
		DBX70.1	Internal error/hardware error (group error bytes 72, 73)
		DBX70.2	External error
		DBX70.3	External channel error (group error byte 78)
		DBX70.6	Module not initialized
		DBX71.0 ...3	Module type class for FM 353 = 08H
		DBX71.4	Channel information available
		DBX72.1	Communication error (K bus)
		DBX72.3	Response from watchdog timer
		DBX72.4	Internal supply voltage to the module failed (NMI)
		DBX73.2	FEPROM error
		DBX73.3	RAM error
		DBX73.6	Process interrupt lost

Table 6-5 Diagnostic information, continued

Data Format	Message	User DB	Description
10 x byte	When the POS_DIAG block is called, the information (incl. bytes 0 to 3) is read and entered in the AW-DB (DBB70). When an operating error occurs, the error number can be read via Read request DBX42.5 (AW-DB, DBB86 to 89)	DBB74	FM pos. ID (74H)
		DBB75	Length of the diagnostic information (16)
		DBB76	Number of channels (1)
		DBX77	Channel vector error (1)
		DBX78.0 ...5	Unassigned
		DBX78.7	Operating error (see Chapter 11, Troubleshooting)
		DBB79... 83	Unassigned

Tips for the user

Following a diagnostic interrupt, the diagnostic information and the associated module address (OB82_MDL_ADDR) is made available in the local data area of OB 82 for quick analysis.

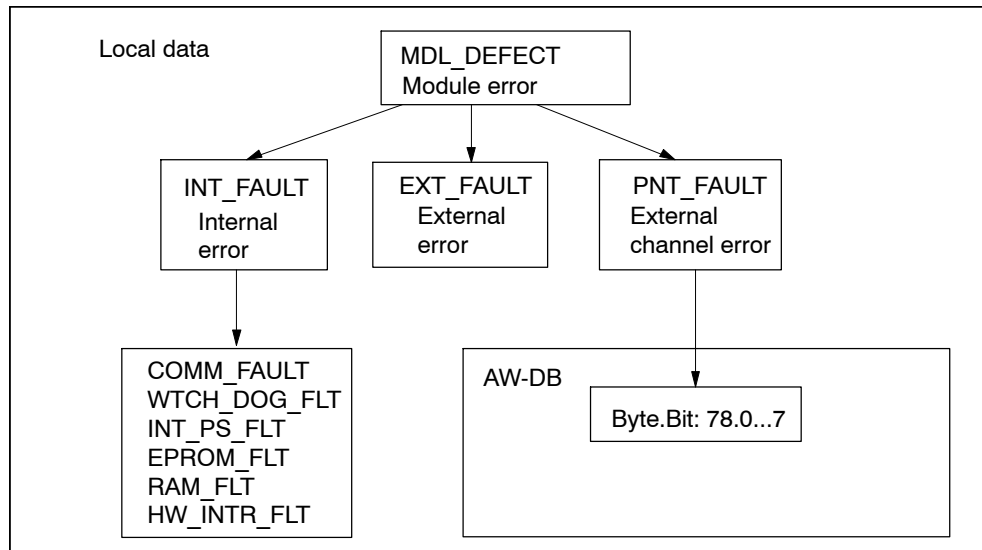

Fig. 6-3 Evaluating diagnostic data

6.3.5 The POS_MSRRM (FC 3) block – Read measured values

Function

Use the POS_MSRRM block to read the measured values from the AW-DB user data block.

For information on process interrupts, please see Section 6.5.

For information on measured values 9.3.10.

Note

The measured values can also be read by means of POS_CTRL (Read request). If more than one Read request is pending, this request will be processed in the relevant order.

If the POS_MSRRM block is called, the measured values are obtained irrespective of any other Read requests currently present.

Call options

POS_MSRRM can be called in OB 40 (only when FM is used centralized) if the process interrupt was triggered (see Section 5.2), or in OB 1. POS_MSRRM must not be called in both OBs at the same time.

Call in LAD representation (ladder diagram)	Call in STL representation (statement list)
	<pre>CALL POS_MSRRM DB_NO := RET_VAL := IN_MSR :=</pre>

Parameters

The Table below lists the parameters for the POS_MSRRM block.

Name	Data type	Param. type	Description
DB_NO	INT	I	Data block number
RET_VAL	INT	Q	-1
IN_MSR	BOOL	I/Q	Start Read

Parameter types: I = input parameter, Q = output parameter,
I/Q = throughput parameter (initiation parameter)

Function description

The function works together with an AW-DB user data block. When the function is called, the DB number is forwarded in the DB_NO parameter.

Reading of the measured value is started by setting the IN_MSR parameter to TRUE. When the function has executed, the block resets the parameter.

The IN_MSR parameter remains set while the function is executing. Transfer of the data is terminated is complete when the parameter is reset (IN_MSR = FALSE).

Error evaluation

Errors are flagged in the Binary Result (BR = 0) and by RET_VAL < 0.

Possible errors are as follows:

Data transfer errors during transfers with SFC 59 "RD_REC". The error is made available in the user data block AW-DB, DBW98 (see Error List, Section 6.8).

6.3.6 Interface, user data blocks (AW-DBs)

The AW-DB (interface) is created off-line.

The user can access the signals and/or data on the interface using absolute or symbolic addresses (creation of the AW-DB with UDT structure).

The interface is allocated to the relevant channel/axis via the standard function blocks' DB_NO input parameter. The module address is part of the user DB. It is entered either by the POS_INIT block or manually via "Parameterize FM 353" (button "Enter Mod-Adr in user DB" in main display). The user DB must already exist.

Creating the AW-DB

Proceed as follows:

1. Open your project and select **SIMATIC xxx > CPUxxx > S7 Program > Blocks**.
2. The data block (for example DB 1) is generated under STEP 7 with the menu command **Insert > S7 Block > Data Block**.
3. The LAD/STL/FBD editor is started by double-clicking on this data block.
4. In the “New data block” dialog, select “Data block with assigned user-specific data type”.
5. UDT 1 is displayed.
UDT 1 contains the structure of the AW-DB.
6. Select UDT 1 and confirm with **OK**.
7. You have now created the AW-DB.
8. Save this AW-DB with **File > Save**.
9. Close the editor.

Information about symbolic programming

Normally, the blocks are entered in the symbol table with the symbol name, address, and data type (the symbol table is supplied in the project and in the library). If you change the block number in your project with the SIMATIC Manager, the numbering in the symbol table must also be changed. Block allocation via the symbol table is always absolutely unique.

Before writing and compiling your user program, you must enter the blocks (AW-DBs, FCs) which you are using for your particular configuration in the symbol table. The symbolic structure of the interface is stored in the UDT block provided. The symbolic relationship is established via your STEP 7 project, the symbol table, and the UDT block.

Appendix B shows the UDT with symbols and absolute address.

Sample symbol table:

Symbol	Address	Data Type	Comments
DB_FM1	DB 1	UDT 1	User DB for the FM 354
POS_INIT	FC 0	FC 0	User DB initialization
POS_CTRL	FC 1	FC 1	Data interchange

6.4 Standard function blocks of the “FM353_354” block library (also for PROFINET, upon request)

Overview

The present chapter provides the following information:

- Overview of the “FM353_354” block library, Section 6.4.1, p. 6-28
- POS_INIT (FC 0) – Initializing the user data block (AW-DB), Section 6.4.2, p. 6-30
- POS_CTRL (FB 1) – Data exchange, Section 6.4.3, p. 6-30
- POS_DIAG (FC 2) – Reading diagnostic interrupt data, Section 6.4.4, p. 6-41
- POS_MSRL (FB 3) – Reading measured values, Section 6.4.5, p. 6-41
- Interface, user data blocks (AW-DB), Section 6.4.6, p. 6-42

6.4.1 Overview of the “FM353_354” block library

You can use the blocks of the “FM353_354” block library as follows:

- centralized configuration of the FM
- distributed configuration of the FM via PROFIBUS DP
- distributed configuration of the FM via PROFINET

Note

The blocks of the “FM353_354” block library requires the following firmware version on the CPU:

- CPU modules with MMC with firmware V2.0 and higher
 - CPU318 with firmware V3.0 and higher
-

The table below provides an overview of the functions (FC), function blocks (FB), data blocks (DB) and organization blocks (OB) required for communication and control of the FM 353.

Table 6-6 Standard function blocks of the "FM353_354" block library (overview)

Block	Block Name	Description/Function	Remarks
FC 0 Page 6-30	POS_INIT	Call in OB 100 and OB 86, start-up/initialization	Required for application, number can be changed ¹⁾
FB 1 Page 6-30	POS_CTRL	Call in OB 1, cyclic operation (synchronization with the FM 353) Basic functions and operating modes, interface processing, read and write requests	
FB 2 Page 6-41	POS_DIAG	Call in OB 82, internal errors, external errors, and external channel errors of the FM	
FB 3 Page 6-41	POS_MSVM	Call in OB 40 or OB 1, reading out of the measured values	To be used only if the function in question is required for the application in question; the number can be changed ¹⁾
DB 1	IFFM_ICTRL	Interface to the FM and instance DB for POS_CTRL (FB 1)	Required for application, number can be changed ¹⁾
DB 3	IMSRM	Instance DB for POS_MSVM (FB 3)	Required for application if POS_MSVM is called; number can be changed ¹⁾
OB 1	–	Cyclic level	Required for application
OB 82	–	Diagnostic interrupt level	
OB 100	–	Start-up level	
OB 86	–	Subrack failure	For distributed configurations
OB 122	–	I/O access error	

- 1) – **The block number is a default setting**, block number can be changed in the SIMATIC Manager
 – Symbol table entries can only be changed in conjunction with symbolic programming

Note

The symbolic block identifier is used from here on.

6.4.2 The POS_INIT (FC 0) block – Initialization

Block description

See Section 6.3.2.

6.4.3 The POS_CTRL (FC 1) block – Data exchange

Function

The POS_CTRL block is the basic block for controlling the FM 353.

With the POS_CTRL block, you can:

- process read and write requests
- control the operating modes (control and checkback signals)

The POS_CTRL block performs the following actions:

1. Synchronization with the module (only then is the exchange of signals/data possible).
2. Reading of the checkback signals. The values/signals read by the POS_CTRL block are stored in the user data block AW-DB.
3. Transfer of the control signals from user data block AW-DB to the FM 353.
4. Carrying out of Write requests from user data block AW-DB, which includes the transfer of associated data from AW-DB and setting of the job status for the Write. Before the function is activated, all data required for the execution of the intended functions must be entered in AW-DB.
5. Carrying out of Read requests from user data block AW-DB, which includes transfer of the associated data to AW-DB and setting of the Read job status.
6. Automatic transfer of all single functions from user data block AW-DB to the FM 353 when one or more than one setting has been changed and setting of the Write job status (Set or Reset).
7. Automatic transfer of all single commands from user data block AW-DB to the FM 353 and setting of the Write job status. The single commands are reset following the transfer.
8. Automatic reading of the error number when an operator input error, traversing error or data error has occurred. The error number is entered in user data block AW-DB (DBB90 to DBB97) and the Read job status set.

Call options

The POS_CTRL block requires an instance data block (DB) when called. The DB IFFM_ICTRL (DB1) is part of the “FM353_354” library and at the same time includes the user interface. For more information, please refer to Section 6.4.6.

You must call the POS_CTRL block cyclically (e.g. once in the OB 1 cycle). Before you call the function, enter all data/signals in the user DB (AW-DB) which are required to execute the intended functions.

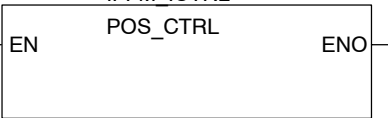
Call in LAD representation (ladder diagram)	Call in STL representation (statement list)
	<pre>CALL POS_CTRL, IFFM_ICTRL</pre>

Parameters

The POS_CTRL block possesses neither input, nor output parameters.

Return values

The POS_CTRL block delivers the following return values in the RETVAL instance variable:

RET_VAL	BR	Description
1	1	At least 1 job/transfer in progress
0	1	No job/transfer in progress, no error
< 0	0	Error: <ul style="list-style-type: none"> Data error (AW-DB, DBX22.4) Communication error (AW-DB, DBW66)

Function description

The block operates with an AW-DB user data block. The DB number is determined when calling the FB using a transferred instance DB.

- **Start-up**

POS_CTRL acknowledges start-up of the module. During this time, the RETVAL parameter and the “Write/Read job in progress” signals (AW-DB, DBX68.0 and DBX68.2) are TRUE.

- **Control and checkback signals**

When POS_CTRL is called, the checkback signals are read from the FM 353 immediately (via direct access). Since the control signals and job requests are processed after these signals have been read, the checkback signals reflect the status of the module before the block was called. The control signals are also written to the FM 353 using direct access.

Depending on the chosen mode, the control signals “Start, “Negative direction” and “Positive direction” (AW-DB, DBX15.0, 15.2 and 15.3) are reset once start-up has actually taken place (edge formation of the signals for the FM).

For information on the generation of the checkback signals “Process” (AW-DB, DBX13.6) and “Position” (AW-DB, DBX13.7), see “Mode control”.

- **Job requests**

Data interchange with the module that goes beyond control and checkback signals is handled using job requests. Simultaneously pending Write or Read requests, however, can only be executed in succession, whereby one Read and one Write request are processed in one call.

To issue a request, set the relevant initiation signal in user data block AW-DB (DBB38 to DBB43). In the case of Write requests, you must also make the appropriate data available.

The request is serviced when POS_CTRL is called. When the FM is used centralized, a Read request is performed during the call. A Write request requires at least three calls (or OB cycles) due to the acknowledgements required from the module. The time interval between the calls should exceed the length of one FM cycle.

When a request has been serviced, the Initiate signal is removed (does not apply to single functions).

The next job request is not determined or executed until the next block call has been made.

For each job request, there is a Ready signal (AW-DB, DBX44.0 to 53.7) and an Error signal (AW-DB, DBX54.0 to 63.7) in addition to the Initiate signal.

You should reset the Ready and Error signals for a job request following evaluation or prior to issuing the request.

- **Order in which job requests are serviced/priority**

You may submit several job requests simultaneously, even together with Write requests for single commands and single functions.

As soon as a Write request is detected (also on a signal change in the case of single functions), it is serviced immediately upon completion of the transfer currently in progress, if any. Be sure that signals for single commands are not set cyclically, as this could prevent other job requests from being serviced (priority).

Order/priority of Write requests:

1. Write single commands
2. Write single functions
3. Write requests.
The Write requests are serviced in the order of the Initiate signals, which is stipulated in user data block AW-DB (from DBX38.0 to 39.7).

Order/priority of Read requests:

1. Read error code, operator/traverse errors or data errors
2. Read requests
The Read requests are serviced in the order of the Initiate signals, which is stipulated in user data block AW-DB (from DBX42.0 to 43.6).

- **Job request status**

You can read the status of the job processing infrom the RETVAL instance variable of the block and from the "Write/read job in progress" signals in user data block AW-DB (DBX68.0 and DBX68.2). You can evaluate the status of an individual job request by evaluating the Initiate, Ready and Error signals for that job request.

Table 6-7 Job request status

Job request status	RETVAl instance variable (integer)	Jobs in progress (DBX68.0 DBX68.2)	Initiate signals (DBB34...43)	Ready signals (DBB44...53)	Error signals (DBB54...63)
1. Job in progress	1	1	1	–	–
2. Job completed without errors	0	–	–	1	–
3. Write job completed with errors in this job	–1	–	–	1	1
4. Write job aborted or not executed	–1	–	–	–	1
5. Read job aborted	–2	–	–	–	1
6. Write and Read aborted or not executed (in case of simultaneous job requests)	–3	–	–	–	1

– Irrelevant for error evaluation

Processing status

Signal	Description
Write not possible (AW-DB, DBX68.1)	= TRUE; Write request cannot be processed in this cycle because: <ul style="list-style-type: none"> • The axis is not initialized • Test mode is enabled • No operating mode is active • The selected operating mode has not yet been set In these cases, you can leave the Write request pending or you can cancel it. The POS_CTRL block resets the signal when all of the above-listed conditions are fulfilled.
Read not possible (AW-DB, DBX68.3)	= TRUE; Read request cannot be serviced at this time because: <ul style="list-style-type: none"> • The axis is not initialized • No mode has been selected • Test mode is enabled In these cases, you can leave the Read request pending or you can cancel it. The POS_CTRL block resets the signal when all of the above-listed conditions are fulfilled.
Reset status/error (AW-DB, DBX69.1)	With this signal you can reset all Ready and Error signals prior to processing of the pending job requests. The signal itself is then reset by the block.

Error evaluation

Communication errors or data interpretation errors on the FM are flagged in the Binary Result (BR = 0) and by instance variable RETVAL < 0; see job request status.

Possible errors are:

- Data transfer error (communication is not completed) during a transfer with SFC 58/59 "RDREC / WRREC". The error code is made available in user data block AW-DB, DBW66 (RET_VAL value of these internal SFBs) (job states 4, 5 and 6, see Table 6-7, see also Error List, Section 6.8).
- Data transferred with Write are checked for data errors by the module and interpreted. If a data error occurs, the checkback signal "Data error" (AW-DB, DBX22.4) is set to TRUE in user data block AW-DB (message: "Write job terminated with error"). The error number, read out via an internal job request, is entered in user data block AW-DB, DBB94 and 95 (job status 3, Table 6-7).

You will find more information on data errors in the parameter initialization tool under the menu command **Debug > Error Evaluation** and in Chapter 11.

Performance in the event of an error during the servicing of a **Write request** (does not apply to single functions and commands):

- The Initiate signal is removed for the errored request and the Error signal (AW-DB, DBX54.0 to 63.7) and Ready signal (AW-DB, DBX44.0 to 53.7) are set (job request status, point 3, Table 6-7).
- The Initiate signal is also removed for all pending Write requests and the Error signal set (job request status, point 4, Table 6-7).
- Any pending Read requests are serviced. The error code (AW-DB, DBW66) for each request is re-set if another error occurs.

Performance in the event of an error during the servicing of a **Read request**:

- The Initiate signal is removed for the errored Read and the Error signal set (job request status, point 5, Table 6-7).
- Any pending Read requests are serviced. The error code (AW-DB, DBW66) for each request is re-set if another error occurs.

Performance in the event of an error during servicing of **single functions and commands**:

- The Write request is not serviced in its entirety, and the Error signal is set (job request status, point 4, Table 6-7).
- The function set/reset which led to initiation of the Write request is not activated.

Processing write requests

Before Write requests can be processed, the data area associated with the Write request must first be initialized with the relevant values and the appropriate operating mode.

A Write request is initiated by setting the relevant job request number.

The following abbreviations are used in the Table below to indicate the adjacent operating mode:

- Operating mode:** T – Jogging mode
 STE – Control mode
 REF – Approach to reference point
 SM – Incremental mode (relative)
 MDI – MDI (Manual Data Input)
 A/AE – Automatic mode / Automatic single block

The following Write requests are available:

Operating Mode System Data	Write Request	Data	T	STE	REF	SM	MDI	A/AE	See Sect.
Speed levels 1, 2	DBX38.0	DBB160...167	□	○	○	□	○	○	9.2.1
Frequency levels 1, 2	DBX38.1	DBB168...175	○	□	○	○	○	○	9.2.2
Setpoint for incremental dimension	DBX38.2	DBB156...159	○	○	○	□	○	○	9.2.4
MDI block	DBX38.3	DBB176...195	○	○	○	○	□	○	9.2.5
MDI block, on-the-fly	DBX38.4	DBB222...241	–	–	–	–	x	–	9.2.5
Reserved	DBX38.5								
Set reference point	DBX38.6	DBB152...155	x	x	x	x	x	–	9.3.9
Set actual value	DBX38.7	DBB144...147	x	x	–	x	x	x	9.3.5
Set on-the-fly actual value	DBX39.0	DBB148...151	x	x	–	x	x	–	9.3.6
Zero offset	DBX39.1	DBB140...143	x	x	–	x	x	x	9.3.4
Reserved	DBX39.2		x	x	x	x	x	x	
Modify parameters/data	DBX39.3	DBB196...219	x	x	x	x	x	x	9.3.1
Digital outputs	DBX39.4	DBB220...221	x	x	x	x	x	x	9.8.2
Program selection	DBX39.5	DBB242...245	–	–	–	–	–	□	9.2.6
Application request	DBX39.6	DBB246...249	x	x	x	x	x	x	9.3.7
Teach-in	DBX39.7	DBB250...251	x	–	–	x	x	–	9.3.8

- Data are accepted, then processed in the relevant operating mode.
- x Data are accepted or processed.
- Data are rejected with error (see Error Handling, Table 11-8 column 4, No. 1).
- Data required to move the axis.

Processing read requests

A Read request is initiated by setting the relevant job request number. The relevant operating mode must be activated.

The following Read requests are available:

Operating Mode System Data	Read Request	Data	T	STE	REF	SM	MDI	A/AE	See Sect.
Basic operating data	DBX42.0	DBB310...333	x	x	x	x	x	x	9.3.11
Active NC block	DBX42.1	DBB342...361						x	9.3.12
Next NC block	DBX42.2	DBB362...381						x	
Actual value for block change	DBX42.3	DBB398...401						x	9.3.14
Service data	DBX42.4	DBB402...433	x	x	x	x	x	x	9.3.15
Operating error number	DBX42.5	DBB86...89	x	x	x	x	x	x	6.3.4
Suppl. operating data	DBX43.5	DBB434...442	x	x	x	x	x	x	9.3.16
Parameters/data	DBX43.3	DBB446...469	x	x	x	x	x	x	9.3.17
Digital inputs/outputs	DBX43.4	DBB220...221	x	x	x	x	x	x	9.8
Application data	DBX43.6	DBB382...397	x	x	x	x	x	x	9.3.13
Read measured values	DBX43.7	DBB486...497	x	x	x	x	x	x	9.3.10 6.3.5

x Data are accepted or processed.

Operating mode control

The operating modes are discussed in detail in Section 9.2, the control-/checkback signals and handling information in Section 9.1.

The user must write the control signals to the user data block (AW-DB). The POS_CTRL block transfers the control signals from user data block AW-DB to the FM 353 and the checkback signals from the FM 353 to user data block AW-DB. The FM must be initialized.

The Table below lists the control and checkback signals, with symbols in German and English.

Table 6-8 Control/checkback signals



German	English	AW-DB	Description
Control signals			
TFB	TEST_EN	DBX14.1	Switch P bus interface to "Start-up"
BFQ/FSQ	OT_ERR_A	DBX14.3	Acknowledge operator and traversing errors
ST	START	DBX15.0	Start
STP	STOP	DBX15.1	Stop
R-	DIR_M	DBX15.2	Negative direction

Table 6-8 Control/checkback signals

German	English	AW-DB	Description																
R+	DIR_P	DBX15.3	Positive direction																
QMF	ACK_MF	DBX15.4	Acknowledge M function																
EFG	READ_EN	DBX15.5	Read Enable																
SA	SKIP_BLK	DBX15.6	Skip block																
AF	DRV_EN	DBX15.7	Drive enable																
BA	MODE_IN	DBB16	<table border="0"> <tr> <td>Operating mode</td> <td>Code</td> </tr> <tr> <td>Jog</td> <td>01</td> </tr> <tr> <td>Control</td> <td>02</td> </tr> <tr> <td>Approach to reference point</td> <td>03</td> </tr> <tr> <td>Incremental mode, relative</td> <td>04</td> </tr> <tr> <td>MDI</td> <td>06</td> </tr> <tr> <td>Automatic</td> <td>08</td> </tr> <tr> <td>Automatic single block</td> <td>09</td> </tr> </table>	Operating mode	Code	Jog	01	Control	02	Approach to reference point	03	Incremental mode, relative	04	MDI	06	Automatic	08	Automatic single block	09
Operating mode	Code																		
Jog	01																		
Control	02																		
Approach to reference point	03																		
Incremental mode, relative	04																		
MDI	06																		
Automatic	08																		
Automatic single block	09																		
BP	MODE_TYPE	DBB17	<table border="0"> <tr> <td>Operating mode parameters</td> <td>Code</td> </tr> <tr> <td>Speed levels</td> <td>1 and 2</td> </tr> <tr> <td>Frequency levels</td> <td>1 and 2</td> </tr> <tr> <td>Incremental dimension selection</td> <td>1...100, 254</td> </tr> </table>	Operating mode parameters	Code	Speed levels	1 and 2	Frequency levels	1 and 2	Incremental dimension selection	1...100, 254								
Operating mode parameters	Code																		
Speed levels	1 and 2																		
Frequency levels	1 and 2																		
Incremental dimension selection	1...100, 254																		
OVERR	OVERRIDE	DBB18	Override																
Checkback signals																			
TFGS	TST_STAT	DBX22.1	Switching of P BUS interface completed																
BF/FS	OT_ERR	DBX22.3	Operator-/traversing error																
DF	DATA_ERR	DBX22.4	Data error																
PARA	PARA	DBX22.7	Channel initialized																
SFG	ST_ENBLD	DBX23.0	Start Enable																
BL	WORKING	DBX23.1	Process in progress																
WFG	WAIT_EI	DBX23.2	Wait for external Enable																
T-L	DT_RUN	DBX23.5	Dwell time running																
PBR	PR_BACK	DBX23.6	Reverse program scanning																
BAR	MODE_OUT	DBB24	Active operating mode																
SYN	SYNC	DBX25.0	Channel synchronized																
ME	MSR_DONE	DBX25.1	End of measurement																
FR-	GO_M	DBX25.2	Travel in negative direction																
FR+	GO_P	DBX25.3	Travel in positive direction																
SRFG	ST_SERVO	DBX25.4	Servo enable status																
FIWS	FVAL_DONE	DBX25.5	Setting of on-the-fly actual value successfully completed																
PEH	POS_RCD	DBX25.7	Position reached. Stop.																
MNR	NUM_MF	DBB26	M function number																
AMF	STR_MF	DBX27.4	M function modification																
ACT_POS	ACT_POS	DBD28	Actual position																

The checkback signals “Process in progress” and “Position reached. Stop” are not reported back to the user program until the FM has detected and processed the Start signal (≤ 2 FM cycles).

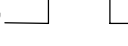
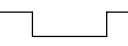
When calling the POS_CTRL block and the relevant control/checkback signals, the subsequent signals are generated so that starting of the procedure can be detected earlier than would otherwise be the case.

Signal	Description
Execution started (AW-DB, DBX13.6)	<p>= TRUE When a mode/movement is started with the relevant control signals or when the status for “Process in progress” (AW-DB, DBX23.1) = 1</p> <p>“Execution started”  when the block is called/started</p> <p>“Process in progress”  when the FM starts traversing movement</p>
Position (AW-DB, DBX13.7)	<p>= FALSE When status signal “Position reached. Stop.” (AW-DB, DBX25.7) = 0 is returned or when a mode is started with the relevant control signals.</p> <p>“Position”  when the block is called/started</p> <p>“Position reached. Stop”  when FM starts traversing movement</p>

Furthermore, various settings and commands are required to control the FM 353.

In all cases, those commands and settings are transferred which are activated at the time when the POS_CTRL block is called. The commands are canceled after the transfer, also in case of error.

Operating Modes System Data	Write Request	Function	T	STE	REF	SM	MDI	A/AE	See Sect.
Single functions	Internal	DBB34 and 35	<input type="checkbox"/>	x	<input type="checkbox"/>	<input type="checkbox"/>	<input type="checkbox"/>	<input type="checkbox"/>	9.3.2
Single commands	Internal	DBB36 and 37	x	x	x	x	x	x	9.3.3

- x Data are accepted or processed.
- Data required to move the axis.

The functions which can be activated in the FM using single settings or single commands are listed below.

Single Settings	Single Commands
Servo enable On-the-fly measuring Rotational speed monitoring Parking axis Simulation Length measuring Retriggering of reference point Reset Enable input Disable software limit position monitoring	Activate machine data Delete distance to go Automatic block return Automatic block advance Restart Rescind set actual value

Error messages from the FM

When an operator error, traversing error or data error occurs, the error number is read automatically via a Read request. The error number is entered in the AW-DB user data block and the Read status set.

An operating error, reported via a diagnostic interrupt, can be read out with the Read request "Operating error no." (AW-DB, DBX42.5).

Table 6-9 Error messages from the FM

Error	Message	Error No.	Error Acknowledgement
Data error	Status signal (AW-DB, DBX22.4)	Is read out via Read request (AW-DB, DBB94 and 95)	New Write request
Operator/traversing error	Status signal (AW-DB, DBX22.3)	Is read out via Read request (AW-DB, DBB 90 and 91)	Set/reset control signal "Acknowledge operator/traversing error" (AW-DB, DBX14.3)
Diagnostic interrupt	Activated with OB 82, the data must be read out using the POS_DIAG block	In case of an operating error read out via the POS_DIAG block, the error no. is read out via the Read request DBX42.5 (AW-DB, DBB86 and 87)	Single command: Restart

For additional specific information, please refer to Chapter 11 "Error Handling".

6.4.4 The POS_DIAG (FC 2) block – Read diagnostic interrupt data

Block description

See Section 6.3.4.

6.4.5 The POS_MSRRM (FC 3) block – Read measured values

Function

Use the POS_MSRRM block to read the measured values into the AW-DB user data block.

For information on process interrupts, please see Section 6.5.

For information on measured values, see Section 9.3.10.

Note

The measured values can also be read by means of POS_CTRL (Read request). If more than one Read request is present, this request is processed in the relevant order.

If the POS_MSRRM block is called, the measured values are obtained irrespective of any other Read requests currently present.

Call options

The POS_MSRRM block requires an instance DB when called.

The DB IMSRRM (DB 3) is part of the “FM353_354” library.

POS_MSRRM can be called in OB 40 (only when the FM is operated in the central configuration) if the process interrupt has been activated (see Section 5.2), or in OB 1. It is not possible to call POS_MSRRM in both OBs simultaneously.

Call in LAD representation (ladder diagram)	Call in STL representation (statement list)
	<pre>CALL POS_MSRRM, IMSRM DB_NO := RETVAL := IN_MSR :=</pre>

Parameters

The Table below lists the parameters for the POS_MSRL block.

Name	Data type	Param. type	Description
DB_NO	INT	I	Data block number
RETVAL	INT	Q	-1
IN_MSR	BOOL	I/Q	Start Read

Parameter types: I = input parameter, Q = output parameter,
I/Q = throughput parameter (initiation parameter)

Function description

The function works together with an AW-DB user data block. When the function is called, the DB number is forwarded in the DB_NO parameter.

Reading of the measured value is started by setting the IN_MSR parameter to TRUE. When the function has executed, the block resets the parameter.

The IN_MSR parameter remains set while the function is executing. Transfer of the data is terminated is complete when the parameter is reset (IN_MSR = FALSE).

Error evaluation

Errors are flagged in the Binary Result (BR = 0) and by RETVAL < 0.

Possible errors are as follows:

Data transfer errors during transfers with SFB 52 "RDREC". The error is made available in the user data block AW-DB, DBW98 (see Error List, Section 6.8).

6.4.6 Interface, user DBs (AW-DBs)

User DB 1 is the user data block in the default condition of the function blocks; it's symbolic name is IFFM_ICTRL. This DB consists of the user data interface and the instance data of the POS_CTRL block (FB 1).

The user can access the signals and/or data on the interface using absolute or symbolic addresses if reference is made via the symbol table of the project.

When calling POS_CTRL, the interface is transferred as an instance. With the other standard function blocks, the interface is assigned to the appropriate channel/axis using the DB_NO input parameter.

Note

If the POS_CTRL block is called for several channels/axes, a new instance DB of the POS_CTRL block is created for each individual channel/axis. To assign the data to the relevant channel/axis, this instance is always to be transferred when calling the block.

The module address is part of the user data block (AW-DB). It is entered either by the POS_INIT block or manually via "Parameterize FM 353" using the "Enter module address in the user data block" in the overview diagram. The user data block (AW-DB) must exist.

Information about symbolic programming

Normally, the blocks are entered in the symbol table with the symbol name, address, and data type; the symbol table is part of the project and included in the "FM353_354" block library. If you change the block numbers in your project using the SIMATIC Manager, the numbering in the symbol table must also be changed. The block assignment is provided unambiguously via the symbol table.

Before writing and compiling your user program, you must enter the blocks (AW-DB, FCs, FBs) in the symbol table according to your particular configuration. The symbolic structure of the interface is stored in the supplied instance data block DB 1 (IFFM_ICTRL). The symbolic reference is provided via your STEP 7 project – the symbol table.

The Annex shows the user interface with the appropriate symbols and with the absolute address.

Example symbol table:

Symbol	Address	Data type	Comments
IFFM_ICTRL	DB 1	FB 1	CPU / FM interface, instance DB to the POS_CTRL block
POS_INIT	FC 0	FC 0	Initialization
POS_CTRL	FC 1	FC 1	Operating modes, commands and data exchange

6.5 Interrupts

Interrupt processing

The FM 353 can generate process interrupts and diagnostic interrupts. You can process these interrupts only in an interrupt OB (OB 40 or OB 82). If an interrupt is generated without the associated OB having been loaded, the CPU goes to STOP (refer to the manual entitled *Programming with STEP 7*).

Interrupt servicing is enabled in the following stages:

1. General Interrupt Enable for the entire module:
 - Select the module in the hardware configuration.
 - Enable diagnostic and/or process interrupts with **Edit > Object Properties > Basic Parameters** (also see Figure 5.2).
 - Select the OB number for the process with **Edit > Object Properties > Addresses**.
 - Save and compile the hardware configuration.
 - Load the hardware configuration into the CPU.
2. Enable the events for the process interrupt in the machine data.

Evaluating a process interrupt

When the FM 353 generates a process interrupt, variable OB40_POINT_ADDR (or the corresponding variable in another process interrupt OB) contains the following information:

Table 6-10 Contents of doubleword OB40_POINT_ADDR

Byte	Bit 7	Bit 6	Bit 5	Bit 4	Bit 3	Bit 2	Bit 1	Bit 0
0				in-process measuring	On-the-fly block chang		Length measurement terminated	Position reached
1								
2								
3								

The reason for the interrupt is made available in byte 0.

Lost process interrupts

If servicing of a process interrupt in the process interrupt OB has not yet been terminated, the module “makes a note” of all subsequent process interrupt events. If an event re-occurs before a process interrupt could be generated, the module generates the diagnostic interrupt “process interrupt lost”.

Evaluating a diagnostic interrupt

Following a diagnostic interrupt, the diagnostic information is made available in the local data area of OB 82 for quick analysis. Call the POS_DIAG block to ascertain the exact cause of error (see Section 6.3.4).

6.6 User data block (AW-DB)

Overview

The Table below describes the structure of the user data block.

Table 6-11 User data block (AW-DB)

AW-DB								
FM 353								
Byte	Bit 7	Bit 6	Bit 5	Bit 4	Bit 3	Bit 2	Bit 1	Bit 0
General addresses								
DBW0	Module address (data type INT)							
DBW2 to DBB12	Reserved							
DBB13	Position	Execution started						
Control signals								
DBB14					Acknowledge operator/traversing error		Switch to P bus Start-up	
DBB15	Drive enable	Block skip	Read-in enable	Acknowledge M function	Positive direction	Negative direction	Stop	Start
DBB16	Operating mode							
DBB17	Operating mode parameters							
DBB18	Override							
DBB19 to DBB21	Reserved							
Checkback signals								
DBB22	Channel initialized			Data error	Operator/traversing error		Switch to P bus completed	
DBB23		Reverse prog. scan	Dwell in progress			Wait for external enable	Machining in progress	Start enable
DBB24	Active operating mode							
DBB25	Position reached. Stop.		On-the-fly setting of actual value completed	Servo enable status	Positive travel	Negative travel	End of measurement	Channel synchronized
DBB26	M function number							
DBB27				M function modification				

Table 6-11 User data block (AW-DB), continued

AW-DB FM 353								
Byte	Bit 7	Bit 6	Bit 5	Bit 4	Bit 3	Bit 2	Bit 1	Bit 0
DBD28	Actual position (with firmware version V3.7.6 and higher in conjunction with the blocks of the "FM353_354" library)							
DBW32	Reserved							
Initiation signals								
Initiation signals for single settings (switches); transfer through Write request when change occurs								
DBB34	Simulation	Parking axis	Rotation monitoring				In-process measuring	Controller enable
DBB35		Software limit positions disabled		Enable input disabled	Retrigger ref. point	Length measurement		
Initiation signals for single commands; transfer through Write request when change occurs (signals are reset following transfer)								
DBB36	Reserved							
DBB37		Rescind setting of actual value	Restart		Automatic block return	Automatic block advance	Delete residual distance	Activate MD
Initiation signals for Write requests								
DBB38	Set actual value	Set reference point		On-the-fly MDI block	MDI block	Setpoint for incremental dimension	Frequency levels 1, 2	Speed levels 1, 2
DBB39	Teach-in	Request application data	Program selection	Digital outputs	Modify parameters / data		Zero offset	On-the-fly setting of actual value
DBB40 to DBB41	Reserved							
Initiation signals for Read requests								
DBB42			Operating error no.	Service data	Actual value block change	Next NC block	Active NC block	Basic operating data
DBB43	Read measured values	Application data	Additional operating data	Dig. inputs/ outputs	Parameter/ data			

Table 6-11 User data block (AW-DB), continued

AW-DB								
FM 353								
Byte	Bit 7	Bit 6	Bit 5	Bit 4	Bit 3	Bit 2	Bit 1	Bit 0
Ready signals								
Status/checkback signals from POS_CTRL								
DBB44	Simulation	Parking axis	Rotation monitoring				In-process measuring	Controller enable
DBB45		Software limit positions disabled		Enable input disabled	Retrig. ref. point	Length measurement		
DBB46	Reserved							
DBB47		Rescind setting of actual value	Restart		Autom. block return	Autom. block advance	Delete residual distance	Activate MD
DBB48	Set actual value	Set reference point		On-the-fly MDI block	MDI block	Setpoint for incremental dimension	Frequency levels 1, 2	Speed levels 1, 2
DBB49	Teach-in	Request application data	Program selection	Digital outputs	Modify parameters/data		Zero offset	On-the-fly setting of actual value
DBB50 to DBB51	Reserved							
DBB52	Data error read	Operator/traversing error read	Operating error read	Service data	Actual value block change	Next NC block	Active NC block	Basic operating data
DBB53	Read measured values	Application data	Additional operating data	Dig. inputs/outputs	Parameter/data			

Table 6-11 User data block (AW-DB), continued

AW-DB								
FM 353								
Byte	Bit 7	Bit 6	Bit 5	Bit 4	Bit 3	Bit 2	Bit 1	Bit 0
Error signals								
Error messages from POS_CTRL								
DBB54	Simulation	Parking axis	Rotation monitoring				In-process measuring	Controller enable
DBB55		Software limit positions disabled		Enable input disabled	Retrig. ref. point	Length measurement		
DBB56	Reserved							
DBB57		Rescind setting of actual value	Restart		Autom. block return	Autom. block advance	Delete residual distance	Activate MD
DBB58	Set actual value	Set reference point		On-the-fly MDI block	MDI block	Setpoint for incremental dimension	Frequency levels 1, 2	Speed levels 1, 2
DBB59	Teach-In	Request application data	Program selection	Digital outputs	Modify parameters/data		Zero offset	On-the-fly setting of actual value
DBB60 to DBB61	Reserved							
DBB62	Data error read	Operator/traversing error read	Operating error read	Service data	Actual value block change	Next NC block	Active NC block	Basic operating data
DBB63	Read measured values	Application data	Additional operating data	Dig. inputs/outputs	Parameter/data			
DBB64 bis DBB65	Reserved							
Processing status of POS_CTRL								
DBW66	Error code (communications error) of the last job request/transfer (data type: INT)							
DBB68					Read request not possible	Read job active	Write request not possible	Write job active
DBB69							Reset status/error	

Table 6-11 User data block (AW-DB), continued

AW-DB FM 353								
Byte	Bit 7	Bit 6	Bit 5	Bit 4	Bit 3	Bit 2	Bit 1	Bit 0
Diagnostic data for the FM, read out with POS_DIAG								
DBB70		Module not initialized			Ext. chan. err. (DBB78)	External error	Int./HW err. (DBB 72, 73)	Module/group fault
DBB71				Channel info available	Module type classes (08H)			
DBB72				Int. module supply volt. failed	Watchdog triggered		Comm. error (K bus)	
DBB73		Process int. lost			RAM error	FEPROM error		
DBB74	FM pos. ID (74H)							
DBB75	Length of diagnostic information (16)							
DBB76	Number of channels (1)							
DBB77								Channel error vector
DBB78	Operating error							
DBB79 to DBB85	Reserved							
Error code after error message "Operating error" (is read if 'operating error' is set after calling the POS_DIAG block)								
DBB86	Error number (DS 164) – Detail event class							
DBB87	Error number (DS 164) – Detail event number							
DBB88 to DBB89	Reserved							
Error code following flagging of "Operator/traversing error"								
DBB90	Error number (DS 162) – Detail event class							
DBB91	Error number (DS 162) – Detail event number							
DBB92 to DBB93	Reserved							

Table 6-11 User data block (AW-DB), continued

AW-DB		FM 353						
Byte	Bit 7	Bit 6	Bit 5	Bit 4	Bit 3	Bit 2	Bit 1	Bit 0
Error code following flagging of "Data error"								
DBB94	Error number (DS163) – Detail event class							
DBB95	Error number (DS163) – Detail event number							
DBW96	Error code for the POS_DIAG block (return code SFC 51) (Data type: INT)							
DBW98	Error code for the POS_MSRM block (return code SFC 59) (Data type: INT)							
Data for the requests								
Zero offset								
DBD140	Data type: DINT							
Set actual value								
DBD144	Data type: DINT							
On-the-fly setting of actual value								
DBD148	Data type: DINT							
Set reference point								
DBD152	Data type: DINT							
Setpoint for incremental dimension								
DBD156								
Speed levels 1 and 2								
DBD160	Speed level 1							
DBD164	Speed level 2							
Frequency levels 1 and 2								
DBD168	Frequency level 1							
DBD172	Frequency level 2							

Table 6-11 User data block (AW-DB), continued

AW-DB		FM 353						
Byte	Bit 7	Bit 6	Bit 5	Bit 4	Bit 3	Bit 2	Bit 1	Bit 0
MDI block								
DBB176 to DBB177	Reserved							
DBB178				Position/ dwell			G function group 2 1	
DBB179					M function group 3 2 1			Speed
DBB180	G function no. of group 1							
DBB181	G function no. of group 2							
DBB182 bis DBB183	Reserved							
DBB184	Value for position/dwell (data type DINT)							
DBB188	Value for speed (data type DINT)							
DBB192	M function no. of group 1							
DBB193	M function no. of group 2							
DBB194	M function no. of group 3							
DBB195	Reserved							
Modify parameter/data or request reading of relevant data								
DBB196	DB type							
DBB197	Number							
DBB198	Quantity							
DBB199	Request							
DBB200 to DBB219	Data array, structure/data type of Write data as per bytes 1 to 4 of this structure (e.g. a program block or max. 5 MD items)							
Digital inputs/outputs								
DBB220					Digital input 3 2 1 0			
DBB221					Digital output 3 2 1 0			
On-the-fly MDI block								
DBB222 to DBB223	Reserved							
DBB224				Position/ dwell			G function group 2 1	
DBB225					M function group 3 2 1			Speed
DBB226	G function no. of group 1							

Table 6-11 User data block (AW-DB), continued

AW-DB		FM 353						
Byte	Bit 7	Bit 6	Bit 5	Bit 4	Bit 3	Bit 2	Bit 1	Bit 0
DBB227	G function no. of group 2							
DBB228 to DBB229	Reserved							
DBD230	Value for position/dwell (data type DINT)							
DBD234	Value for speed (data type DINT)							
DBB238	M function no. of group 1							
DBB239	M function no. of group 2							
DBB240	M function no. of group 3							
DBB241	Reserved							
Program selection								
DBB242	Program number							
DBB243	Block number							
DBB244	Direction of processing							
DBB245	Reserved							
Request for application data								
DBB246	Application data 1							
DBB247	Application data 2							
DBB248	Application data 3							
DBB249	Application data 4							
Teach-in								
DBB250	Program number							
DBB251	Block number							
DBB252 to DBB309	Reserved							
Data read as per request								
Basic operating data								
DBD310	Actual position (data type DINT)							
DBD314	Actual speed							
DBD318	Residual distance (data type DINT)							
DBD322	Setpoint position (data type DINT)							
DBD326	Sum of active coordinate offset, tool offset, zero offset (data type DINT)							
DBD330	Rotational speed							
DBD334 to DBD338	Reserved							

Table 6-11 User data block (AW-DB), continued

AW-DB		FM 353						
Byte	Bit 7	Bit 6	Bit 5	Bit 4	Bit 3	Bit 2	Bit 1	Bit 0
Active NC block								
DBB342	Program number							
DBB343	Block number							
DBB344	Block skip	UP call	No. of UP calls	Position/dwell		G function group		
						3	2	1
DBB345				Tool offset	M function group			Speed
					3	2	1	
DBB346	G function no. of group 1							
DBB347	G function no. of group 2							
DBB348	G function no. of group 3							
DBB349	Reserved							
DBD350	Value for position/dwell (data type DINT)							
DBD354	Value for speed (data type DINT)							
DBB358	M function no. of group 1							
DBB359	M function no. of group 2							
DBB360	M function no. of group 3							
DBB361	Tool offset no.							
Next NC block								
DBB362	Program number							
DBB363	Block number							
DBB364	Block skip	UP call	No. of UP calls	Position/dwell		G function group		
						3	2	1
DBB365				Tool offset	M function group			Speed
					3	2	1	
DBB366	G function no. of group 1							
DBB367	G function no. of group 2							
DBB368	G function no. of group 3							
DBB369	Reserved							
DBD370	Value for position/dwell (data type DINT)							
DBD374	Value for speed (data type DINT)							
DBB378	M function no. of group 1							
DBB379	M function no. of group 2							
DBB380	M function no. of group 3							
DBB381	Tool offset no.							

Table 6-11 User data block (AW-DB), continued

AW-DB		FM 353						
Byte	Bit 7	Bit 6	Bit 5	Bit 4	Bit 3	Bit 2	Bit 1	Bit 0
Application data								
DBD382	Application data 1 (data type: DINT)							
DBD386	Application data 2 (data type: DINT)							
DBD390	Application data 3 (data type: DINT)							
DBD394	Application data 4 (data type: DINT)							
Actual value block change								
DBD398	Data type DINT							
Service data								
DBD402	Frequency output value (data type DINT)							
DBD406	Pulse output counter (data type DINT)							
DBD410	Reserved							
DBD414	Reserved							
DBD418	Difference between setpoint and actual position (data type DINT)							
DBD422	Reserved							
DBD426	Switch adjustment (data type DINT)							
DBD430	Reserved							
Additional production data								
DBB434	Override							
DBB435	NC traversing program no.							
DBB436	NC block no.							
DBB437	UP call counter							
DBB438	Active G90/91							
DBB439	Active G60/64							
DBB440	Active G43/44							
DBB441	Active D number							
DBB442							Speed limit	
DBB443					Accelera- tion/decel- eration value lim- ited		Frequency value for accelera- tion limited	Start/stop frequency limited
DBB444 to DBB445	Reserved							
Parameter/data								
DBB446	DB type (MD, incremental dimension or traversing program)							
DBB447	Number							
DBB448	Quantity							
DBB449	Request							

Table 6-11 User data block (AW-DB), continued

AW-DB		FM 353						
Byte	Bit 7	Bit 6	Bit 5	Bit 4	Bit 3	Bit 2	Bit 1	Bit 0
DBB450 to DBB469	Array, structure/data type according to data, to be read as per bytes 1 to 4 of this structure (e.g. a program record or max. 5 MD items)							
DBB470 to DBB485	Reserved							
Measured values								
Measured values as per POS_MSVM call								
DBD486	Initial value or in-process measured value (data type DINT)							
DBD490	Final value (data type DINT)							
DBD494	Measured length value							
Array for operator control/monitoring								
Operator control and monitoring								
DBB498	Frequency levels transferred	Speed levels transferred	Increm. dim. transferred	Teach-in transferred	Prog. sel. transferred	MDI block transferred	Read MD	Write MD
DBB499	Operator/traversing error	Data error	Diagnostic interrupt			Zero offset transferred	Set actual value transferred	MDI block transferred on-the-fly
DBW500	MD number							
DBD502	MD value (data type DINT)							
DBB506	Incremental dimension number							
DBB507	Reserved							
DBW508	Display number							
DBW510	Keyboard code							
DBW512	Reserved							
Operating mode selection								
DBB514		Jog mode	Auto mode	Auto/single block mode	MDI	Incremental mode (relative)	Approach to reference point	Open-loop control mode
DBB515	Acknowledge diagnostic interrupt	Acknowledge error						

Note

For the symbolic signal designations, please refer to the “FMSTSV_L” library, UDT 1 block, or to the “FM353_354” library, DB 1 (IFFM_CTRL).

6.7 Sample applications

Overview

This chapter provides information on the following:

- Basic example for setting the operating mode
- Example 1: Moving axes in “JOG mode” and “Approach to reference point mode”
- Example 2: Traversing an MD block
- Example 3: “Automatic” mode with program selection
- Example 4: Technology example for embedding OPs

General remarks

The installation of the FM 353 configuration package includes the following sample projects:

- “zDt13_02_FM353_EX” ([STEP7 directory]\EXAMPLES\zDt13_02) for application examples for the “FMSTSV_L” block library
- “zDt13_03_FM353_EX” ([STEP7 directory]\EXAMPLES\zDt13_03) for application examples for the “FM353_354” block library

The relevant technological functions (POS_CTRL, POS_DIAG, POS_INIT) are called in the OB 1, OB 82 and OB 100 blocks. DB 100 (DBEX) contains the relevant user signals/user data for all application examples.

Each example is programmed as a block (e.g., example 1 = FC 101, etc.). In The basic example (FC 100) is always necessary for the examples 1 to 3; it sets the relevant modes and copies the data between DB 1 and DB 100.

The examples 1 to 3 are interdependent. They are technologically simple examples which you can expand to suit your particular needs. To be able to use the functions provided by the examples 1 to 3, call the relevant examples in OB 1 analogous to example 1.

OB 1 contains an example after the call of POS_CTRL how the evaluation of the reported errors of the POS_CTRL could be programmed. You can expand this error evaluation accordingly if you want.

Example 4 requires the **OB_example4** source file specified in the source folder to be compiled. Since this is an application example for use of an OP, only example 4 should be called in OB 1, as not to overwrite data.

Note

In the examples, the axes do not traverse in simulation mode!

Because “DBEX” is a retentive DB, it is initialized in the start/restart routine (OB 100). If this is not required, simply delete the initialization section of OB 100 (network “DBEX Initialization”).

Basic example for setting the operating mode

This example is always required for sample applications 1 to 3.

Open the “zDt13_02_FM353_EX” or the “zDt13_03_FM353_EX” example project in the SIMATIC Manager with **File > Open... > Projects**. The block for this example is FC 100.

You will find the signals in “DBEX”.

This example must always be called. It sets the operating modes according to the user’s specifications, evaluates the mode status signals, and displays the current mode. The checkback signals required for the examples will be copied into “DBEX”.

In order to use the “Jog” or “Reference point approach” mode in Example 1, the user has to set the relevant mode code in byte MODE_IN of “DBEX” (01 for “Jog”, 03 for “Reference point approach”). When “Jog” mode is selected, mode parameter 01 (MODE_TYPE) is additionally set for activating speed level 1 in “Jog” mode.

Mode	Code
Jog	01
Reference point approach	03
MDI	06
Auto	08

In Example 2, you must set “MDI” mode (mode coded in byte MODE_IN = 06).

In Example 3, you must set “Auto” mode (mode coded in byte MODE_IN = 08).

The active mode is displayed in byte MODE_OUT in the relevant code.

To restart the module (e.g. after diagnostic interrupt), bit RESET_AX must be set in “DBEX”. The example will then set bit RESET_AX in “AW-DB”. A restart will be initiated and bit RESET_AX reset in “DBEX”.

In order to work with the following examples, you must set the mode required for each.

Example 1

Open the example project. The block used for this example is FC 101.

The signals are in "DBEX". The signals relevant for Example 1 only are in structure "EX1".

The Drive Enable and the Controller Enable for the axis are set in "DBEX" (OB 100: DRV_EN = TRUE, SERVO_EN = TRUE) and are transferred to the interface (AW_DB) in Example 1.

In order for the example to function, you must first set either "Jog" mode (mode code 01) or "Reference point approach" mode (mode code 03) in byte MODE_IN of the "DBEX". The respective mode checkback signal is flagged in byte MODE_OUT.

The traversing movements are shown in bits "GO_M" = TRUE (traverse -axis 1) or "GO_P" = TRUE (traverse + axis 1).

"Jog" mode active:

Once a mode has become active, the Write request "VLEV_EN" (AW-DB, transfer speed level 1, 2) is executed once. If you want to transfer it again, you must either reset the "VLEV_D" bit (status/checkback signal from the request) or set the "JOBRESET" (reset status/error) in DB_FM.

If you set bit "DIR_M" (minus direction) or bit "DIR_P" (plus direction) to TRUE in "DBEX", the axis is moved in either a negative or positive direction.

"Reference point approach" mode active:

When you set the "START" bit to TRUE, the axis is moved in a negative or positive direction (depending on the machine data initialization) until the reference point is located. If the reference point approach was successful, the axis is synchronized (SYNC=TRUE).

If an operator or traverse error occurred, this is flagged by bit "OT_ERR" = TRUE. An error can be acknowledged by setting bit "OT_ERR_A" to TRUE.

Note:

Variable table 1, which contains all the relevant signals for monitoring and controlling Example 1 ("control and monitor variable" tool), is located in the "Blocks" directory.

Example 2

Open the example project. The block used for this example is FC 102.

The signals are in "DBEX". The signals relevant for Example 2 only are in structure "EX2".

The Drive Enable and the Controller Enable for the axis are set in "DBEX" (OB 100: DRV_EN = TRUE, SERVO_EN = TRUE), and are transferred to the interface (AW-DB) in Example 2.

In order for the example to function, you must set the "MDI" mode. Enter "MDI" mode (mode code 06) in the MODE_IN byte of "DBEX". The relevant mode check-back signal is flagged in byte MODE_OUT.

Once the mode has been successfully set, a default MDI block is automatically transferred to the module (MDI network) when Write request "MDI_EN" has been set in "AW-DB" (transfer MDI block). This block can be changed in dependence on the system and the request. If it is to be retransferred, you either have to reset the "MDI_D" bit in "AW-DB" (status/checkback signal for request) or set bit "JOBRESET" (reset status/error).

Set the "START" bit in "DBEX" to TRUE in the "EX2" structure. The activated MDI block is started on the condition that the axis is synchronized and has a Start Enable. Then the "START" bit is reset. The MDI block cannot be restarted until the start enable is again available.

The block can be stopped by setting the "STOP" bit.

Only when the "STOP" bit has been reset to FALSE (and the "START" bit to TRUE) is a restart possible.

If an operator error or traversing error occurs, it is flagged by the "OT_ERR" bit (the bit is set to TRUE). The error can be acknowledged by setting the "OT_ERR_A" bit to TRUE.

Note:

Variable table 2, which contains all the relevant signals for monitoring and controlling Example 2 ("control and monitor variable" tool), is located in the "Blocks" directory.

Example 3

Open the example project. The block used for this example is FC 103.

The signals are in "DBEX". The signals relevant for Example 3 only are in structure "EX3".

The program to be selected in the Example has the program number "10". This program number is entered in Example 3.

The Read Enable, the Drive Enable, and the Controller Enable for the axis are set in "DBEX" (OB 100: READ_EN = TRUE, DRV_EN=TRUE, SERVO_EN=TRUE), and are transferred to the interface (AW-DB) in Example 3.

Prerequisite for successful program selection is the availability of that program in the FM.

In order for the example to function, you must set "Auto" mode. Set the "AUTO" mode (mode code 08) in byte MODE_IN of "DBEX". The relevant mode checkback signal is flagged in byte MODE-OUT.

Following successful mode selection, the program with the number "10" is automatically selected by setting Write request "PROGS_EN" in "AW-DB".

Set the "START" bit in "DBEX" to TRUE in structure "EX3". The selected program is started, assuming that the axis is synchronized and has a Start Enable. Then the "START" bit will be reset.

The program can be stopped by setting the "STOP" bit. It can be restarted by resetting the "STOP" bit to FALSE (and the "START" bit to TRUE).

If an operator error or traversing error occurs, it is flagged in the "OT_ERR" bit (the bit is then TRUE). The error can be acknowledged by setting bit "OT_ERR_A" to TRUE.

Note:

Variable table 3, which contains all the relevant signals for monitoring and controlling Example 3 ("control and monitor variable" tool), is located in the "Blocks" directory.

Example 4

Open the example project. The block used for this example is FC 104.

Note: If you call the example 4 in OB 1, then please do not call the examples 1 to 3 at the same time; otherwise, data would be overwritten.

In this example, the HMI interface signals for the data range from DBB 498 through DBB 515 are transferred to the interface area for the control signals, e.g. the modes (see Section 8.2).

You can trigger write and read jobs by assigning the data fields to be transferred the appropriate parameters and data.

For example, if you select the machine data screen PIC_763, you can write an MD using the "set" softkey (SK) and read an MD using the "read" softkey (SK).

Once you have selected the mode screen PIC_75 on the operator panel and selected the appropriate mode SK, the selected mode will be accepted into the control signals of the interface, and the appropriate mode will be set.

If you select the diagnostic screen PIC_77, you can acknowledge an error by pressing the "Quit" SK or acknowledge a diagnostic alarm by pressing the "Res" SK.

In this way, all interface signals which can be activated by the OP are requested. You can assign default values to all data fields and transmit trigger pulses for the jobs to be executed.

Structure of “DBEX” (DB 100)

```

DATA_BLOCK “DBEX”
STRUCT
    // *** General signals ***
    ERR_CODE_INIT : INT; // Error code for POS_INIT
    ERR_CODE_CTRL : INT; // Error code for POS_CTRL
    ERR_CODE_DIAG : INT; // Error code for POS_DIAG
    OVERRIDE      : BYTE; // Override
    MODE_IN       : BYTE; // Mode setting (coded)
    MODE_OUT      : BYTE; // Mode setting (coded)
    DRV_EN        : BOOL; // Drive Enable
    SERVO_EN      : BOOL; // Controller Enable
    OT_ERR_A      : BOOL; // Acknowledgement for operator/traversing error
    RESET_AX     : BOOL; // Restart
    DIAG_RD       : BOOL; // Start of POS_DIAG
    PARA         : BOOL; // Initialized
    SYNC         : BOOL; // Synchronized
    START_EN      : BOOL; // Start Enable
    POS_ROD       : BOOL; // Position reached, Stop
    WORKING       : BOOL; // Execution in progress
    GO_M         : BOOL; // Traverse in negative direction
    GO_P         : BOOL; // Traverse in positive direction
    OT_ERR        : BOOL; // Operator-/traversing error
    DATA_ERR     : BOOL; // Data error
    INIT_ERR      : BOOL; // Error in POS_INIT
    DIAG_ERR      : BOOL; // Error in POS_DIAG
    MINUS1       : BOOL; // “MINUS1” error in POS_CTRL
    MINUS2       : BOOL; // “MINUS2” error in POS_CTRL
    MINUS3       : BOOL; // “MINUS3” error in POS_CTRL
    EX1: STRUCT
        // *** Signals for EXAMPLE 1 ***
        DIR_M      : BOOL; // Negative direction
        DIR_P      : BOOL; // Positive direction
        START      : BOOL; // Start
        STOP       : BOOL; // Stop
    END_STRUCT;
    EX2: STRUCT
        // *** Signals for EXAMPLE 2 ***
        START      : BOOL; // Start
        STOP       : BOOL; // Stop
    END_STRUCT;
    EX3: STRUCT
        // *** Signals for EXAMPLE 3 ***
        START      : BOOL; // Start
        STOP       : BOOL; // Stop
        READ_EN    : BOOL; // Read Enable
    END_STRUCT;
END_STRUCT
BEGIN
END_DATA_BLOCK

```

6.8 Error list, system messages (CPU)

The Table below lists some of the errors which occur during data transfer with the internal SFC/SFBs (RET_VAL in SFCs 51, 58 and 59 and status messages (bytes 2 and 3), SFB 52/53, system messages) (see Reference Manual *System Software for S7-300/400; System and Standard Functions*).

Table 6-12 Error list

Error Code (AW-DB, DBW66)			Description
HEX	DEC	INT	
0	0	0	No errors
8082	32898	-32638	SZL_ID invalid or not in CPU
8085	32901	-32635	Information currently unavailable (caused by system)
80A0	32928	-32608	Negative acknowledgement when reading from module. Module removed during Read operation or module defective.
80A1	32929	-32607	Negative acknowledgement while writing to module. Module removed during Write operation or module defective.
80A2	32930	-32606	DP protocol error in layer 2 (data transfer over Profibus-DP interrupted, e.g. due to wirebreak, missing terminator, parameterization error, etc.)
80A3	32931	-32605	<ul style="list-style-type: none"> • PROFIBUS: DP protocol error in layer 2 (data transfer over Profibus-DP interrupted, e.g. due to wirebreak, missing terminator, parameterization error, etc.) • PROFINET IO: General CM error
80A4	32932	-32604	Communication problem on K bus
80A7	32935	-63601	DP slave or module is busy
80A9	32937	-63599	This function is not supported by DP slave or by the module.
80AA to 80AF	32938 to 32943	-32598 to -32593	DP slave or module is reporting a manufacturer-specific error in the evaluation. For specifying the error, please refer to the Manufacturer Documentation of the DP slave or of the module.
80B0	32944	-32592	The module does not know this data record.
80B1	32945	-32591	Invalid length specification in the RECORD parameter
80B2	32946	-32590	The configured slot is not occupied.
80B3	32947	-32589	Actual module type not the same as setpoint module type
80B5	32949	-32587	DP slave or module not ready
80B6	32950	-32586	Access to DP slave or module denied
80C0	32960	-32576	Module does not yet have the data to be read available
80C1	32961	-32575	Data from an identical Write job have not yet been processed on the module
80C2	32962	-32574	Module is currently servicing the maximum possible number of requests
80C3	32963	-32573	Needed resources (such as memory, etc.) are currently in use

Table 6-12 Error list, continued

Error Code (AW-DB, DBW66)			Description
HEX	DEC	INT	
80C4	32964	-32572	Communication error; repeat the job.
80C5	32965	-32571	Distributed I/O not available
80C7	32966	-32570	Job aborted due to restart (warm restart) or cold restart of DP master
8522	34082	-31454	DB too short; the data cannot be read out of the DB (Write request)
8532	34098	-31438	DB no. out of user area
853A	34106	-31430	DB does not exist (Write request)
8544	34116	-31420	Error on the n-th ($n > 1$) attempt to read a DB following the occurrence of an error (Write request)
8723	34595	-30941	DB too short. The data cannot be written to the DB (Read request).
8730	34608	-30928	DB write-protected in the CPU. Data cannot be written to the DB (Read request).
8732	34610	-30926	DB no. out of user area
873A	34618	-30918	DB does not exist (Read request)
8745	34629	-30907	Error on the n-th attempt ($n > 1$) to write to a DB following the occurrence of an error (Read request)
The errors 80A2 to 80A7, as well as 80Cx are temporary, i.e. it is possible that they are eliminated without your intervention after a certain time of waiting. Messages in the form 7xxx indicate temporary communication states.			

6.9 Technical specifications

Memory allocation

The Table below provides an overview of the memory allocation for the blocks and the user data block (AW-DB). All values are rounded.

Table 6-13 Memory requirements for the blocks and user data block

No.	Block	Block in bytes Loading buffer	MC7 code in bytes	Local data in bytes
0	POS_INIT	250	142	4
1	POS_CTRL	3,394	2,964	22
2	POS_DIAG	310	186	46
3	POS_MSRM	286	176	20
4	AW-DB	1,884	516	–

Table 6-14 Memory mapping of the blocks and of the user data block AW-DB, “FM353_354” library

No.	Block	Block in bytes Loading buffer	MC7 code in bytes	Local data in bytes
0	POS_INIT	250	142	4
1	POS_CTRL	4,966	3,198	34
2	POS_DIAG	310	186	46
3	POS_MSRM	380	242	32
4	AW-DB	2,012	576	–

Processing times for the blocks taking the following example system

The specified times are rounded.

Structure: CPU 315-2DP, FM 353 in the simulation mode

User cycle time: approx. 5 ms

FM cycle: 2 ms

Table 6-15 Processing times for the blocks

Block	Transfer	Cycle 1	Cycle 2	Cycle 3
POS_CTRL	Write control/status signals without data	1.3 ms	–	–
	Write control/status signals with data	1.5 ms	3.2 ms	1.5 ms
	Read control/status signals with data	3.6 ms	–	–

Table 6-15 Processing times for the blocks, continued

Block	Transfer	Cycle 1	Cycle 2	Cycle 3
POS_DIAG	Read process and diagnostic data	3.2 ms	–	–
POS_MSRM	Read measured values	3.6 ms		

Processing times for the blocks when used in a distributed configuration PROFIBUS DP), taking the following example

The specified times are rounded.

Structure: CPU 315-2DP, IM 153-2, FM 353 in the simulation mode

User cycle time: 5 ms

FM cycle: 2 ms

Baud rate: 1.5 MB

Table 6-16 Processing times for distributed blocks

No.	Block	System data transfer	Transfer time in the range from ... to	Average transfer time
0	POS_CTRL	Control/checkback signals	1.1...1.5 ms	1.3 ms
1	POS_CTRL	Write request	30...40 ms	35 ms
2	POS_CTRL	Read request	10...20 ms	15 ms
3	POS_DIAG	Read	2.1...2.7 ms	2.4 ms

Several cycles are required to read or write data via the relevant requests.

Response time for start signals to a distributed FM (PROFIBUS DP)

Table 6-17 Response times for start signals

From the view of the CPU: from calling the block	to	Response time in the range from ... to
Start "Jog"	Response at the output of the FM (axis traverses, incl. FM response time)	8...13 ms
Start "MDI"		10...15 ms



Starting up

7

Chapter Overview

Section	Section Header	Page
7.1	Installation and wiring	7-2
7.2	Initial values for testing and optimization	7-3
7.3	Testing and optimization	7-7

Overview

This Chapter introduces you to the user interface for testing and start-up, and provides check lists for starting up the positioning module. The checklists will help you:

- Check all steps until the module is running.
- Prevent malfunctions of the module once it is in operation.

You are guided through start-up of the machine axes.

7.1 Installation and wiring

Installation information

You can find information about how to install your module:

- In Chapter 3 of this manual
- In the manual *S7-300 Programmable Controller, Hardware and Installation*

Wiring information

You can find information about how to wire your module:

- In Chapter 4 of this manual
- In the manual *S7-300 Programmable Controller, Hardware and Installation*

Checklist

The checklist below will help you check important steps in the installation and parameterization of the FM 353 positioning module.

Table 7-1 Installation and wiring checklist

Step	Check	What to do:	OK
1	Slots	Plug the module into one of the suitable slots.	
2	Shielding	Check the shielding of the FM 353 positioning module: <ul style="list-style-type: none"> • To ensure proper shielding, the module must be screwed down firmly on the rail. • The shielding for shielded lines for digital I/O modules must be connected to the shielding terminal element. • The shielding for the setpoint cable should not be grounded on the drive-unit end. 	
3	Limit switches	Check the start/stop limit switches. The limit-switch connections must be connected to the power section. The start/stop limit switches should not be connected to the digital inputs.	
4	Parameterize	Make sure the FM 353 positioning module setup is consistent with the parameterization. Check in particular that the wiring of the digital I/O modules matches the machine data.	

7.2 Initial values for testing and optimization

Parameterization information

You can find information about parameterization:

- In Chapter 5 of this manual
- In the on-line help in “Parameterize FM 353”

Overview

The following overview display appears in the “Parameterize FM 353” tool:

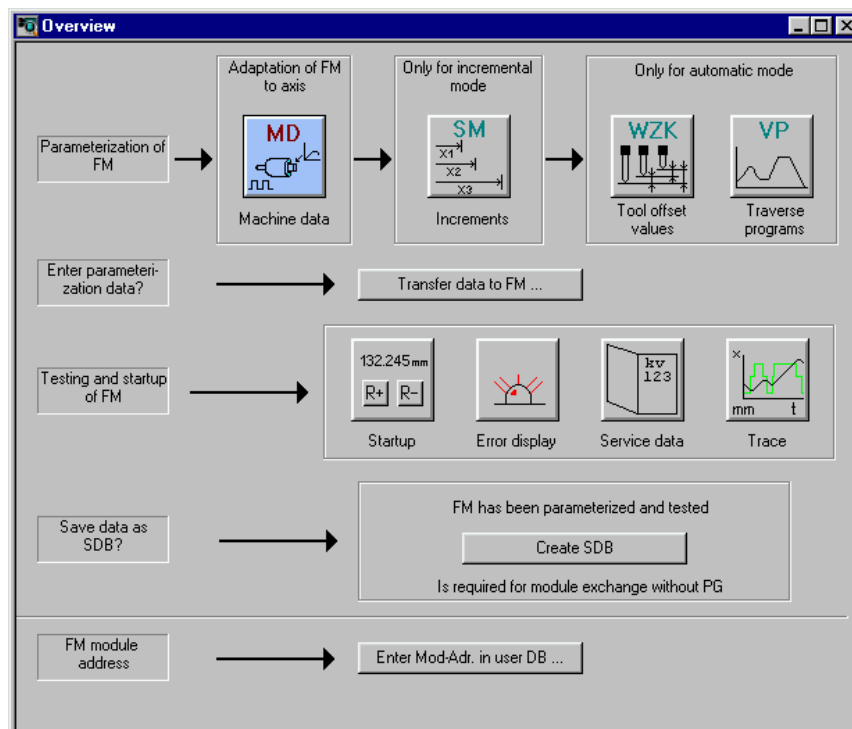

Fig. 7-1 Overview display for parameterization and start-up

You can return to this display at any point during parameterization by selecting the menu **View > Overview**.

As it is written to the FM 353, the DB-MD is checked for the input limits of the individual values and their interdependencies. It is then stored only if all values are allowed. Otherwise data error messages are displayed by way of the MPI. A defective DB will not be retained when the power is turned off.

Checklist

Despite the “acceptance” testing just mentioned, the ultimate responsibility for the accuracy of all machine data lies with the module user. So it is highly advisable to perform startup using the following checklist.

Table 7-2 Parameterization checklist

Step	Check	What to do:	OK
1	Machine data	<p>Set initial machine data contents</p> <p>As shown in Table 5-4 machine data are subdivided into configuration data (K) and setting data (E). K data indicates how the FM 353 is connected to the machine axis or CPU user program, and must therefore already be fully set up before startup begins. When specifying the MD13 (number of increments per motor revolution) for drives with adjustable increment number, select the one with which your maximum frequency (at maximum axis speed provided) reaches the next lowest value below the FM 353's maximum frequency of 200 kHz.</p> <p>E data is intended for changes during startup, and serves to optimize FM 353 response for the technological process of positioning.</p> <p>The values in Table 7-3 are recommended, and sometimes necessary, as initial settings.</p> <p>Initial machine data assignments for FM STEPDRIVE</p> <p>To help you start up your machine axis with FM STEPDRIVE and the SIMOSTEP motors, you will find the MD DBs for open-loop control mode in the directory [STEP7 directory]EXAMPLES\FM353\MD:</p> <ul style="list-style-type: none"> • SIMOSTEP 2 si02_353.md • SIMOSTEP 4 si04_353.md • SIMOSTEP 6 si06_353.md • SIMOSTEP 10 si10_353.md • SIMOSTEP 15 si15_353.md <p>These machine MD DBs achieve optimum operation assuming</p> $I_{\text{Load}} = I_{\text{Mot}}$ $M_{\text{Load}} = 0.1 \cdot M_{\text{Rated}}$ $n_{\text{max}} = 2\,000 \text{ min}^{-1}$ <p>You must optimize the machine data in accordance with the physical and technological conditions of your machine axis.</p>	
2	Increments	<p>Increments are only needed for the “Relative incremental” mode. For the next part of the startup procedure it is helpful to set up an “Increments” data block (DB-SM) with the following values:</p> <p>Value 1 1 MSR Value 2 10 MSR Value 3 100 MSR Value 4 1,000 MSR Value 5 10,000 MSR</p> <p>with rotary axes:</p> <p>Value 6 1 rotary-axis cycle (MSR) MSR = measurement-system grid</p>	

Table 7-2 Parameterization checklist, continued

Step	Check	What to do:	OK
3	Tool offset data	Tool offset data is needed only for the "Automatic" mode and is not necessary for the startup described here. Generally, it is not needed until you start up the user program on the S7-300 CPU.	
4	Traversing programs	Traversing programs are needed only for the "Automatic" mode and are not necessary for the startup described here. Generally, it is not needed until you start up the user program on the S7-300 CPU.	
5	Create SDB \geq 1 000	When you have completed all start-up actions on the FM 353 and your plant, create, save and load SDB \geq 1 000 into the CPU/onto the memory card of the CPU. All the parameter data (DBs) of the FM 353 are stored in SDB \geq 1 000. This SDB allows you to replace the FM 353 module in the event of a fault, and to download the parameters without a programming device/PC.	

Note

The measurement system (MD7) must match the measurement system specified in the other DBs.

The measurement system raster (MSR) is the smallest distance unit in the active system of measurement.

If at some point you have failed to take this precaution:

1. Delete all data blocks (which do not match the measurement system) or clear the memory of the FM 353 completely.
2. Modify the other data blocks on the PG.
3. Reload the data blocks to the FM 353.

Initial contents of MD

The table below shows you what initial contents are recommended or required for the E machine data at startup of the machine axis.

Enter the machine data in the tab windows or in table format in accordance with the following table.

Table 7-3 Initial contents of machine data

MD (E)	Value	Explanation
5	0	FM 353 triggers no process interrupts
16	$-10^9 \dots +10^9$ [MSR]	Specified reference-point coordinates
21/22	$-10^9/+10^9$ [MSR]	Software limit switches inactive
27	0	Reference-point shift (incremental encoders only) should be entered for numerical readjustment of the reference point

Table 7-3 Initial contents of machine data, continued

MD (E)	Value	Explanation
28 ¹⁾	$0.2 \cdot v_{\max}$	20% of the maximum speed is the recommended initial value
29 ¹⁾	$0.1 \cdot v_{\max}$	10% of the maximum speed is the recommended initial value
30/31	0/0	Backlash compensation inactive
39		Start/Stop frequency from operating characteristic curve, see Section 7.3.2
40		Frequency value for acceleration switchover from operating characteristic curve, see Section 7.3.2
41		Maximum frequency from drive configuration
42 43 44 45		Acceleration values for powerup and braking from operating characteristic curve, see Section 7.3.2
46	100	Minimum idle time between two positioning cycles
47	100	Minimum traversing time at constant frequency
48	100	Boost duration, absolute
49	100	Boost duration, relative
50	100	Phase current travel
51	100	Phase current idle

1) v_{\max} can be calculated according to the following formula:

$$v_{\max} = f_{\max} \cdot 60 \text{ s/min} \cdot s_{\text{pulse}}$$

$$v_{\max} [\text{MSR/min}] = \text{MD41} [\text{Hz}] \cdot 60 \text{ s/min} \cdot \frac{(\text{MD11} + \text{MD12} \cdot 2^{-32}) [\text{MSR/U}]}{\text{MD13} [\text{increments/rev}]}$$

7.3 Testing and optimization

Testing and optimization information

Once you have installed, wired and parameterized the unit, you can test and optimize your FM 353 positioning module. Testing and optimization can be performed with the aid of the testing and start-up interface with or without the user program.

You can also test individual modes and their traversing programs, and view and debug them during execution.

There are two ways of operating the FM:

- **CPU is in “STOP”, test without user program**
- **CPU is in “RUN”, test with user program**

You can monitor the interface between the FM and the user program. You can also control the program from the start-up user interface when control signal [TFB] (TEST_EN) is enabled in the user program.

This interface is installed with “Parameterize FM 353”. Once the FM 353 has been parameterized, you can call it up by selecting the menu **Test > Startup** or by selecting from the overview display.

When you call up this menu the following screen appears:

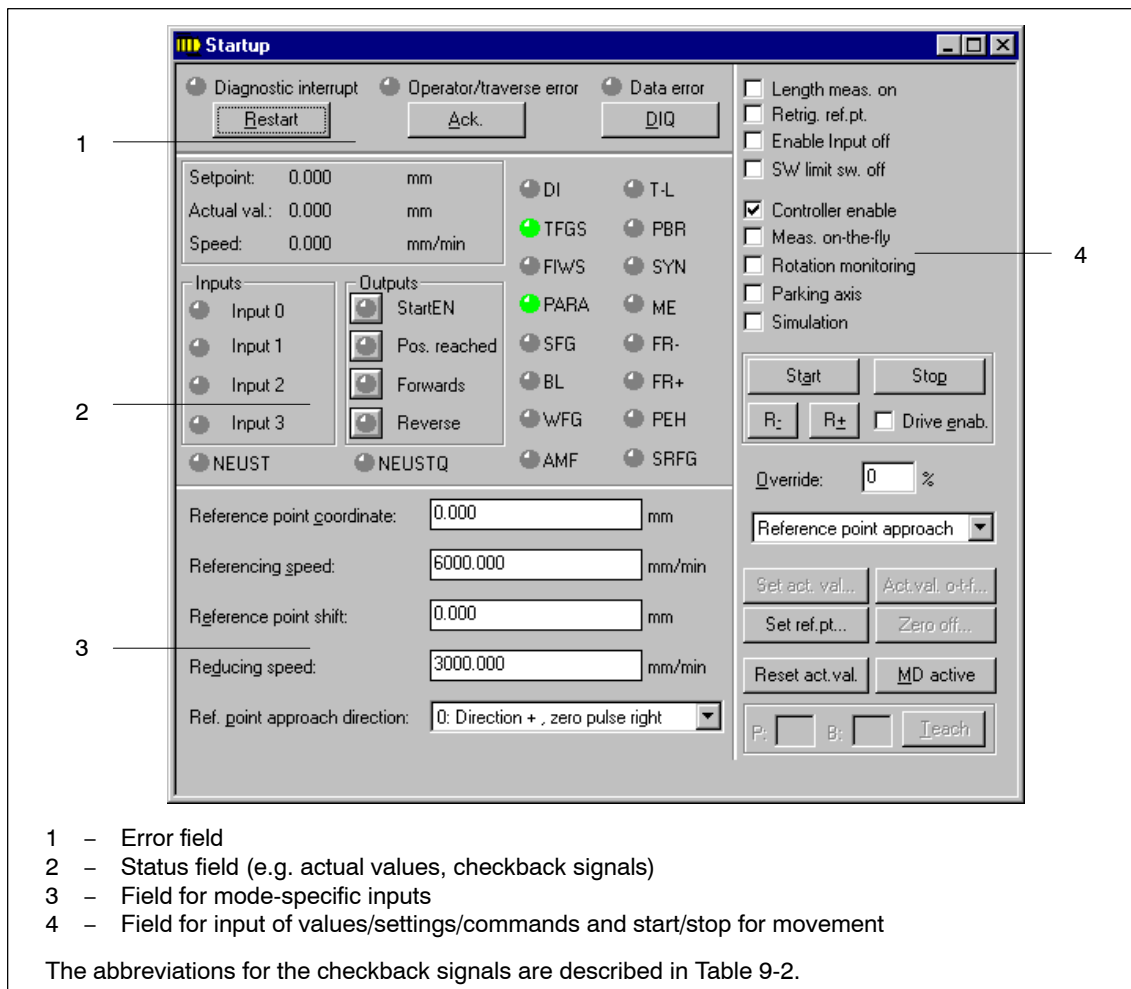

Fig. 7-2 Startup interface (e.g. for "Reference-point approach" mode)

Note

- Select a mode
- Turn simulation on (if you want an operating case)
- Servo enable
- Drive enable
- Override 1 – 100%

You can operate the “R+” and “R-” buttons in the “jogging” mode as follows:

1. Select “R+” or “R-” with the mouse
2. Press the space bar

You can operate “Start” and “Stop” with the mouse, or with the space bar if you have already selected the button.

The digital outputs are not set in the “Stop” status of the CPU.

When you call up the following button, you will get dialog windows:

- set actual value
 - set actual value on-the-fly
 - set reference point
 - zero offset
-

**Warning**

If you move the axis directly (without simulation), for safety's sake make sure you can switch off the hardware if a hazard arises.

Note

If you use the start-up user interface to operate the FM 353 when the CPU is in “STOP”, and then switch the CPU to “RUN” and then immediately switch to the start-up interface in your user program by means of the [TFB] (TEST_EN) signals (e.g. if example application 3 is included in the user program), please note the following:

You must select the mode again from the start-up interface, or close the start-up interface and call it up again.

You can also call up the following screens:

The following display appears when you select **Test > Alarms**:

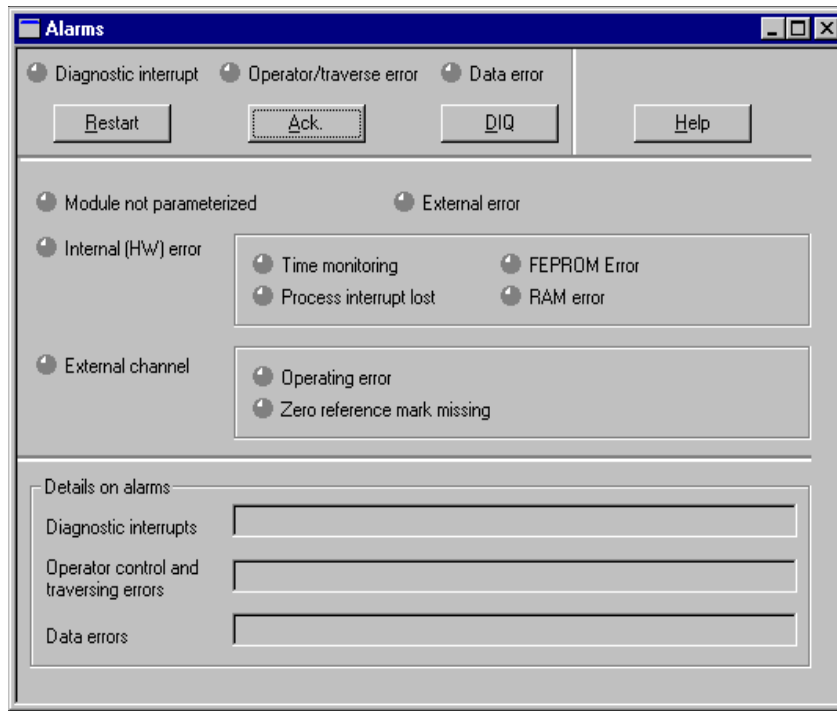

Fig. 7-3 Troubleshooting

The following display appears when you select **Test > Service data**:

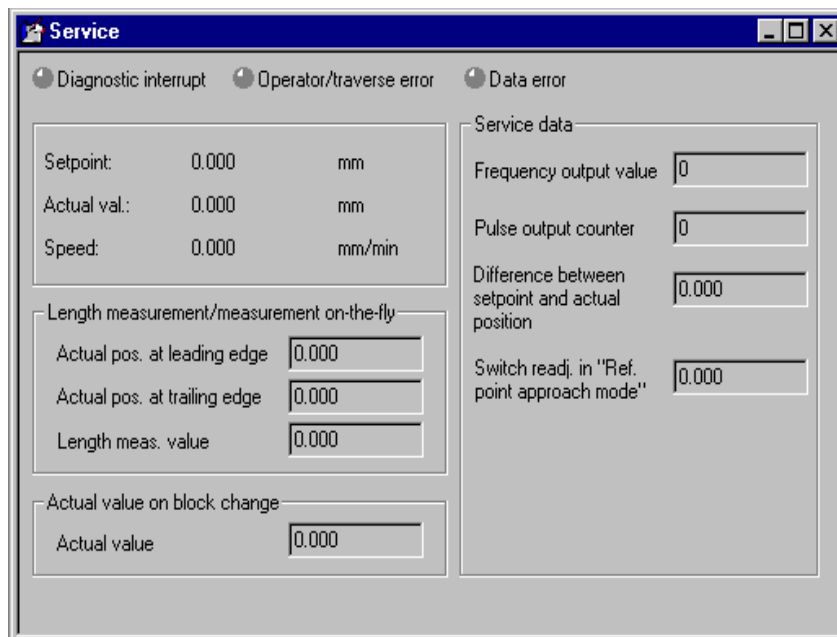

Fig. 7-4 Service data

The following display appears when you select **Test > Trace**:

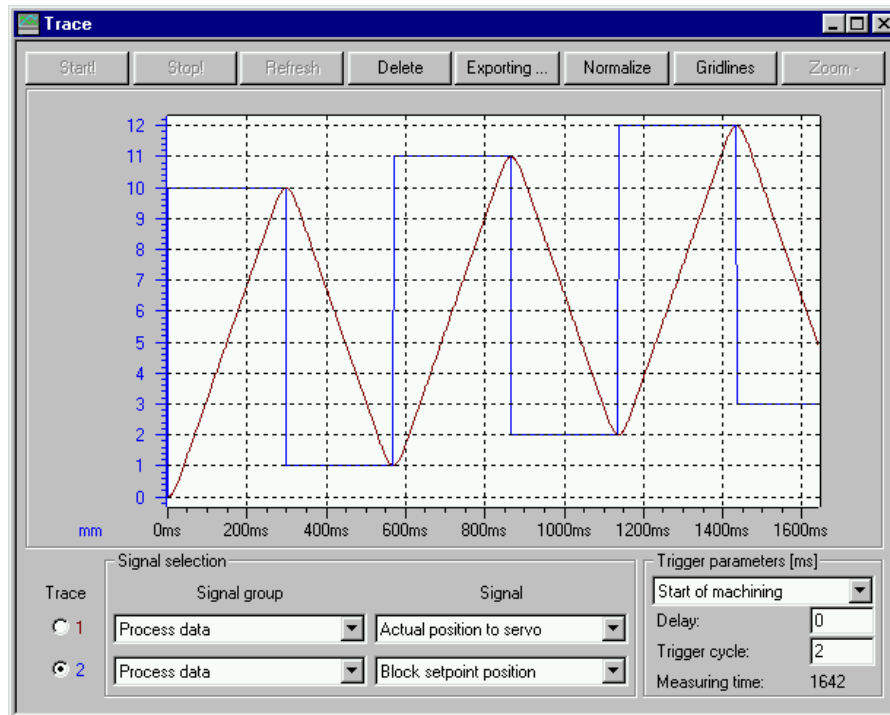

Fig. 7-5 Trace

Checklist

When starting up the machine axis, it is important to perform the following steps in the indicated sequence. Steps 1 to 5 are always necessary; the rest are optional, depending on your own application.

Table 7-4 Checklist - startup of machine axis

Step	Check	What to do?	Page	OK
1	Activation of machine data	See Section 7.3.1	7-13	
2	Evaluation of operating characteristic curves of the stepper motor	See Section 7.3.2	7-14	
3	Basic startup of stepper motor control	See Section 7.3.3	7-18	
4	Optimization of dynamic response	See Section 7.3.4	7-21	
5	Readjustment of reference point coordinates	See Section 7.3.5	7-24	
6	Activation of stepper motor diagnostics	See Section 7.3.6	7-25	
7	Activation of software limit switches and backlash compensation	See Section 7.3.7	7-26	

Note

In order for an axis to start, the start enable checkback signal must have been set.

If there is no start enable, this may be because:

- “Drive enable” is not set
 - “Stop” is set
 - “Operation in progress” is active
-

7.3.1 Activating the machine data

Overview

The checkback signal PARA notifies you that a DB-MD has been retained. This machine data is automatically activated at power-up. The module's positioning functions are ready to operate.

If no DB-MD is present as yet on the FM 353 when the control is switched on, the module can only communicate by way of the MPI interface. The control signals are not processed by the FM 353. Once an error-free DB-MD has been transferred, the machine data is automatically activated, PARA is set and the control signals are processed.

If the FM 353 is working with activated machine data, you can transfer a new data block or individual parameters in modified form to the module and, if the entire DB-MD is error-free, put the new or modified data into effect by means of the "Activate machine data" function provided that an operating mode is active (parameterizing tool "Start-up display").

The following approaches are possible:

- If only E data has been modified in the machine data record since the last activation, the equipment is activated with module status "Operation in progress" = 0, without interrupting the servo cycle. "SYN" is retained.
- If K data has also been modified in the machine data record since the last activation, activation takes place with module status "Operation in progress" = 0 by way of a cold restart of the servo, just as occurs for a power-up of the module. The instantaneous actual position is still displayed, but encoder pulses from incremental encoders might go unrecorded. "SYN" is reset.
- If the machine data record contains erroneous data at activation time, the function is rejected, with the "Machine data cannot be activated" error message (see Table 11-5, Class 2, No. 21).

7.3.2 Evaluating the characteristics of the stepper motor

Overview

Basically, the stepper motor is a highly dynamic drive motor which is capable of following setpoint assignments more or less free of following error. It is also capable of handling the transition between idle time and movement (and back) by way of the start/stop frequency at an extremely high rate of acceleration. This presupposes however, that the available motor torque at any given movement status, matches as a minimum, the torque necessary for executing the movement. In the following discussion, it is assumed that you are familiar with the necessary torque values for your particular application from the having conducted configuration of the drive. If necessary, refer to the formula or tabular material (e.g. Positec/Berger Lahr: [title translated: "Formulas + Computations for optimal stepper motor adjustment" [TN: available in English? If so, what is exact English title?] provided by the stepper drive manufacturers.

You can obtain optimal configuration of the speed profile for traversing movement when the speed-timing diagram, as shown in Figure 9-7, is well-defined.

You can determine the parameters for the speed profile, as shown in the following parameterization example, from the operating characteristic curves of the stepper motor you have in use. When doing this, please be sure to always allow a torque reserve of approx. 20%.

Procedure

Determining the available or necessary torque:

$$M_{\text{Motor}} = M_{\text{Load}} + M_{\text{Accelerations}}$$

Determining the present moments of inertia:

$$J_{\text{Load}} = J_{\text{external_rotational}} + J_{\text{external_translational}}$$
$$J_{\text{total}} = J_{\text{Motor}} + J_{\text{Load}}$$

Assumed values from the parameterization example:

$$M_{\text{Motor}} = 5 \text{ Nm}$$
$$M_{\text{Load}} = 0,6 \text{ Nm (assumption: constant at all rpms)}$$
$$J_{\text{Motor}} = 4 \text{ kg} \cdot \text{cm}^2$$
$$J_{\text{Load}} = 3 \text{ kg} \cdot \text{cm}^2$$
$$\text{MD13} = 500 \text{ increments per revolution}$$
$$f_{\text{max}} = 10 \text{ kHz}$$

Further definitions, e.g.:

acceleration values = deceleration values

Determining the machine data:

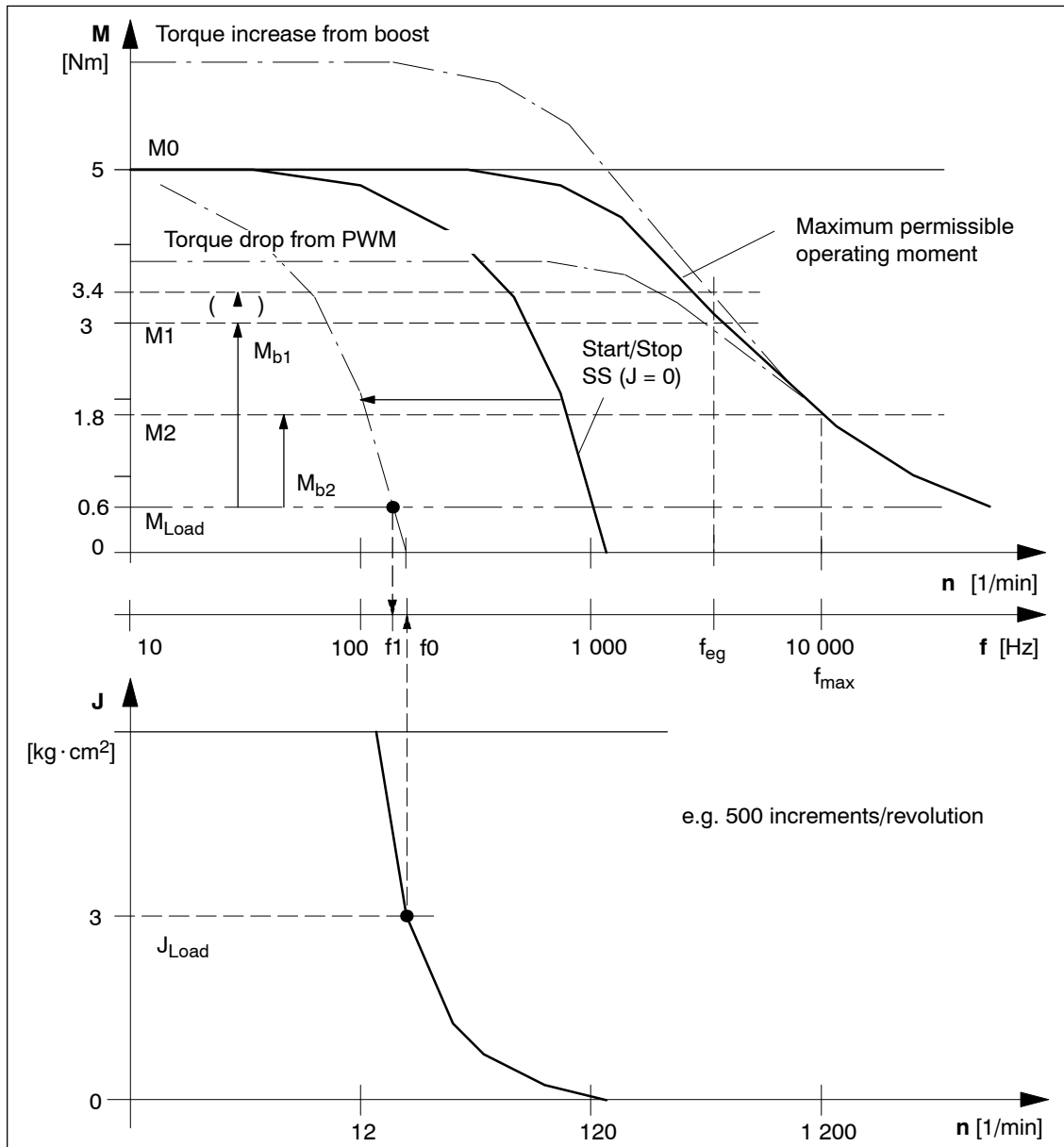

Fig. 7-6 Operating characteristic curve of the stepper motor

When you evaluate this example characteristic in accordance with the algorithm in Figure 7-7, you determine the following machine data:

MD39 = 100 Hz	Start/stop frequency
MD40 = 3 000 Hz	Frequency value f_{eg}
MD42 = 218 000 Hz/s	Acceleration 1 ($f \leq f_{eg}$)
MD43 = 109 000 Hz/s	Acceleration 2 ($f > f_{eg}$)
MD44 = 0	Deceleration 1 = acceleration 1
MD45 = 0	Deceleration 2 = acceleration 2

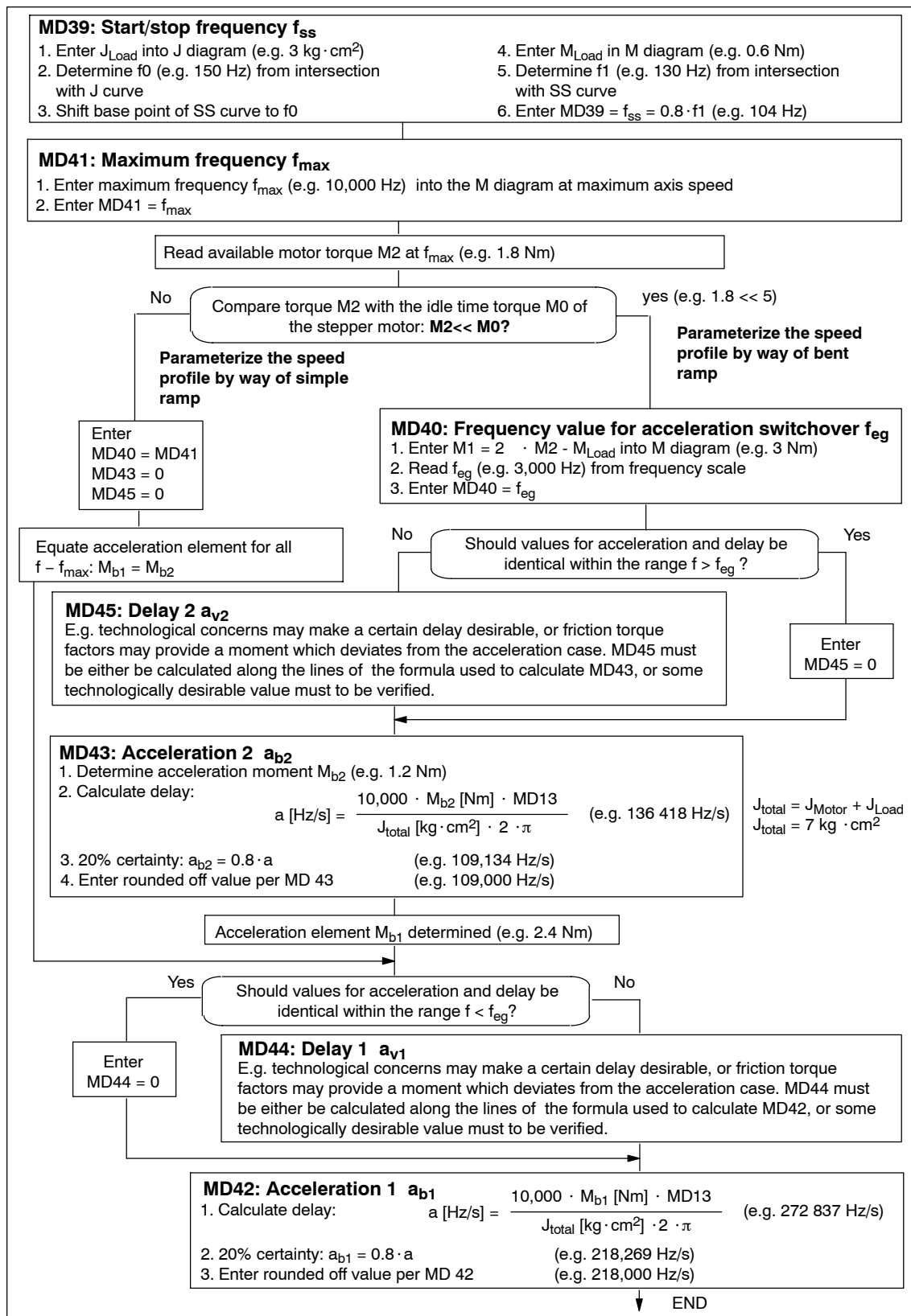

Fig. 7-7 Evaluation of operating characteristic curves

Notes

Notes regarding special boundary conditions:

- It is evident from the above example that the acceleration moment within the lower speed range is approximately twice the value of the same value at maximum speed. This results in optimally-timed positioning cycles. Of course, the acceleration switchover is freely selectable in accordance with certain technological criteria. In this case the result is the value of the available motor torque M_1 or M_{b1} according to the characteristic.
- In case your stepper drive features the “Current control through boost” function, you can count on the elevated curve for determining the acceleration moment. Any advantage from increased acceleration capability is realized from the moment curve only within the lower rpm range of the motor (e.g. $M_{b1} = 3.4 \text{ Nm} - 0.6 \text{ Nm} = 2.8 \text{ Nm}$, M_{b2} unchanged).

The following adjustments should be made:

- electrical connection
- MD37 (activation of the function)
- MD48/49 (for monitoring of boost duration, see Section 7.3.6)
- In case your stepper drive features the “Current control through PWM” function, you can reduce the power loss converted in the motor, thereby reducing motor heating. This is possible because the acceleration moment is not needed. It is accomplished by reducing the motor current for idle and for constant travel phases proportional to the load moment. An advantage of reduced heating during constant travel becomes evident from the moment curve, particularly within the lower rpm range of the motor.

The following adjustments should be made:

- electrical connection
- MD37 (activation of the function)
- $MD50 = (M_{Load}(f_{max}) : M_{Motor}(f_{max})) \cdot 100\%$ (e.g. 60%)
- $MD51 = (M_{Load}(f = 0) : M_{Motor}(f = 0)) \cdot 100\%$ (e.g. 12%)

7.3.3 Basic startup of stepper motor control

Overview

Use the following flow charts to verify the drive actuation and that the machine data determined so far are correct. Since the FM 353 positions the stepper motor axis without using encoders (i.e., from control engineering standpoint, pure, direct control; see Fig. 7-10), special attention must be placed on evaluating the traversing movement. An initial test should be conducted to verify that the stepper motor will traverse as a matter of course in response to actuation by the FM 353. A second test should be conducted to verify positioning accuracy. (Always activate MD changes using “Activate MD”!)

Note

Always activate MD changes using “Activate machine data”!



Caution

Prior to triggering any traversing movements, check to make sure there is clearance for axis movement in the desired direction of travel!

Basic startup

Use the following flow chart to verify the drive actuation.

Starting the axis

Start the axis with the “space bar” after preselecting the direction via R+ or R-.

The “Windows properties” allow for successive execution of the command (repeated starting/stopping of the axis) when the “space bar” is depressed in quick succession.

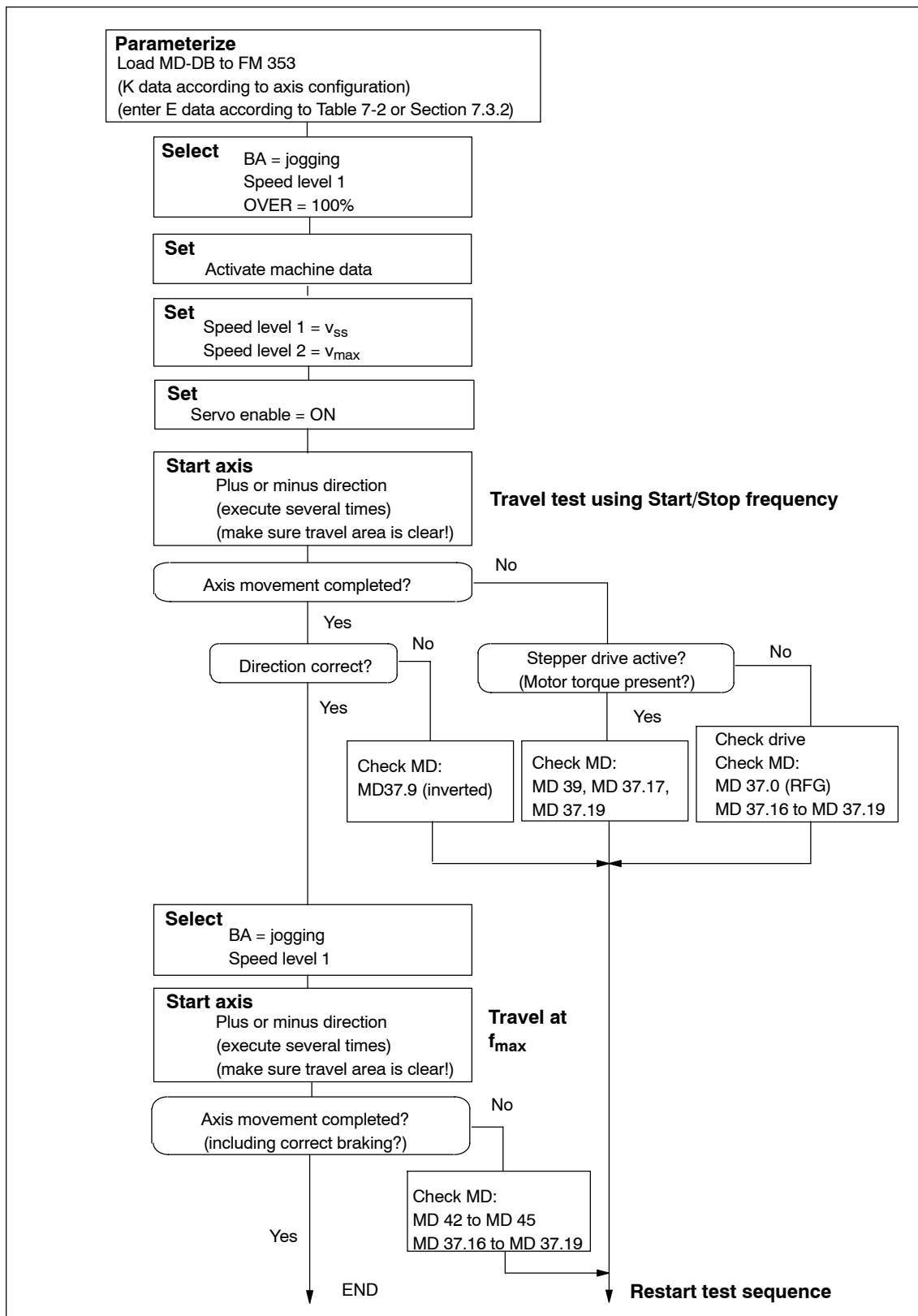

Fig. 7-8 Basic startup of stepper motor control

Positioning

Use the following flow chart to check axis travel to a target position.

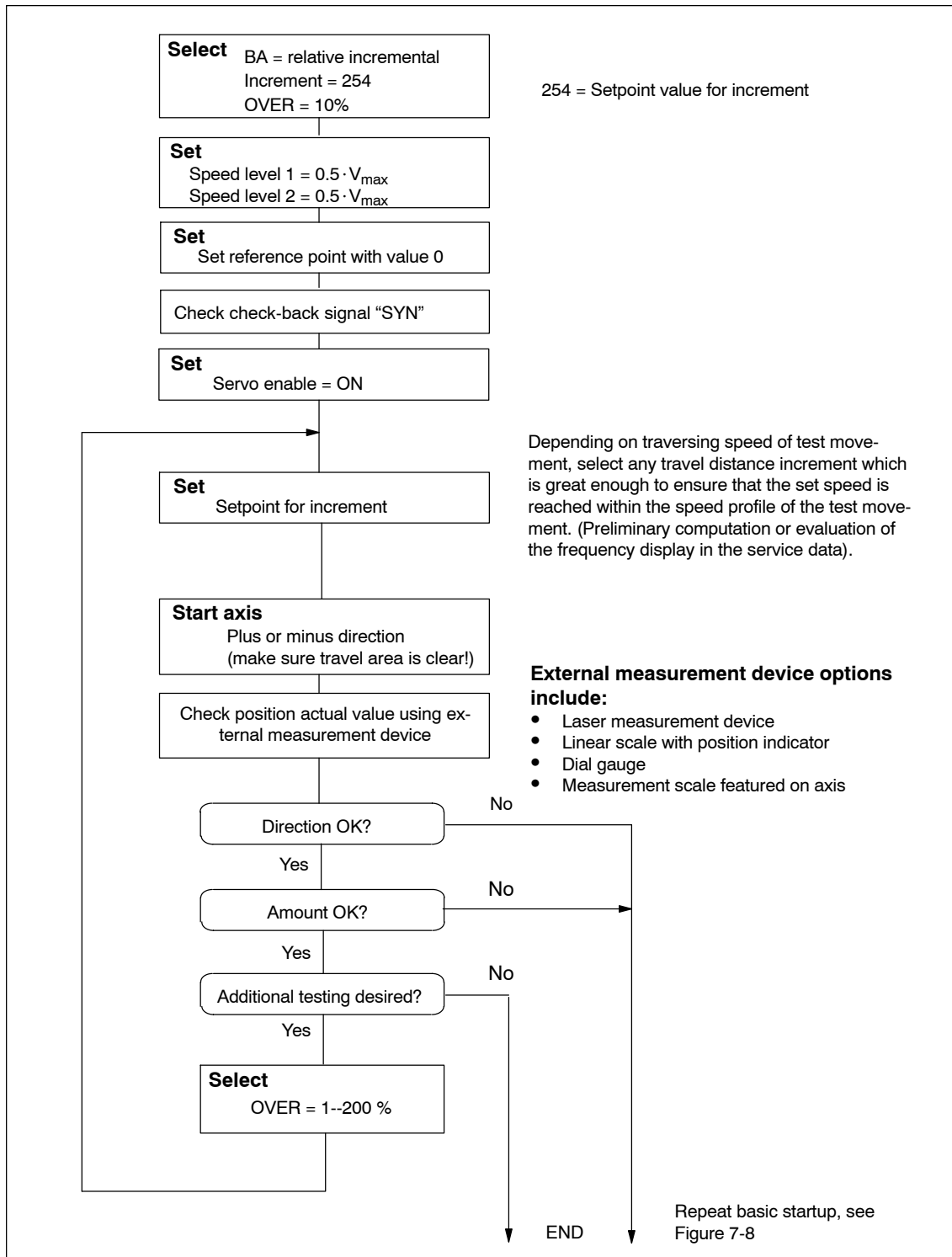

Fig. 7-9 Positioning verification

7.3.4 Optimization of dynamic response

Overview

The motor axis driven by the FM 353 is driven by pure, direct control. It features the following structure:

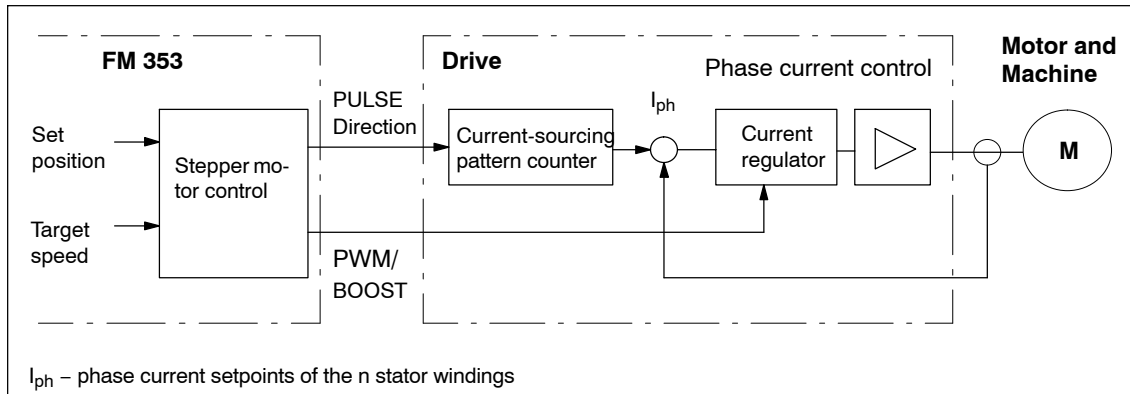

Fig. 7-10 Structure of the stepper motor axis

The dynamic response of the axis is determined by the design characteristics of the machinery, such as friction, backlash, torsion, and the like. Being an open-loop control module, the FM 353 must be subordinated to these factors as they bear on parameterization. Following completion of basic startup as described in Section 7.3.3, optimization of parameterization should now be carried out geared to these factors as well as to the technology.

Different requirements are imposed on the axis dynamic response for different technological applications. Criteria for evaluating the quality of the positioning procedure may include the following:

Assessment criteria for the quality of the positioning process can include:

- Constant acceleration curve (soft travel behavior)
- Good uniformity of the traversing movement (mechanical vibrations, stepper motor resonance!)
- Short positioning time

In most applications, several of these criteria will be important, so that most of the time parameter selection is possible only with some compromise involved.

Optimization of stepper motor control

The following table shows you how to make parameter quality selection for any given axis dynamic response desired. The time values MD46 and MD47 are added to the previously documented machine data from basic startup. These times are essentially needed on a stepper drive-specific basis. They amount to a few ms. However, should the axis machinery have a tendency to vibrate, they can be used e.g. in the case of seamless transition between acceleration and delay (e.g. when traversing short distances), in order to prevent the resultant doubling of acceleration jump, or to permit the vibration which is induced at this discontinuous location, to die out by adding a constant travel time.

Table 7-5 Effect of dynamic-defining MDs

	MD39	MD41	MD42...45	MD46	MD47
Soft travel behavior	small	–	small	great	great
Suppression of resonance	great	–	great	great	great
Short positioning time	great	great	great	small	small

Triggering test movements

You can use the following startup actions to optimize the stepper motor control to your requirements. This should include checking all speed ranges, and if applicable give the greatest weight in evaluating results to the speed that is most significant for your technology. Use the following procedure to trigger test movements on the axis to be optimized:

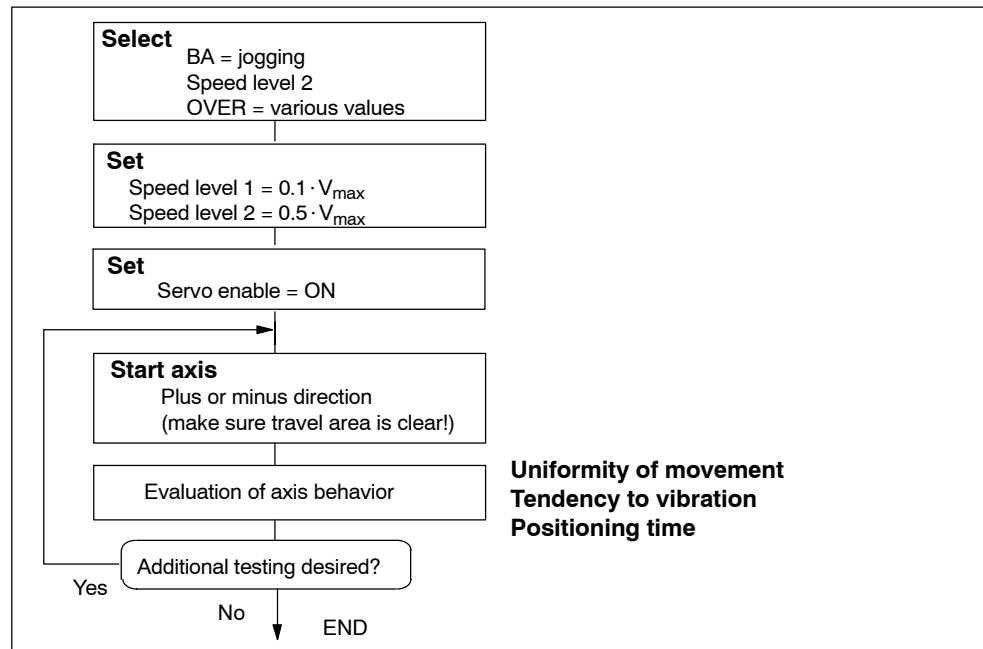

Fig. 7-11 Test movements for optimizing the stepper motor control system

7.3.5 Realigning the reference point coordinates

Axis

To ensure distinct reproducibility of reference recordings, it is necessary for the synchronizing zero pulse (SYNI) formed by an external zero pulse or by the “current-sourcing pattern zero” signal (see Section 9.7.2) to be a distinct distance away from the reference-point switch (RPS). At low reducing velocities, we recommend a distance of between 10% and 90% of the distance of one stepper motor revolution, or the distance of one current-sourcing pattern cycle. For high reducing velocities, we recommend 30% to 60%. Check this value in the servicing data report (switch alignment value), and if you find nonconformity to the required value range, make a corresponding adjustment in the relative position allocation between the zero pulse encoder or the stepper motor, and the reference-point switch.

Example: Positive search direction

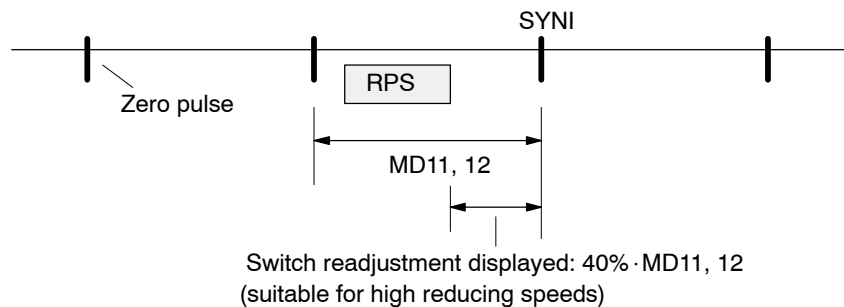

Set the referencing velocity to the highest value compatible with your requirements. It is important for it to be possible to brake to the reducing speed along the entire length of the reference-point switch (RPS). If this is not the case, an additional repositioning to the RPS occurs before the search phase begins. Compare the cycle of the executed traversing movements with Section 9.2.3 and optimize the referencing speed (MD28).

Then readjust the reference-point coordinates-proper by entering the necessary reference-point shift in the machine data. After the machine data is activated, the new reference-point shift takes effect with the next reference point approach.

7.3.6 Activating stepper motor diagnostics

Overview

Once optimization of stepper motor control is completed, activate the stepper motor diagnostics as needed.

Boost

The boost signal is monitored in terms of its active time. This is in order to protect the drive motor against overheating.

Refer to the stepper motor drive documentation for information regarding maximum absolute and relative boost duration. Enter this information into machine data MD48 and MD49, provided for that purpose.

When boost function is parameterized, the FM 353 triggers the errors “Boost duration absolute” or “Boost duration relative” in the event that time for the active phase(s) of the Boost signal is exceeded.

Once parameterization is completed, check the diagnostics function for efficacy using a suitable test program with which particularly large proportions of acceleration and braking phases occur during execution.

Rotation monitoring

Activation is accomplished by way of the “Rotation monitoring” single-setting function (refer to Section 9.7.3 for functional description of rotation monitoring).

If the rotation monitoring function is programmed, the FM 353 will trigger the “Rotation monitoring” error in the event that the stepper motor is unable to follow the movement specified.

Check the efficacy of the diagnostics function. This is accomplished by electrically separating the cyclic zero pulse encoder or the power section of the stepper motor and executing a test movement in any operating mode.

7.3.7 Activating the software limit switches and backlash compensation

Software limit switches

Move the axis carefully to the end positions defined for normal machining. Enter these position actual values into the machine data MD21/MD22 as software limit switches, and activate them.

Note

If you change the reference point coordinates, you must redefine the positioning values of the software limit switches.

If you do not need the software limit switches, the input limits -10^9 and 10^9 [MSR] must be entered in MD21/MD22 (for default values, see Table 5-4).

Backlash compensation

Due to play in the mechanical transmission elements, position deviation of the machine component to be positioned (e.g. lathe slide) may occur when a stepper motor is used for positioning. Normally, some travel distance “turns up missing” following a direction reversal. This backlash can be ascertained as an average at different axis positions. This can then be entered in the machine data set.

You can use the following flow chart to determine backlash and activate backlash compensation.

Also please refer to the information on “backlash compensation” presented in Section 9.7!

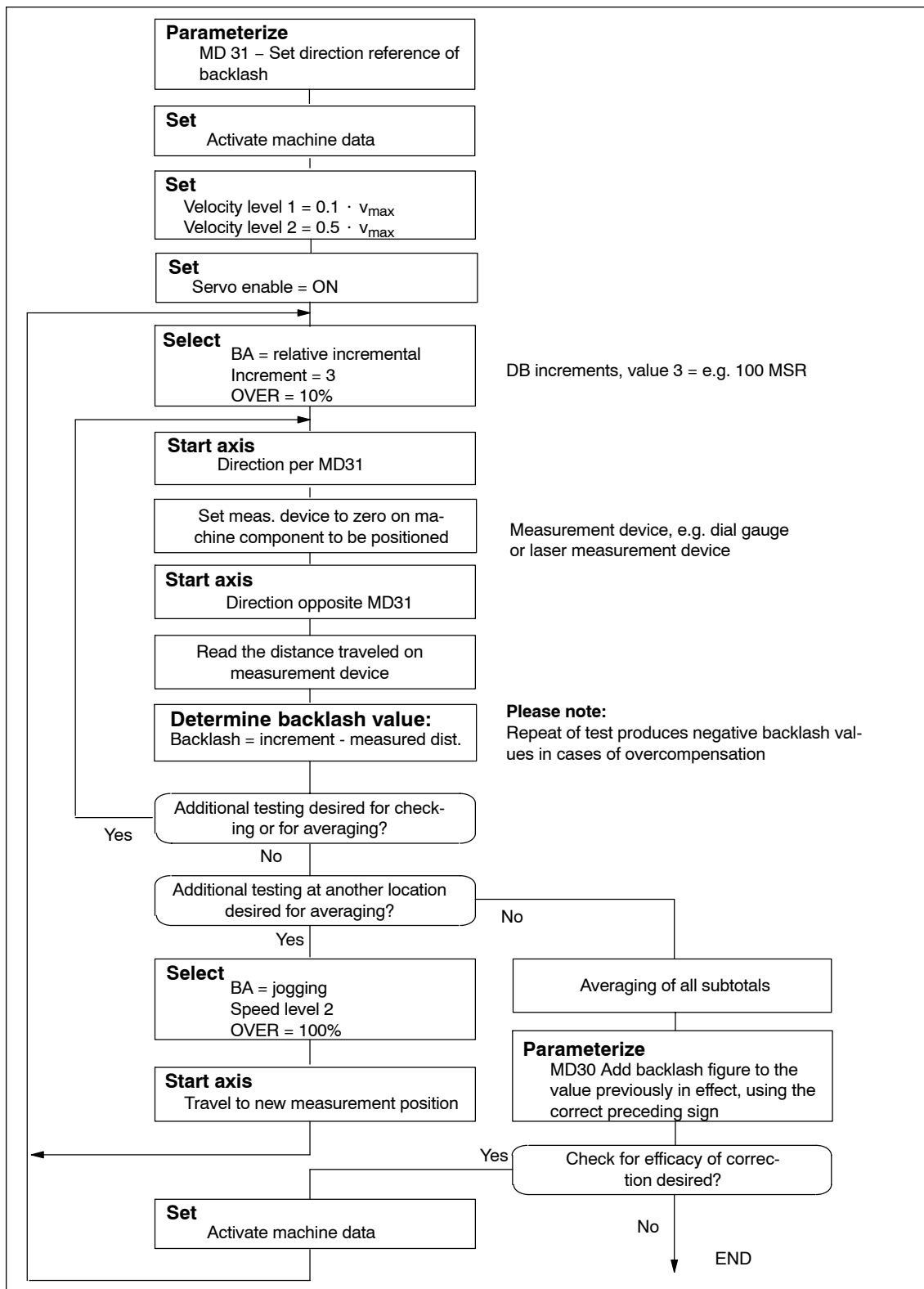

Fig. 7-12 Determining backlash and activating backlash compensation

7.3.8 Optimized motion profile

Positioning operations for short travels programmed in conjunction with the parameterization of relatively high accelerations (MD42...MD45) are performed within a few FM cycles.

In previous software versions, positioning times can occur which do not comply with the times calculated, but are considerably higher (depending on the path length programmed). When reducing the distance to be traversed, e.g. by a path corresponding to one step of the stepper motor, the following effect can occur: The positioning time is not reduced or remains unchanged, but the positioning can last longer by several FM cycles.

The possibility of mispositioning should not be excluded in conjunction with the causes for this behavior, even though such error messages had not been reported by now.

In the present software version, the functioning principle of the FM 353 can be switched to the "Optimized motion profile" mode.

MD56 Optimized motion profile (see Table 5-4)

Note

MD56 is zero ("0") by default. Thus, the default motion profile is activated; the functioning principle is the same as in the previous software versions.

No value monitoring with output of error messages is provided when entering MD56. In case of an illegal or invalid value assignment, the default motion command is activated.



Human-machine Interface

Chapter Overview

Section	Section Header	Page
8.1	Standard HMI (human-machine interface) for the OP 07 and the OP 17	8-3
8.2	Analysis of the user DB by the user program for operator control	8-17
8.3	Data block for status messages (DB-SS)	8-20

Summary

In this chapter you'll find an overview of the operator-control and monitoring capabilities offered by the FM 353.

For operator control and monitoring of the FM 353, a control panel can be connected to the CPU via the MPI interface (see Figure 1-2).

The FM can service no more than three nodes simultaneously.

The module uses the SIMATIC interface (backplane bus) to communicate with the control panel.

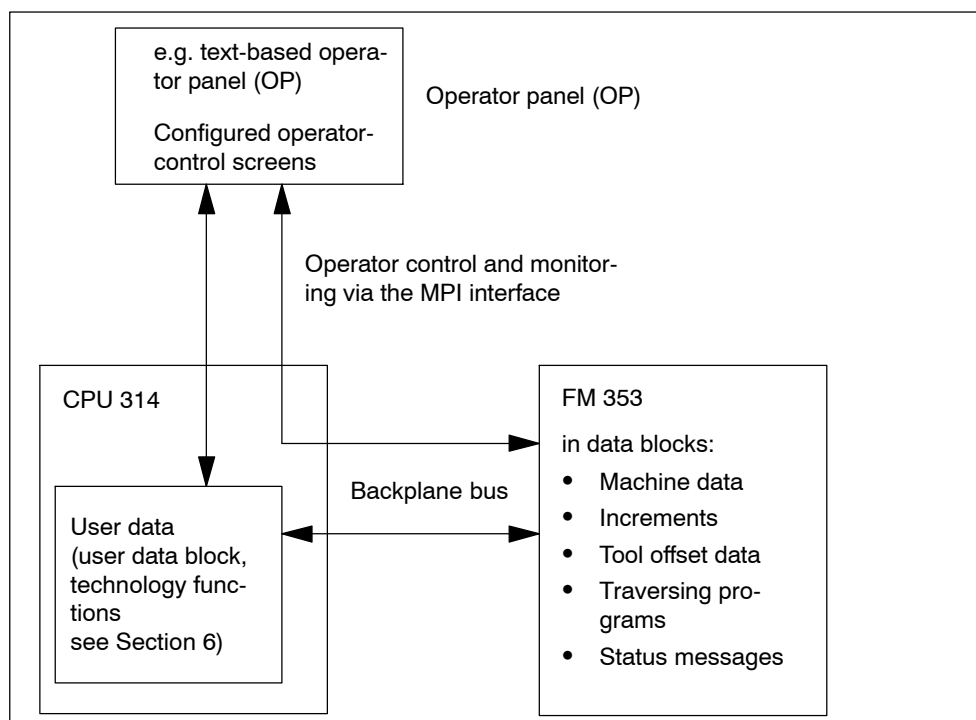

Fig. 8-1 Operator control and monitoring for the FM 353

Operator control and monitoring of FM data/signals on the CPU 314

The data and signals that can be controlled and monitored at the control panel are listed in the user data block. These data or signals must be processed by the user program (for data and signals see Chapter 6 and Section 8.1).

What can I control on the FM 353?

Using the keyboard of the operator panel, you can change the data/signals in the data blocks:

- Machine data DB No. 1210
- Increment sizes DB No. 1230
- Tool offset data DB No. 1220
- Traversing programs DB No. 1001...1199

What can I monitor on the FM 353?

The following data and signals can be displayed on the operator panel display:

- Machine data DB No. 1210
- Increment sizes DB No. 1230
- Tool offset data DB No. 1220
- Traversing programs DB No. 1001...1199
- Status messages DB No. 1000 (DB-SS) etc.
 - Operating data, such as actual values
 - Active NC blocks
 - Linear measurements
 - Actual value block change
 - Checkback signals and error conditions
 - Servicing data

The configuration package includes a pre-configured interface for the OP 07 and OP 17 operator panels.

8.1 Standard HMI (human-machine interface) for the OP 07 and the OP 17

Overview

This Section describes a preconfigured user interface, which you will need to change according to your project (e. g. FM addresses, DB no.), for the following COROS equipment (operator panels):

- OP 07
- OP 17

The tool to be used for this is the “ProTool/Lite” configuring tool. You can use it to modify, add or delete graphics.

The user interface is addressed to user DB No.1 in the CPU (target system 1, address = 2) and to the DB-SS of the FM 353 (target system 2, address = 3).

The text field “FM user name” represented in the images can be renamed to a text of your choice.

You can print out the entire configuration using “ProTool/Lite”. This provides you with detailed graphics descriptions.

You will find the preconfigured user interfaces **op07_353.pdb** and **op17_353.pdb** in the following directory:

[STEP7 directory]\EXAMPLES\FM353\zEn13_02_FM353_OP_EX

DB-SS

This data block for status messages (DB 1000) contains the control/checkback signals, as well as the system data of the FM 353. The data of the DB-SS can only be read.

Monitoring

The data for monitoring can be read and displayed directly in the DB-SS as well as in the corresponding parameterized DBs of the FM 353.

The advantage of reading directly from the FM is that the values/signals do not have to be read via the user program first.

Operator control

For operator control, the data and signals (including memory bits and values) are written to the user DB of the user program.

User program

User data block AW-DB is the interface for the OP.

When control signals, single functions and single commands are set in the user data block via the OP, they are immediately transferred to the FM by the POS_CTRL block.

The signals written in "Operator Control and Monitoring" (requests to transfer the data with Write as per Table 8-3) must be evaluated accordingly by the user program (taking into account any user-specific interlocks) before setting the Write or Read requests.

8.1.1 Standard user interface for the OP 07

User interface of the OP 07

The following illustration provides you with an overview of the OP 07 user interface (menu tree).

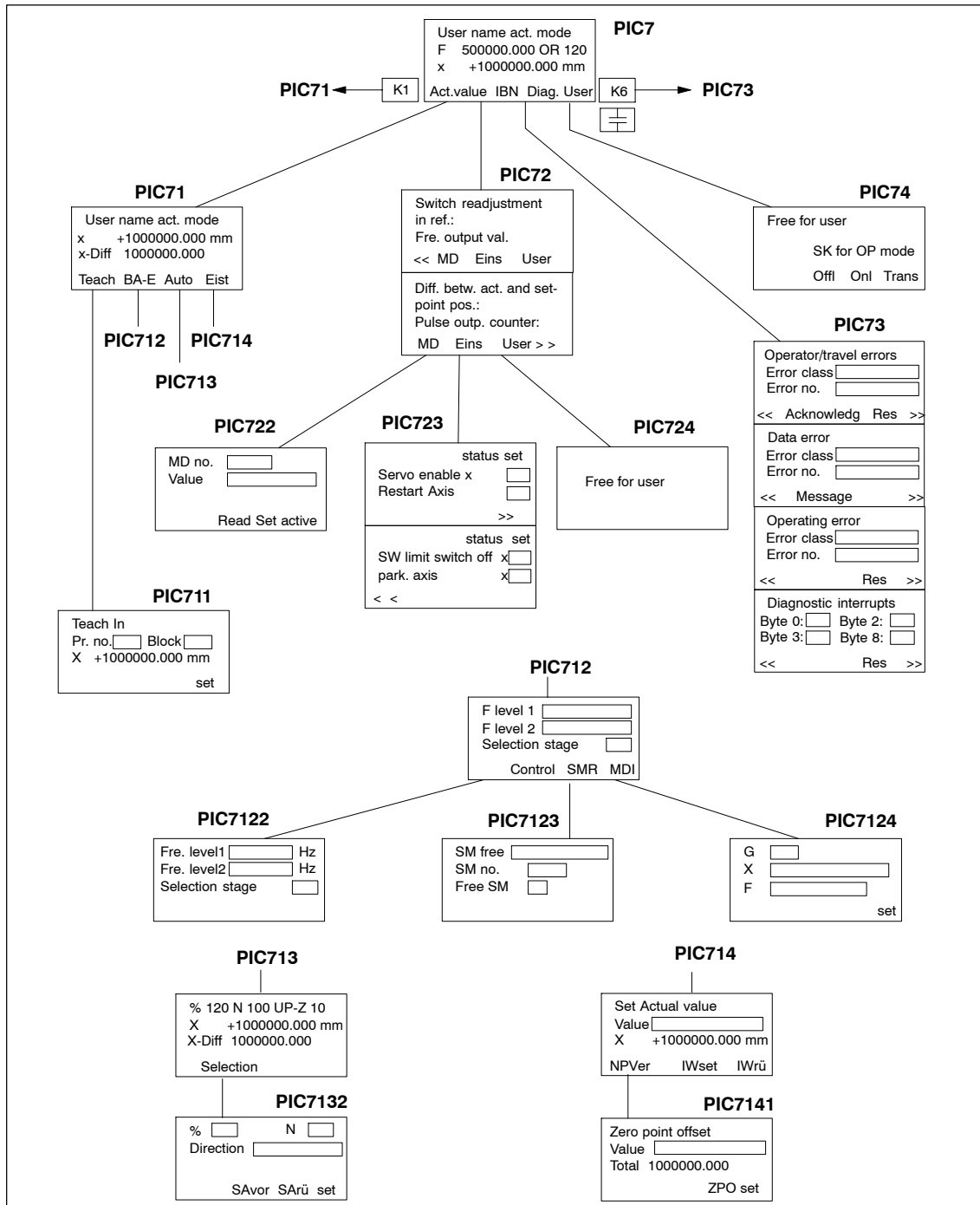





Fig. 8-2 Menu tree of the OP 07 user interface

Figure 8-2 describes the functions of the global function keys for the user interface of the OP 07.

- | | | |
|---|---------------------|---|
|  | ESC key | You can use this key to call up the previous screen of the higher levels. |
|  | Soft keys | You can use these keys to call up the next inset screen within the same screen (same screen number). |
|  | Function key | You can use this key to skip from any point in the menu tree to the actual value display main screen (PIC71). |
|  | Function key | You can use this key to skip from any point in the menu tree to the diagnostic main screen (PIC73). |

Note

The screens of the user interface (see Figure 8-2 and description of each screen, Table 8-1) contain display fields and input/output fields. These fields contain values of configured variables.

- The display fields are addressed to the DB-SS ("Control 2," DB1000) and are read directly from the FM 353.
 - The input/output fields are addressed to the user DB No.: 1 (Control 1-CPU).
 - Transmission of these values occurs from the OP 07 to the CPU into the user DB. These values (if needed) must be transmitted to the FM 353 by the user program.
 - If certain values or control signals can be written only under the right conditions (e.g. if axis is necessary on HOLD or selection of a certain operating mode), then the user program must ensure, by analyzing the response signals, that these conditions are met.
-

Table 8-1 below describes the individual screens of the user interface.

Table 8-1 Description of the screens in the user interface

Screen name	Screen No.	Description
Main screen	PIC7	This screen is displayed to you after the OP 07 is enabled. The FM353 values are display values. You can use the soft keys to call up the following main screens: <ul style="list-style-type: none"> • Softkey "Istw" → PIC71 • Softkey "IBN" → PIC72 • Softkey "Diag" → PIC73 • Softkey "Anw" → PIC74
Main screen, actual value display	PIC71	The values on the screen are display values. You can use the soft keys to call up the following screens: <ul style="list-style-type: none"> • Softkey "Teach" → PIC711 • Softkey "BA-E" → PIC712 • Softkey "Auto" → PIC713 • Softkey "Eist" → PIC714
Main screen, startup	PIC72	The FM 353 values (service data) are display values. You can use the soft keys to call up the following screens: <ul style="list-style-type: none"> • Softkey "MD" → PIC722 • Softkey "Eins" → PIC723 • Softkey "Anw" → PIC724
Main screen, diagnostics	PIC73	This screen shows you the diagnostic interrupts and error messages for the FM 353 in four lower-level screens. The following are displayed: <ul style="list-style-type: none"> • Error class and error number for operator control and guidance errors • The bit numbers of the single diagnostic interrupt bytes You can use the soft keys "Quit" and "Res" to acknowledge the errors. See Chapter 11.3 for diagnostic interrupts and error messages
User screens	PIC74 and PIC724	You can use these screens to configure your own contents.
Setting data for operating mode	PIC712	This screen contains input/output fields for the velocity levels or a text field for selecting velocity level (selections 1 or 2 possible). You can use the soft keys to call up the following screens: <ul style="list-style-type: none"> • Softkey "Steu" → PIC7122 • Softkey "SMR" → PIC7123 • Softkey "MDI" → PIC7124
Setting data for the "Automatic" operating mode	PIC713	This screen contains only display fields. You can use the "Anwahl" soft key to call up screen PIC 7132.
Set Actual value	PIC714	The actual value display is a display field. The value for set an actual value appears in an input/output field. You can use the soft key "NPVer" to call up the screen PIC7141. You can use the soft keys "Iwrü" and "IWset" to execute functions.

Table 8-1 Description of the screens in the user interface, continued

Screen name	Screen No.	Description
Machine data	PIC722	<p>This screen contains input/output fields. Input of values is password protected. The values entered are in the user DB. You can use the soft keys to set bits in the user DB:</p> <ul style="list-style-type: none"> • Soft key “lesen” – You can use this soft key to insert a memory bit (in the user DB) which causes the user program to read the item of machine data whose number has been entered. • Soft key “set” – You can use this soft key to set a bit which causes the user program transfer to the FM 353 the number entered under value for the item of machine data under MD No. • Soft key “aktiv” – You can use this soft key (activate MD) to set a memory bit (“activate MD” bit in the user DB) which is transmitted from the user program to the FM 353. <p>Each bit in the user DB which you set in this screen must be reset by the user program following execution of the function.</p>
Settings for startup	PIC723	<p>The fields of this screen which are identified by an “x” are display fields. If the bit is set, you will see an x. If the bit is not set, the field will be blank. The other fields are text entry fields in which you can toggle between “x” and “ ”.</p> <p>You can use the soft keys “<<” and “>>” to change between the inset screens of this screen.</p>
Set data for the “Control” operating mode	PIC7122	<p>This illustration contains input/output fields for the frequency levels or a text field for frequency level selection (Selection 1 or 2 possible).</p>
Set data for the “incremental mode, relative” operating mode	PIC7123	<p>This screen contains input/output fields. The fields “SM-No.” and “free SM” are addressed to the same address in the user DB. You can use the SM No. to enter the values 1 to 100. The “free SM” field is a text field and you can toggle back and forth between “x” and “ ”. If you select “x”, this corresponds to the value 254 for free SM. The value of the free SM is found in the user DB.</p>
Set data for the “MDI” operating mode	PIC7124	<p>This screen contains input/output fields. The MDI data record must be preassigned by the user program with the corresponding bits (G, X, F bits are set) and possibly, with values for G, X and F. The entry field behind G is a text field. There, you can select between the values 90 and 91.</p> <p>Using the soft key “set” you can set a memory bit (in the user DB), which must be analyzed by the user program. With modification of this bit, the MDI block must be transmitted from the user DB to the FM 353, and the bit must be reset.</p>

Table 8-1 Description of the screens in the user interface, continued

Screen name	Screen No.	Description
Program selection	PIC132	<p>This screen contains input/output fields. This field for direction is a text field. It is upward and downward selectable. You can use the soft keys to set bits in the user DB:</p> <ul style="list-style-type: none"> • Soft key "SAvor" - You can also use this soft key (automatic block search forward) or "SArü" (automatic block search backward) to set the corresponding bits in the user DB. • Soft key "set" - you can use this soft key to set a memory bit (in the user DB).
Teach In	PIC711	<p>This screen contains input/output fields. You can use the soft key "set" to set a bit in the user DB.</p> <p>The actual value display (X) is a display field.</p>
Zero offset	PIC7141	<p>This screen features an input/output field.</p> <p>The sum of the offsets (Sum Ver) is a display field.</p> <p>You can use the soft key "NPVset" to execute a function.</p>

8.1.2 Standard user interface for the OP 17

User interface of the OP 17

The following illustration provides you with an overview of the OP 17 user interface (menu tree).

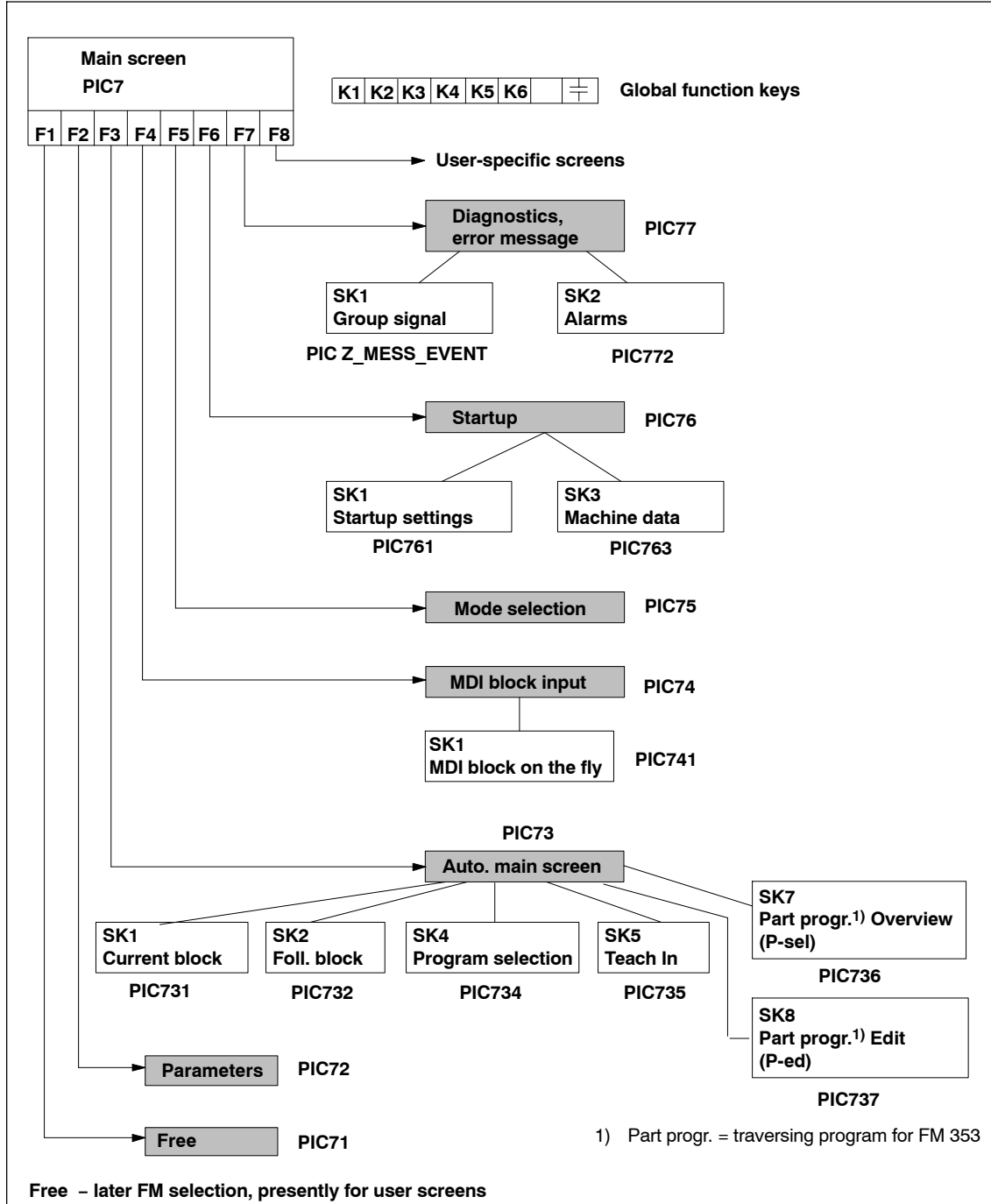









Fig. 8-3 Menu tree of the OP 17 user interface

Figure 8-3 describes the functions of the global function keys for the user interface of the OP 17.

 ESC key	You can use this key to call up the previous screen of the higher level (the table of contents in the main screen).
 Function key	You can use this key to jump from any point on the menu tree to the main screen (PIC7).
 Function key	You can use this key to jump from any point on the menu tree to the diagnostics error message screen (PIC77).
 Function key	You can use this key to jump from any point on the menu tree to the operating mode selection screen (PIC75).
 Function key	OP 17 “Offline” operating mode selection
 Function key	OP 17 “Online” (normal) operating mode selection
 Function key	OP 17 “Transfer” operating mode selection
 F1 ... F8	F1 to F8 (local soft keys)

Note

The screens of the user interface (see Figure 8-3 and description of the individual screens) contain display fields and input/output fields. These fields contain values of configured variables.

- The display fields are addressed to the DB-SS (“Control 2,” DB1000) and are read directly from the FM 353.
- The input/output fields are addressed to user DB No.: 1 (control 1-CPU).
 - Transmission of these values occurs from the OP 17 to the CPU into the user DB. These values (if needed) must be transmitted to the FM 353 by the user program.
 - If certain values or control signals can be written only under the right conditions (e.g. if axis is necessary on HOLD or selection of a certain operating mode), then the user program must ensure, by analyzing the response signals, that these conditions are met.

The pending errors are displayed in the errors line. More detailed error information is provided on the screens “Diagnostics, Troubleshooting” and “Interrupt messages.”

Description of the individual screens

The following illustration shows the screen layout of the preconfigured interface.

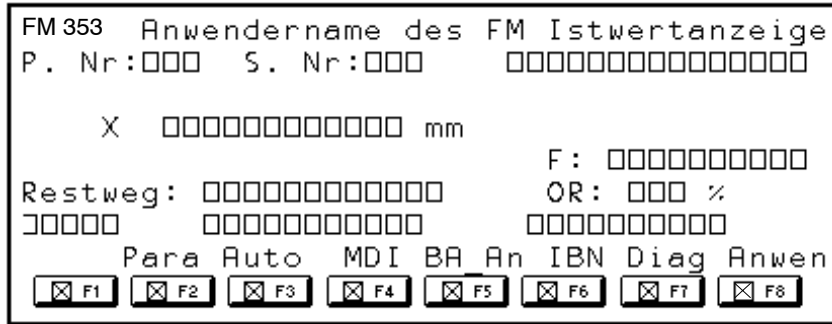

Fig. 8-4 Screen layout of the preconfigured interface

The illustrations shown below (Fig. 8-5 to Fig. 8-19) provide you with the screen content of the configured screens.

FM 353	Anwendername der FM		Istwertanzeige				
P. Nr.:		S. Nr.:					akt. Betriebsart
	x	+1000000.000	mm				
Restweg						F	
Alarm		Datenfehler				OR	
	Para	Autom	MDI	BA	An	IBN	Diag Anwen

Fig. 8-5 Main screen, PIC7

This screen is displayed to you after the OP 17 is enabled. The FM353 values are display values. The soft keys (F1 - F8) are used to request the continuation screens. The first and last soft keys (User) are kept free for the user to insert his/her own screens (e.g. including additional FMs).

FM 353	Anwendername der FM		BA-Anwahl				
							akt. Betriebsart
F-Stufe1							Auswahl Stufe X
F-Stufe 2							
Frq.-Stufe1			Hz			SM-Frei X	SM-Nr
Frq.-Stufe2			Hz			SM-Frei	
Alarm		Datenfehler				Fahrfehler	
	Tip	Steu	Refpk	SMR	MDI	AutoE	Autom

Fig. 8-6 Operating mode selection, PIC75

This screen permits you to enter the operating mode, velocity levels or control levels or the incremental value.

FM 353	Anwendername der FM	Teach In
		akt. Betriebsart
	Progr-Nr	
	Satz-Nr	
Istwert		
Alarm	Datenfehler	Fahrfehler
		set

Fig. 8-7 Teach In PIC735

This illustration displays the actual value for you. You can enter the values for Teach In.

FM 353	Anwendername der FM	MDI-Satzeingabe
		akt. Betriebsart
G1	x/t	M1
G2	F	M2
		M3
Alarm	Datenfehler	Fahrfehler
MDifl		set

Fig. 8-8 MDI block entry PIC74

The fields identified by an X are text fields and can be toggled back and forth between "X" and ". You can enter the values of the MDI block.

FM 353	Anwendername der FM	MDI-Satz flieg.
		akt. Betriebsart
G1	x/t	M1
G2	F	M2
		M3
Alarm	Datenfehler	Fahrfehler
MDI		set

Fig. 8-9 MDI block on the fly PIC741

Handling of the MDI block on the fly corresponds to that of the MDI block.

FM 353	Anwendername der FM				Automatik-GB			
P. Nr.:				S. Nr.:				akt. Betriebsart
aktive G-Fkt	G90	G60	G43					UP-2
								D
Istwert								F
Restweg								OR
Alarm		Datenfehler				Fahrfehler		
aktSA	folsA		%Wahl	Teach			P-sel	P-ed

Fig. 8-10 Automatic main screen PIC73

This screen contains only display fields.

In the screens PIC736 "Part program overview (P-sel)" and PIC737 "Part program Edit (P-ed)", you can select programs and read/write traversing program blocks.

FM 353	Anwendername der FM				Programmwahl			
P. Nr.:				S. Nr.:				akt. Betriebsart
Anwahl		Pr-N		SA-N				
		Richtung						
Alarm		Datenfehler				Fahrfehler		
		SAvor	SArü					set

Fig. 8-11 Program selection PIC734

This screen features input/output fields. It is upward and downward selectable.

FM 353	Anwendername der FM				aktueller Satz			
P. Nr.:				S. Nr.:				akt. Betriebsart
G1	<input checked="" type="checkbox"/>	x/t	<input checked="" type="checkbox"/>	UP	<input checked="" type="checkbox"/>			M1
G2	<input checked="" type="checkbox"/>	F	<input checked="" type="checkbox"/>	UP-2	<input checked="" type="checkbox"/>			M2
G3	<input checked="" type="checkbox"/>	D	<input checked="" type="checkbox"/>					M3
Restweg				aktiv	G90	G60	G43	D20
Alarm		Datenfehler				Fahrfehler		
folgSA								

Fig. 8-12 Current block PIC731

This screen contains only display fields.

FM 353	Anwendername der FM				folgender Satz			
P. Nr.:				S. Nr.:				akt. Betriebsart
G1	<input checked="" type="checkbox"/>	x/t	<input checked="" type="checkbox"/>	UP	<input checked="" type="checkbox"/>			M1
G2	<input checked="" type="checkbox"/>	F	<input checked="" type="checkbox"/>	UP-2	<input checked="" type="checkbox"/>			M2
G3	<input checked="" type="checkbox"/>	D	<input checked="" type="checkbox"/>					M3
Restweg								
Alarm		Datenfehler				Fahrfehler		
aktSA								

Fig. 8-13 Continuation block PIC732

This screen contains only display fields.

FM 353	Anwendername der FM	Parameter
		akt. Betriebsart
	Istwert setzen	
	Nullpunktverschiebung	
Istwert		Sum-V
Alarm	Datenfehler	Fahrfehler
	IWset	IWrü
		ZPOset

Fig. 8-14 Parameters, PIC72

The sum of the offsets and the actual value display are display fields.

FM 353	Anwendername der FM	Inbetriebnahme
		akt. Betriebsart
	Frequency output value	Hz
	Switch readjustment in ref.:	
	Diff. betw. act. and setpoint pos.:	
	Pulse output counter	
Alarm	Datenfehler	Fahrfehler
Einst	MD	

Fig. 8-15 Startup PIC76

The FM 353 values (service data) are display values.

FM 353	Anwendername der FM	IBN-Einstellung
		akt. Betriebsart
	Reglerfreigabe	<input checked="" type="checkbox"/> nein
	parkende Achse	<input checked="" type="checkbox"/> nein
	Softw-endsch. abschalten	<input checked="" type="checkbox"/> nein
	Restart Achse	<input checked="" type="checkbox"/>
	Restweg löschen	<input checked="" type="checkbox"/>
Alarm	Datenfehler	Fahrfehler

Fig. 8-16 Startup settings PIC761

The fields in which an "X" is entered are display fields.

FM 353	Anwendername der FM	Maschinendaten
		akt. Betriebsart
	MD-Nr	Wert DEZ
		HEX
	BIN	
Alarm	Datenfehler	Fahrfehler
	lesen	aktiv
		set

Fig. 8-17 Machine data PIC763

Value input is password protected.

FM 353	Anwendername der FM	Diagnose
		akt. Betriebsart
Fehlerklasse	Fehler	
Meld	Alarm	Res Quit

Fig. 8-18 Diagnostic, error message PIC77

This screen displays the FM 353 errors. The fields are display fields.

FM 353	Anwendername der FM	Alarmmeldungen
Alarmklasse	Alarm	
Meld	Fehler	Res

Fig. 8-19 Interrupt messages PIC772

This screen displays the FM 353 errors. The fields are display fields.

The screen "PICZ_MESS_EVENT" contains factory-supplied default "ProTool/Lite" screens for the OP17.

8.2 Analysis of the user DB by the user program for operator control

Overview

The Table below tells you which Write requests must be submitted by the user program and which signals are written directly to the FM.

Table 8-2 Analysis of the user DB by the user program

OP 07/17	Triggered by ...	User program		see PIC...	
		Function	User DB, DBX...	OP 07	OP 17
499.5 499.6 499.7	FM 353	Diagnostic interrupt Data error Operator/traversing error		–	7
499.1 = 1	SK "IWset"	Transfer data for "Set actual value" from the user DB to the FM	38.7	714	72
499.2 = 1	SK "NPVset"	Transfer data for "Set zero point offset" from the user DB to the FM	39.1	7141	
37.6 = 1	SK "IWrü"	Transfer "Rescind actual value setting" to the FM		714	
37.2 = 1	SK "SAvor"	Transfer "Block advance" to the FM		7132	734
37.3 = 1	SK "SArü"	Transfer "Block return" to the FM			
498.3 = 1	SK "set"	Transfer data for "Program selection" from the user DB to the FM	39.5		
498.4 = 1	SK "set"	Transfer data for "Teach-in" from the user DB to the FM	39.7	711	735
498.2 = 1	SK "set"	Transfer data for "MDI block entry" from the user DB to the FM	38.3	7124	74
499.0 = 1	SK "set"	Transfer data for "MDI block on-the-fly" from the user DB to the FM	38.4	–	741
34.0	TF "servo enable"	To change "Servo enable", transfer yes/no to the FM		723	761
34.6	TF "parking axis"	To change "Parking axis", transfer yes/no to the FM			

SK = Softkey, TF = Text field

- 1) The relevant code for the operating mode (BA) is to be entered in DBB16 of the user DB.
- 2) Code = 254 in DBB17 of the user DB
- 3) User DB, DBB196 = 1, DBB197 from DBW500+1, DBB198 = 1, DBB199 = 1
- 4) User DB, DBB196 = 1, DBB197 from DBW500+1, DBB198 = 1, DBB199 = 4, DBD200 of DBD502
- 5) User DB, DBBX499.5 must be acknowledged with DBX515.7; DBX399.6 and DBX399.7 must be acknowledged with DBX515.6

Table 8-2 Analysis of the user DB by the user program

OP 07/17	Triggered by ...	User program		see PIC...	
		Function	User DB, DBX...	OP 07	OP 17
514.6 = 1	SK "Tipp"	Transfer data for "Jog" mode and "Jog" mode ¹⁾ to the FM	38.0	–	75
514.0 = 1	SK "Steu"	Transfer data for "Control" mode and "Control" mode ¹⁾ to the FM	38.1		
514.1 = 1	SK "Refpk"	Transfer "Reference point approach" mode ¹⁾ to the FM			
514.2 = 1	SK "SMR"	Transfer data for "Incremental relative" mode and "Incremental relative" mode ¹⁾ to the FM	38.2 ²⁾		
514.3 = 1	SK "MDI"	Transfer "MDI" mode ¹⁾ to the FM			
514.4 = 1	SK "AutoE"	Transfer "Automatic single block" mode ¹⁾ to the FM			
514.5 = 1	SK "Autom"	Transfer "Automatic" mode ¹⁾ to the FM			
35.6	TF "software limit switch off"	To change "Disable software limit switch", transfer yes/no to the FM		723	761
37.5= 1	TF "Restart axis"	Transfer "Restart axis" to the FM		723	
37.1= 1	TF "Delete distance to go"	Transfer "Delete distance-to-go" to the FM		–	
498.1 = 1	SK "read"	Read MD No. from the user DB, retrieve its value from the FM, and enter that value in the user DB	³⁾ 39.3 43.3	722	763
37.0 = 1	SK "active"	Transfer "Activate MD" to the FM			
498.0 = 1	SK "set"	Transfer MD No. and its value from the user DB to the FM	⁴⁾ 39.3		
515.7 = 1	SK "Res"	Error acknowledgement "Res" in the FM 353 (diagnostic interrupt)	⁵⁾	73	77
515.6 = 1	SK "Ack"	Error acknowledgement "Ack" in the FM 353 (data error, operator/traversing error)			

SK = Softkey, TF = Text field

1) The relevant code for the operating mode (BA) is to be entered in DBB16 of the user DB.

2) Code = 254 in DBB17 of the user DB

3) User DB, DBB196 = 1, DBB197 from DBW500+1, DBB198 = 1, DBB199 = 1

4) User DB, DBB196 = 1, DBB197 from DBW500+1, DBB198 = 1, DBB199 = 4, DBD200 of DBD502

5) User DB, DBBX499.5 must be acknowledged with DBX515.7; DBX399.6 and DBX399.7 must be acknowledged with DBX515.6

Variables in the user DB

The Table below contains the signals/data that must be entered in the user DB via the OP (FM interface).

For a detailed description of the structure of the user DB, see Section 6.6.

Table 8-3 Variables for the user DB

User DB	Variable type	Description	User DB
DBB17	BYTE	Velocity or frequency level 1, 2 [BP]	–
DBX34.0 DBX34.6 DBX35.6	BOOL	Single functions Servo enable Parking axis Disable software limit monitoring	Internal Write re- quest
DBX37.0 DBX37.1 DBX37.2 DBX37.3 DBX37.5 DBX37.6	BOOL	Single commands Activate machine data Delete distance-to-go Automatic block advance Automatic block return Restart Undo set actual value	Internal Write re- quest
DBD140	DINT	Zero offset	DBX39.1
DBD144	DINT	Set actual value	DBX38.7
DBD156	DWORD	Setpoint for incremental dimension	DBX38.2
DBD160	DWORD	Speed level 1	DBX38.0
DBD164	DWORD	Speed level 2	
DBD168	DWORD	Frequency level 1	DBX38.1
DBD172	DWORD	Frequency level 2	
DBB176 to DBB195	STRUCT	MD block	DBX38.3
DBB222 to DBB241	STRUCT	MD block on-the-fly	DBX38.4
DBB242	BYTE	Program selection – program number	DBX39.5
DBB243	BYTE	Program selection – block number	
DBB244	BYTE	Program selection – direction	
DBB250	BYTE	Teach In – program number	DBX39.7
DBB251	BYTE	Teach In – block number	
DBW500	WORD	MD No.	–
DBD502	DINT/ relev. MD	MD value	–
DBB506	BYTE	SM No.	–

8.3 Data block for status messages (DB-SS)

Overview

The following table lists the parameters/data that can be read out during operation.

Table 8-4 Parameters/data of the DB-SS (DB No. 1000)

Byte	Variable type	Value	Significance of the variables	Comment
0...35			DB header	
36...59			Internal header information	
Offset ¹⁾	Variable type	Value	Significance of the variables	Comment
24	8 x BOOL		Control signals	Byte 0
25	8 x BOOL		Control signals	Byte 1
26	2 x BYTE		Control signals	Byte 2, 3
28	2 x BYTE		Control signals	Byte 4, 5
30	8 x BOOL		Checkback signals	Byte 0
31	8 x BOOL		Checkback signals	Byte 1
32	BYTE		Checkback signals	Byte 2
33	8 x BOOL		Checkback signals	Byte 3
34	BYTE		Checkback signals	Byte 4
35	8 x BOOL		Checkback signals	Byte 5
36	12 x BYTE		Reserved	
48	DWORD		Velocity level 1	
52	DWORD		Velocity level 2	
56	DWORD		Frequency level 1	
60	DWORD		Frequency level 2	
64	DWORD		Setpoint for incremental value	
68	STRUCT	MDI block struc.	MDI block	
88	16 x BOOL		Single functions	
90	16 x BOOL		Single commands	
92	DINT		Zero offset	
96	DINT		Set actual value	
100	DINT		Set actual value on the fly	
104	16 x BOOL		Digital inputs/outputs	
106	STRUCT	MDI block struc.	MDI block on the fly	

- 1) A variable in the S7 protocol is addressed by the DB No. and, depending on data format, by the DBB, DBW and DBD No. (offset in DB), as well.

Table 8-4 Parameters/data of the DB-SS (DB No. 1000), continued

Offset ¹⁾	Variable type	Value	Significance of the variables	Comment
126	BYTE		Program selection	Program number
127	BYTE		Program selection	Block number
128	2 x BYTE		Program selection	Direction, free
130	4 x BYTE		Request application data	Application data 1-4
134	BYTE		Teach In	Prog. no.
135	BYTE		Teach In	Block number
136	DINT		Reference coordinate	
140	4 x DINT		Free	
156	DINT		Actual position	Basic operating data
160	DINT		Actual velocity	Basic operating data
164	DINT		Distance-to-go	Basic operating data
168	DINT		Target position	Basic operating data
172	DINT		Sum of current tool offset	Basic operating data
176	DINT		Rotational speed, rotary axis	Basic operating data
180	DINT		Free	
184	DINT		Free	
188	STRUCT	NC block struc.	Active NC block	
208	STRUCT	NC block struc.	Next NC block	
228	DINT		Code application 1	Application data
232	DINT		Code application 2	Application data
236	DINT		Code application 3	Application data
240	DINT		Code application 4	Application data
244	DINT		Actual position on leading edge	Length measurement/ inprocess meas.
248	DINT		Actual position on trailing edge	Length measurement
252	DINT		Length measurement value	Length measurement
256	DINT		Actual value at ext. block change	
260	DINT		Frequency output value	Servicing data
264	DINT		Pulse output counter (0...2 ¹⁶ -1)	Servicing data
268	DINT		Free	
272	DINT		Free	
276	DINT		Difference between setpoint and actual positions	Servicing data
280	DINT		Free	

1) A variable in the S7 protocol is addressed by the DB No. and, depending on data format, by the DBB, DBW and DBD No. (offset in DB), as well.

Table 8-4 Parameters/data of the DB-SS (DB No. 1000), continued

Offset ¹⁾	Variable type	Value	Significance of the variables	Comment
284	DINT		Switch readjustment in "Reference point approach" mode	Servicing data
288	DINT		Free	Servicing data
292	8 x DINT		Free	
324	BYTE		Override	Add. operating data
325	BYTE		NC part program no.	
326	BYTE		NC block no.	Add. operating data
327	BYTE		No. of callup subroutine loops	Add. operating data
328	BYTE		G90/91 Active	Add. operating data
329	BYTE		G60/64 Active	Add. operating data
330	BYTE		G43/44 Active	Add. operating data
331	BYTE		Active D No.	Add. operating data
332 332.1	8 x BOOL BOOL		Status messages 1 • Velocity limitation to limit value from MD	Additional operating data
333 333.0 333.1 333.3	8 x BOOL BOOL BOOL BOOL		Status messages 2 • Start/Stop frequency • Frequency value f. accel. switching • Acceleration/delay value is limited	
334	2 x BYTE		Free	
336	4 x 8 x BOOL		Diagnostics, system-specific	
340	4 x BYTE		Diagnostics, channel-specific	Identifier
344	2 x 8 x BOOL		Diagnostics, channel-specific	Channel error
346	4 x 8 x BOOL		Free	
350	2 x BYTE		Error number DS 162	Operator/travel error
352	BYTE		Free	
353	BYTE		Free	
354	2 x BYTE		Error number DS 163	Data error
356	BYTE		Free	
357	BYTE		Free	
358	2 x BYTE		Error number DS 164	Operational error
360	BYTE		Free	
361	BYTE		Free	
362	32 x BOOL		Process interrupt	

1) A variable in the S7 protocol is addressed by the DB No. and, depending on data format, by the DBB, DBW and DBD No. (offset in DB), as well.

The control and checkback signals in Table 8-4 can be the following signals:

Byte \ Bit	7	6	5	4	3	2	1	0
Control signals:								
24					BFQ/ FSQ		TFB	
25	AF	SA	EFG	QMF	R+	R-	STP	ST
26	BA							
27	BP							
28	OVERR							
29								
Checkback signals:								
30	PARA			DF	BF/FS		TFGS	
31		PBR	T-L			WFG	BL	SFG
32	BAR							
33	PEH		FIWS	SRFG	FR+	FR-	ME	SYN
34	MNR							
35				AMF				

The following table describes the control and checkback signals in German and English.

Table 8-5 Control and checkback signals

German	English	Description
Control signals		
TFB	TEST_EN	Switch P bus interface to "Start-up"
BFQ/FSQ	OT_ERR_A	Acknowledge operator and traversing errors
ST	START	Start
STP	STOP	Stop
R-	DIR_M	Negative direction
R+	DIR_P	Positive direction
QMF	ACK_MF	Acknowledgement for M function
EFG	READ_EN	Read Enable
SA	SKIP_BLK	Skip block
AF	DRV_EN	Drive Enable

Table 8-5 Control and checkback signals, continued

German	English	Description
BA	MODE_IN	Mode
		Jog
		Control
		Reference point approach
		Incremental relative
		MDI
		Automatic
		Code
		01
		02
		03
		04
		06
		08
		09
BP	MODE_TYPE	Operating parameters
		Speed levels
		Frequency levels
		Incremental dimension selection
		Code
		1 and 2
		1 and 2
		1...100, 254
OVERR	OVERRIDE	Override
Checkback signals		
TFGS	TST_STAT	Switching of P bus interface completed
BF/FS	OT_ERR	Operator/traversing errors
DF	DATA_ERR	Data error
PARA	PARA	Channel initialized
SFG	ST_ENBLD	Start Enable
BL	WORKING	Execution in progress
WFG	WAIT_EI	Waiting for external Enable
T-L	DT_RUN	Dwell time running
PBR	PR_BACK	Reverse program scanning
BAR	MODE_OUT	Active mode
SYN	SYNC	Channel synchronized
ME	MSR_DONE	Measurement completed
FR-	GO_M	Negative travel
FR+	GO_P	Positive travel
SFRG	ST_SERVO	Servo enable status
FIWS	FVAL_DONE	On-the-fly setting of actual value completed
PEH	POS_RCD	Position reached. Stop.
MNR	NUM_MF	M function number
AMF	STR_MF	M function modification



Description of Functions

9

Chapter Overview

Section	Section Header	Page
9.1	Control and checkback signals	9-2
9.2	Operating modes	9-14
9.3	System data	9-37
9.4	System of measurement	9-59
9.5	Axis type	9-60
9.6	Determining the position	9-63
9.7	Stepper motor control system	9-66
9.8	Digital inputs/outputs (Read request in the user DB, DBX43.4)	9-77
9.9	Software limit switches	9-80
9.10	Process interrupts	9-81

Overview

This chapter describes the functions of the FM 353.

You can activate these functions via the user program by calling the appropriate standard function blocks or technology functions.

9.1 Control and checkback signals

Overview

The **POS_CTRL** block transfers the control signals from the user DB to the module and transfers the checkback signals from the module to the user DB.

Byte \ Bit	7	6	5	4	3	2	1	0
Control signals:								
14					BFQ/ FSQ		TFB	
15	AF	SA	EFG	QMF	R+	R-	STP	ST
16	BA							
17	BP							
18	OVERR							
19								
Checkback signals:								
22	PARA			DF	BF/FS		TFGS	
23		PBR	T-L			WFG	BL	SFG
24	BAR							
25	PEH		FIWS	SRFG	FR+	FR-	ME	SYN
26	MNR							
27				AMF				
28	ACT_POS 1)							
29								
30								
31								

1) With FM firmware version V3.7.6 in conjunction with the blocks of the "FM353_354" library.

9.1.1 Control signals

Overview

The axis is operated and controlled by means of control signals.

Table 9-1 describes the control signals and their functions.

Table 9-1 Control signals

Symbol		Name	Function
English	German		
TEST_EN	TFB	Sw./over P-bus interface	Interrupts communication with the user program, and switches over the P bus interface for operation with the start-up user interface.
OT_ERR_A	BFQ/ FSQ	Acknowled. operator/travel error	... resets an error message. Before acknowledging the error, correct its cause.
START	ST	Start	... starts movement in "Automatic", "MDI" and "Reference-point approach" modes.
STOP	STP	Stop	... interrupts movement or processing of the program ... cancels reference point approach.
DIR_M	R-	Direction minus	... moves axis in negative direction. <ul style="list-style-type: none"> • In Jogging and Control modes, moves axis in negative direction (level-dependent). • Starts movement in negative direction in Incremental relative and Reference-point approach modes. • Specifies direction of movement for rotary axes in MDI and Automatic modes.
DIR_P	R+	Direction plus	... moves axis in positive direction. <ul style="list-style-type: none"> • In Jogging and Control modes, moves axis in positive direction (level-dependent). • Starts movement in positive direction in Incremental relative and Reference-point approach modes. • Specifies direction of movement for rotary axes in MDI and Automatic modes.
ACK_MF	QMF	Acknowledge M function	... only "acknowledge-driven" during M function output (see machine data list in Table 5-4, MD32). ... acknowledges receipt of M function. Program sequence can be continued.
READ_EN	EFG	Read-in enable	... prevents read-in (processing) of the next block ... has effect only in Automatic mode. The read-in enable is required in order to read in the next traversing block during program execution.
SKIP_BLK	SA	Skip block	... skips identified blocks in the program ... has effect only in Automatic mode.

Table 9-1 Control signals, continued

Symbol		Name	Function														
English	German																
DRV_EN	AF	Drive enable	<p>... enables movement.</p> <p>When the signal is reset, a deceleration of the movement takes place.</p> <p>If MD 37.15 = 0, program execution or the movement is aborted and the distance to go deleted.</p> <p>If MD 37.15 = 1, the following applies (machining resumed after emergency stop):</p> <ul style="list-style-type: none"> • Rapid deceleration of the movement. • On axis standstill FR+ or FR- = 0; BL = 1 the drive remains activated and Servo Enable active • If an error occurs in this state (e.g. the user starts the movement without a Start Enable, etc.), the relevant error response is initiated, e.g. the distance to go is deleted; BL = 0 (a new path must be specified). 														
MODE_IN	BA	Operating mode	<p>Operating mode (see Section 9.2)</p> <table border="0"> <tr> <td>Jogging</td> <td>01</td> </tr> <tr> <td>Open-loop control</td> <td>02</td> </tr> <tr> <td>Reference point approach</td> <td>03</td> </tr> <tr> <td>Incremental relative</td> <td>04</td> </tr> <tr> <td>MDI</td> <td>06</td> </tr> <tr> <td>Automatic</td> <td>08</td> </tr> <tr> <td>Automatic single block</td> <td>09</td> </tr> </table>	Jogging	01	Open-loop control	02	Reference point approach	03	Incremental relative	04	MDI	06	Automatic	08	Automatic single block	09
Jogging	01																
Open-loop control	02																
Reference point approach	03																
Incremental relative	04																
MDI	06																
Automatic	08																
Automatic single block	09																
MODE_TYPE	BP	Mode parameter	<p>... selects speed levels in Jogging mode</p> <p>... selects frequency levels in Control mode</p> <p>... selects increment in Incremental relative mode (value 1 – 100 or 254).</p>														
OVERRIDE	OVERR	Override	<p>... affects response of traversing movement. Range: 0-255%</p> <p>... override has no effect in Control mode</p> <ul style="list-style-type: none"> • Velocity override <p>Range: 0-255%</p> <p>Speed adjusted by percentage</p> <p>Example: Override doubled from 100% to 200%</p> <p style="text-align: center;"> $v_{act} = \frac{v_{prog} \cdot \text{Override}}{100}$ </p> <ul style="list-style-type: none"> - speed v is doubled - acceleration and deceleration values are not affected <p>The positioning time is not cut in half.</p>														

Table 9-1 Control signals, continued

Symbol		Name	Function
English	German		
OVERRIDE	OVERR	Override	<ul style="list-style-type: none"> Time override <p>If you parameterize the "time override" function in MD37, there are two ranges:</p> <ul style="list-style-type: none"> range 100-255%: speed override operates as described above range 0-100%: time override operative <p>Speed, acceleration and deceleration are changed in such a way that the time necessary for the traversing movement is directly correlated with the override value.</p> <p>Example: Cut override in half, from 100% to 50%</p> <ul style="list-style-type: none"> speed v is cut in half acceleration and deceleration are quartered Cut override in Start/Stop frequency $v_{act} = \frac{v_{prog} \cdot \text{Override}}{100} \quad a_{act} = \frac{a \cdot \text{Override}^2}{100^2} \quad t_{act} = \frac{t \cdot 100}{\text{Override}}$ <p>Positioning time is doubled.</p> <p>Taking the override into account as a time override presupposes the following additional condition:</p> <p>If a traversing movement consists of multiple positioning blocks with block change on-the-fly (the axis does not stop between blocks), changing the override value affects only the speed. Acceleration and deceleration are additionally affected only after the axis comes to a stop (e.g., reversal of direction).</p> <p>Note:</p> <p>Time override has effect only in the MDI and Automatic modes.</p>

Note

For further functions, **settings and commands** concerning open-loop control, see Section 9.3.2 and Section 9.3.3.

9.1.2 Checkback signals

Overview

The checkback signals indicate the processing status of the axis and report it to the user program.

Table 9-2 describes the checkback signals and their functions.

Table 9-2 Checkback signals

Symbol		Significance	Function
English	German		
TST_STAT	TFGS	Sw./over P bus interface complete	Communication with the user program is not possible, since the P bus interface has been switched over for operation with the start-up tool.
OT_ERR	BF/FS	Operator/travel errors	... signaled to the user if an operator-control error or travel error is pending (e.g., unallowed control signal has been set, (R+) and (R-) set simultaneously) An error message causes the movement to be canceled. See Section 11
DATA_ERR	DF	Data error	... is reported to the user when a data error occurs. see Section 11
PARA	PARA	Parameterize	... module parameterized. All machine data applicable for control of an axis are present on the module.
ST_ENBLD	SFG	Start enable	... signals that the FM 353 is ready for positioning and output. <ul style="list-style-type: none"> • “Start enable” is set: <ul style="list-style-type: none"> – if no static stop or error is pending and the drive enable is pending – if the mode setting and mode checkback match (after mode change) – if no axis functions (including M output, dwell time) are active, or after functions have been completed – for further processing of a function interrupted with unprogrammed stop – in Automatic mode, after program has been selected (one program active) and after M0, M2, M30, or at end of block with Automatic single-block • “Start enable” is deleted: <ul style="list-style-type: none"> – if a function has been started and is active, or – if a start condition is active (stat.) – if there is an error and an unprogrammed stop • Without Enable Start, none of the functions that can be operated with Travel Plus, Travel Minus and Start can be executed.

Table 9-2 Checkback signals, continued

Symbol		Significance	Function
English	German		
WORKING	BL	Processing in progress	<p>... indicates that a function has been started with Start or Travel Plus/Minus, and is active.</p> <ul style="list-style-type: none"> • “Processing in progress” is set with: <ul style="list-style-type: none"> – “Jogging”, “Control” mode during the movement up to standstill after cancelation of R+, R- – Reference-point approach mode, during approach until reference point is reached – MDI, Incremental relative mode, during the positioning process or while functions of the MDI block are being processed – Automatic mode, during processing of a traversing program until the end of the program. • “Processing in progress” is deleted: <ul style="list-style-type: none"> – by errors and restarts – by mode changes. – after axis standstill
WAIT_EI	WFG	Wait for external enable	<p>... takes effect only if a digital input has been parameterized by means of MD34 (see Section 9.8.1).</p> <p>Set: if the enable input has not yet been set or has been reset when a movement has been activated.</p>
DT_RUN	T-L	Dwell time in progress	<p>... only active in Automatic and MDI mode.</p> <p>As soon as a traversing block with a dwell time has been processed, (T-L) is output during the programmed time period.</p>
PR_BACK	PBR	Program processing in reverse	<p>... is set after a Start in Automatic mode if a program is being processed in reverse.</p>
MODE_OUT	BAR	Active mode	<p>The selected mode is not fed back until it is internally active. For a mode change, for example, a movement must be stopped before another mode can become active (does not apply to switching between Automatic and Automatic single-block modes).</p>
SYNC	SYN	Synchronism	<p>... module is synchronized (see Section 9.6.1)</p> <p>Required for axis motion in modes:</p> <ul style="list-style-type: none"> • Incremental Relative • MDI • Automatic
MSR_DONE	ME	End measurement	<p>... signals an executed measurement (see Section 9.3.10)</p>

Table 9-2 Checkback signals, continued

Symbol		Significance	Function
English	German		
GO_P	FR+	Travel plus	<p>... means the axis is traveling in the direction of increasing actual values or in the direction of frequency output “+” in Control mode</p> <p>... means the axis is traveling in the direction of decreasing actual values or in the direction of frequency output “-” in Control mode.</p> <ul style="list-style-type: none"> As soon as an active traversing movement is pending, the messages (FR+) or (FR-) are output depending on the traversing direction. They can only be pending as alternatives. “Travel Plus” or “Travel Minus” is actuated at the start of the acceleration phase and remains active until the axis comes to a standstill or the POS_ROD target area has been reached.
GO_M	FR-	Go_minus	
ST_SERVO	SRFG	Servo enable status	<ul style="list-style-type: none"> Feedback of servo enable status after single function has been activated See also Section 9.3.2 “Servo enable” See also Section 11.1, error reaction “Everything OFF”
FVAL_DONE	FIWS	Set actual value on-the-fly complete	<p>... set Actual value on-the-fly is executed.</p> <p>The signal is reset when “Set actual value on-the-fly” is activated (see Section 9.3.6).</p>
NUM_MF	MNR	M function number	M command 0 – 99
STR_MF	AMF	Change M function	<p>... is indicated simultaneously with the M function number.</p> <ul style="list-style-type: none"> If M functions are programmed in a traversing block, their output is signaled by setting “Change M function.” “Change M function” remains pending until: <ul style="list-style-type: none"> the specified time has expired, for time-controlled M functions the user has acknowledged, for acknowledgment-controlled M functions.

Table 9-2 Checkback signals, continued

Symbol		Significance	Function
English	German		
POS_RCD	PEH	Position reached, Stop ("PEH")	<ul style="list-style-type: none"> • When the preset target position is reached correctly, (PEH) is actuated, and remains in effect until the next axis movement. • (PEH) is actuated only in the following modes and cases: <ul style="list-style-type: none"> - Reference-point approach: If the reference point has been reached in full (including reference-point shift). - MDI, Incremental relative: If the preset position has been reached. - Automatic: If a traversing block has been positioned in full and the axis remains motionless until the next traversing movement. • It is not set if no synchronization is available yet.
ACT_POS	ACT_POS	Actual position	The firmware version V3.7.6 of the FM 353 positioning module in conjunction with the blocks of the "FM353_354" block library provides direct access to the actual value. This is stored in the checkback signals during the module cycle (2 ms) and read by the POS_CTRL block. In addition, as previously, the actual value is included as a DINT variable in the basic operating data read request.

9.1.3 General handling information

Overview

Before data/settings can be transferred to the FM 353, an operating mode must be active (e.g. “Jogging” mode = 1 and MODE = 1). That means that communication with the FM 353 has been initiated and the FM 353 has access to valid machine data.

Operating modes (codes)	Relevant control signals	Relevant checkback signals	Required data/settings
Jogging (01)	[R+], [R-], [STP], [AF], [OVERR], [BP] = 1 or 2	[BL], [SFG], [FR+], [FR-], [SYN], [WFG]	Speed levels 1, 2 (User DB, DBX38.0) Servo Enable (User DB, DBX34.0)
Control (02)	[R+], [R-], [STP], [AF], [BP] = 1 or 2	[BL], [SFG], [FR+], [FR-], [WFG]	Frequency levels 1, 2 (user DB, DBX38.1)
Reference point approach (03)	[R+], [R-], [ST], [STP], [AF], [OVERR]	[BL], [SFG], [FR+], [FR-], [WFG], [SYN], [PEH]	Servo Enable (User DB, DBX34.0)
Incremental relative (04)	[R+], [R-], [STP], [AF], [OVERR], [BP] = 1...100 for increment table or 254	[BL], [SFG], [FR+], [FR-], [WFG], [SYN], [PEH]	Speed levels 1, 2 (user DB, DBX38.0) Servo Enable (user DB, DBX34.0) Setpoint for incremental dimension (user DB, DBX34.2) (only if BP = 254; if BP is = 1 to 100, the relevant incremental dimensions must be parameterized)
MDI (06)	[ST], [STP], [AF], [QMF], [OVERR]	[BL], [SFG], [FR+], [FR-], [WFG], [SYN], [PEH], [AMF], [MNR], [T-L]	MDI block (user DB, DBX38.3) Servo Enable (user DB, DBX34.0)
Automatic (08) Automatic single block (09)	[ST], [SA], [EFG], [STP], [AF], [QMF], [OVERR]	[BL], [SFG], [FR+], [FR-], [WFG], [SYN], [PEH], [AMF], [T-L], [PBR], [MNR]	Program selection (user DB, DBX 39.5) (assuming that the relevant traversing program was parameterized) Servo Enable (user DB, DBX34.0)

Error condition:

- Reported via BF/FS – acknowledgement with BFQ/FSQ
- Reported via DF – acknowledgement with next correct data transfer
- Reported via diagnostic interrupt – acknowledgement with “Restart” (user DB, DBX37.5)

Hints to the user

Here are a few hints for starting a movement and about the response of the FM 353 to a change of the status of the S7-300 CPU:

It is assumed that the FM 353 has been parameterized correctly.

- First a mode must be set. The servo enable must subsequently be set in order to prevent the axis from “running away.”
- Before starting a movement in any mode, the relevant data (e.g. speed levels) must be transferred and the override must be > 0.
- It is only possible to start the movement when the start enable is set and the enable input is set (if parameterized).

Enable Start is set if:

- No error occurred
 - Mode is active
 - No Stop is called
 - Drive enable is set
- A static Stop signal prevents all movements or block processing.
 - Response of the FM 353 to transition of the S7-300 CPU from RUN to STOP state:
 - As described for Restart (see Section 9.3.3)
 - The digital outputs are switched off
 - Interface to the user program is switched off
 - Response of the FM 353 to transition of the S7-300 CPU from STOP to RUN state:

A cold restart of the module is executed.

Module control

The following table lists the control signals used to start a movement.

Prerequisite: Drive enable [AF] = 1, Stop [STP] = 0,
Start enable [SFG] = 1

Mode (BA)	Parameters	Command / Signal state	Activation of movement
Jogging (mode = 01)	Velocity level BP = 1 = level 1 BP = 2 = level 2	R+, R- / Level	R+ or R- with "Level" = 1 (R+ and R- simultaneously → error)
Control (mode = 02)	Frequency level BP = 1 = level 1 BP = 2 = level 2	R+, R- / Level	R+ or R- with "Level" = 1 (R+ and R- simultaneously → error)
Reference point approach (mode = 03)	-	Start, R+, R- / Edge	Direction as in MD R+ or R- = 0/1 or Start = 0/1 (speed as in MD)
Incremental relative (mode = 04)	BP = 1...100 BP = 254	R+, R- / Edge	R+ = 0/1 or R = 0/1 (speed level 1)
MDI (mode = 06)	-	Start / Edge	Start = 0/1 (R+, R- relevant only for rotary axis with absolute measure specified for direction selection)
Automatic (mode = 08)	-	Start / Edge	Start = 0/1 (according to program presetting)
Automatic single block (mode = 09)	-	Start / Edge	Start = 0/1

Stat. pending start condition

"Processing in progress" remains active after the end of machining and there is no start enable as long as the start condition is not reset.

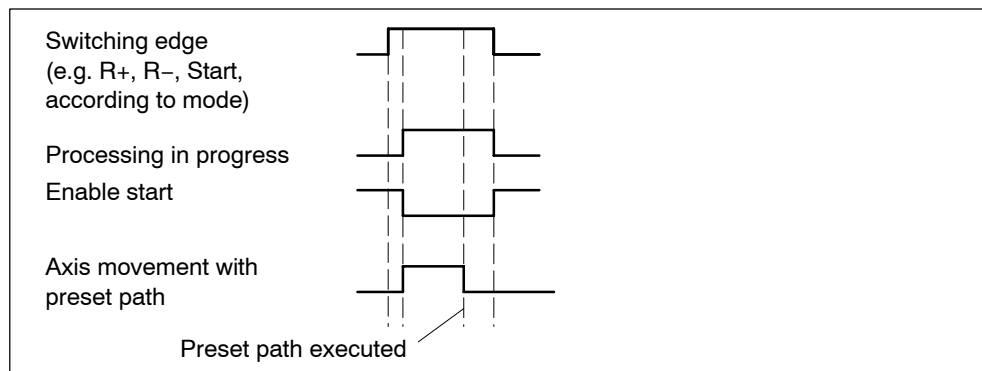

The following table lists the control signals used to interrupt/terminate a movement.

Mode (BA)	Interrupt movement	Continue movement	Interrupt/end movement, Stop
Jogging (mode = 01)	Stop = 1 or Enable input ¹⁾ = 0	Stop = 0 or Enable input ¹⁾ = 1	R+ or R- with "Level" = 0 or mode change Drive enable = 0 ²⁾
Control (mode = 02)	Stop = 1 or Enable input ¹⁾ = 0	Stop = 0 or Enable input ¹⁾ = 1	R+ or R- with "Level" = 0 or mode change Drive enable = 0 ²⁾
Reference point approach (mode = 03)	–	–	Stop = 0/1 or ref. received or mode change or enable input ¹⁾ = 0 Drive enable = 0 ²⁾
Incremental relative (mode = 04)	Stop = 1 or Enable input ¹⁾ = 0	Stop = 0 or Enable input ¹⁾ = 1, with R+ or R-	Position reached or mode change Drive enable = 0 ²⁾
MDI (mode = 06)	Stop = 1 or Enable input ¹⁾ = 0	Stop = 0 or Enable input ¹⁾ = 1, with Start = 0/1	Position reached or "block" processed or mode change Drive enable = 0 ²⁾
Automatic (mode = 08)	Stop = 1 or Enable input ¹⁾ = 0	Stop = 0 or Enable input ¹⁾ = 1, with Start = 0/1	Program end or mode change New program selected after stop Drive enable = 0 ²⁾
Automatic single block (mode = 09)	Stop = 1 or Enable input ¹⁾ = 0	Stop = 0 or Enable input ¹⁾ = 1, with Start = 0/1	Program end or mode change New program selected after stop Drive enable = 0 ²⁾

- 1) **Prerequisite:** Digital input defined in MD34; see Section 9.8.1
 2) if MD37.15 not defined, see Table 9-1 Control signal [AF]

9.2 Operating modes

Overview

The following operating modes are implemented on the FM 353:

- Jogging (ER) Code 01
- Open-loop control (STE) Code 02
- Reference point approach (REF) Code 03
- Incremental relative (SMR) Code 04
- MDI (Manual Data Input) Code 06
- Automatic (A) Code 08
- Automatic single block (AE) Code 09

Selecting the mode

By calling POS_CTRL, the mode (coding) entered by the user program in the user data block is called to transfer the operating mode (code) to the FM 353.

The axis is controlled by enabling and disabling appropriate control signals.

Checkback signal for mode

When the specification is allowed, the FM 353 feeds back the specified mode to the user program. If this checkback mode matches the specified one, the mode is active.

Changing modes

Changing modes triggers an internal stop.

If a mode change is attempted while a traversing movement is in progress, the modes are not switched until the axis comes to a stop. The mode checkback is performed after the movement in the old mode is completed.

This does not apply to changes between Automatic and Automatic Single-Block mode.

9.2.1 Jogging

Overview

In Jogging mode, axis traversing movements are specified by way of the direction keys (R+ or R-) and by speed.

Velocity

Before the axis can be moved, speeds (velocities) 1 and 2 must first be transferred to the FM 353 (user DB, DBX38.0).

You can choose between two mutually independent velocities (level 1 and level 2) with the mode parameter (BP).

The velocity can also be controlled using the override, and can be changed during the movement.

Name	Lower input limit	Upper input limit	Unit
Speed	10	500 000 000	MSR/min

MSR stands for measurement system raster (see Section 5.3.1)

Handling by the user

The table below gives you an overview of how to handle this mode.

Triggering of movement, Direction (R)	level selection	Speed
R+ or R- "level-controlled"	BP = 1	Value for speed level 1
	BP = 2	Value for speed level 2

Note

Please see also Section 9.1.3!

Control actions

Preconditions:

- The FM 353 has been initialized.
- The mode has been selected and acknowledged.
- Drive Enable [AF] = 1 (control signal in user DB, DBX15.7)
- Stop [STP] = 0 (control signal in user DB, DBX15.1)
- Servo Enable (RF) = 1 (user DB, DBX34.0)
- Speed levels have been transferred.

Table 9-3 Control actions for “Jogging” mode (examples)

Signal name	Level	Explanation
Control action 1, enable “Jogging” mode		
Control signal: Mode [BA]		The user initiates a [BA] command.
Checkback signals: Active mode [BAR]		The module returns [BAR] and [SFG].
Start enable [SFG]		
Control action 2, move axis – positive direction		
Control signals: Direction plus [R+]		When [SFG] and [AF] are active, [R+] is actuated.
Drive enable [AF]		The axis cancels the [SFG] and outputs messages [BL] and [FR+]
Checkback signals: Travel plus [FR+]		
Start enable [SFG]		
Processing in progress [BL]		
Processing in progress [BL]		
Control action 3, deactivate axis – positive direction		
Control signal: Direction plus [R+]		[R+] is canceled
Checkback signals: Travel plus [FR+]		When the axis has come to a standstill, the [BL] and [FR+] messages are canceled and [SFG] is activated. Before the axis comes to a standstill, it is possible to define a new direction “through start”.
Start enable [SFG]		
Processing in progress [BL]		
Processing in progress [BL]		
Control action 4, move axis – negative direction		
Control signals: Direction minus [R-]		[R-] is actuated in combination with velocity level 2.
Velocity level [BP]		The axis travels at velocity level 2, and returns [BL] and [FR-]. The [SFG] signal is canceled.
Checkback signals: Travel minus [FR-]		
Processing in progress [BL]		
Processing in progress [BL]		
Control action 5, switch over set-up velocity		
Control signal: Velocity level [BP]		A switchover from [level 2 to level 1] causes a dynamic transition between velocity levels 1 and 2.

Table 9-3 Control actions for “Jogging” mode (examples), continued

Signal name	Level	Explanation
Control action 6, ambiguous direction command (special situation)		
Control signals: Direction plus [R+] Direction minus [R-] Checkback signals: Travel minus [FR-] Processing in progr. [BL] Start enable [SFG] Operator/travel error [BF/FS]		[R+] is actuated while the axis is traversing with [R-]. The ambiguous direction command causes the axis to stop and [BF/FS] to be output. [FR-] and [BL] are reset. Only when [R+] is canceled and the error is acknowledged [BFQ/FSQ] is [SFG] actuated again and a new direction command can be initiated.
Control action 7, cancel drive enable (special situation)		
Control signal: Drive enable [AF] Checkback signals: Travel minus [FR-] Processing in progr. [BL]		[AF] is deactivated during the traversing movement. The axis is stopped immediately. [FR-] and [BL] are canceled.
Control action 8, reset during axis motion (special situation)		
Single command “Restart”, (DBX37.5) Checkback signals: Travel plus [FR+] Processing in progr. [BL]		Restart is defined during the traversing movement. The axis is stopped immediately. [FR+] and [BL] are cleared.
Control action 9, change direction		
Control signal: Direction plus [R+]		Only when [R+] is canceled is [SFG] reactivated.
Control action 10, change mode		
Control signal: Mode [BA]		A new [BA] 1 is preselected during the traversing movement. The axis is stopped. [FR+] and [BL] are deleted.

9.2.2 Open-loop control

Overview

In the “Control” mode, a frequency with selectable magnitude is specified and then used to perform a controlled movement. The direction of movement is determined by way of direction keys (R+ or R-).

The actual value of the axis is updated at the same time.

Note

A closed-loop controller, which may have been activated by a servo enable, is interrupted while the frequency is being output. After the Jogging signals R+ or R- have died off, servo control is referred to the new actual value, and reinstated after the axis comes to a stop, if the servo controller enable is still active when the axis stops.

Frequency values

The frequency is specified in the user DB, DBX38.1.

You can choose between two mutually independent frequency levels (level 1 and level 2) with the mode parameter (BP).

Name	Lower input limit	Upper input limit	Unit
Frequency	0	200 000	Hz

The values of the frequency levels can be altered during movement.

Handling by the user

The table below gives you an overview of how to handle this mode.

Triggering of movement, Direction (R)	Level selection	Speed
R+ or R- “level-controlled”	BP = 1	Value for frequency level 1
	BP = 2	Value for frequency level 2

Note

Please see also Section 9.1.3!

Control actions

The control and checkback signals are handled in the same way as in “Jogging” mode.

9.2.3 Reference point approach

Overview

In Reference-point approach mode, the direction keys (R+ or R-) or Start are used to position the axis to a point (reference-point coordinate MD16) specified in the machine data.

The axis is thus synchronized (see Section 9.6.1).

The override is set at 100% for the reducing speed.

An active zero offset or Set actual value is reset.

Machine data

The following table lists the machine data that is of significance for reference-point approach:

MD	Designation	Value/Meaning	Comments/Unit
16	Reference-point coordinate	-1,000,000,000 – +1,000,000,000	[MSR]
18	Type of reference-point approach	0 = direction +, current-sourcing pattern zero/ zero pulse external, to right of reference point switch 1 = direction +, current-sourcing pattern zero/ zero pulse external, to left of reference point switch 2 = direction -, current-sourcing pattern zero/ zero pulse external, to right of reference point switch 3 = direction -, current-sourcing pattern zero/ zero pulse external, to left of reference point switch 4 = direction +, reference point switch center 5 = direction -, reference point switch center 8 = direction +, reference point switch edge 9 = direction -, reference point switch edge	
27	Reference-point shift	-1,000,000,000 – +1,000,000,000	[MSR]
28	Referencing speed	10 – v _{max} (MD23)	[MSR/min]
29	Reducing speed	10 – x (see Machine data list, Table 5-4)	[MSR/min]
34	Inputs	5 = reference point switch for reference point approach 6 = reversing switch for reference point approach	Assigned depending on input

MSR stands for measurement system raster (see Section 5.3.1)

Handling by the user

- with connected reference-point switch (RPS).
- without connected reference-point switch (RPS).

With reference point switch (RPS)

It is necessary to connect the reference point switch (RPS) to a digital input and parameterize it in MD34.

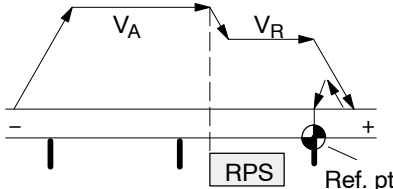
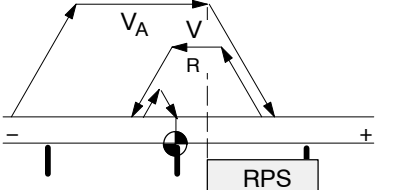
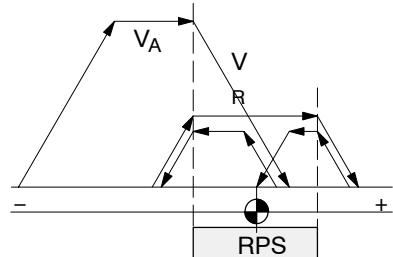
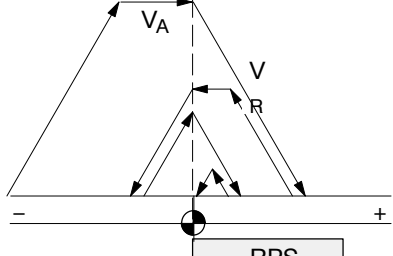
Triggering of movement, direction for synchronization (R)	Type of reference-point approach	Sequence of motions (reference point offset = 0) V_A – referencing velocity V_R – reducing velocity
R+ (“edge-controlled”) or Start	1st situation Current-sourcing pattern zero or zero pulse external, to right of RPS	
	2nd situation Current-sourcing pattern zero or zero pulse external, to left of RPS	
	3rd situation RPS centered (no zero pulse necessary)	
	4th situation RPS edge (no zero pulse necessary)	
R- (“edge-controlled”) or Start	1st situation see above	equals R+ 2nd situation mirrored
	2nd situation see above	equals R+ 1st situation mirrored
	3rd situation RPS centered (no zero pulse necessary)	equals R+ 3rd situation mirrored
	4th situation RPS centered (no zero pulse necessary)	equals R+ 4th situation mirrored

When crossing the RPS, a signal length of $\Delta t \geq 2 \cdot \text{FM cycle}$ must be assured!

The following table shows you the exact location of the synchronization point on the current-sourcing pattern zero or zero pulse external.

Synchronization point encoder Selection in MD37	Applicable for type (0 – 3) of the reference point approach per MD18
Current-sourcing pattern zero	
Zero pulse external (NIX)	

Using a reversing switch

If it is possible for the axis to be “behind” the reference point switch when you start reference point approach, a reversing switch can be installed at the end of the axis in the approach direction, in order to reverse the axis in the direction of the reference point switch.

On axis movements with referencing feed, a signal length of $\Delta t \geq 2 \cdot \text{FM cycle}$ must be assured for the reversing switch!

Example

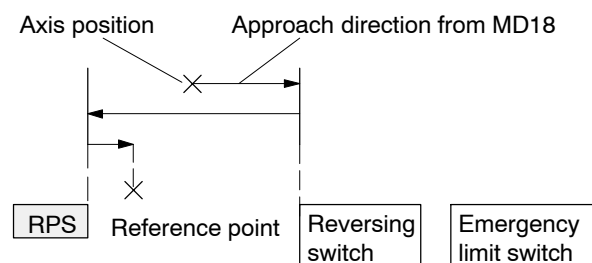

The value for the reference-point shift (MD27) is traveled after the synchronization point is reached.

Without reference-point switch (RPS)

The following table describes how a reference can be recorded without a reference-point switch.

Recording of synchronization	Sequence of movements
R+, R- or Start	<ol style="list-style-type: none"> 1. Instantaneous position is defined as reference point (reference-point coordinate). 2. Value for reference-point shift is traveled.

Note

Please see also Section 9.1.3!

Control actions

Preconditions:

- The FM 353 has been initialized.
- The mode has been selected and acknowledged.
- Drive Enable [AF] is = 1 (control signal in the user DB, DBX15.7)
- Stop [STP] = 0 (control signal in the user DB, DBX15.1)
- Servo Enable (RF) is = 1 (user DB, DBX34.0)

Table 9-4 Control actions for “Reference point approach” mode (examples)

Signal name	Level	Explanation
Control action 1, enable “Reference point approach” mode		
Control signal: Mode [BA]		The user initiates a [BA] command.
Checkback signals: Active mode [BAR]		The module returns [BAR] and [SFG].
Start enable [SFG]		
Control action 2, move axis – positive direction		
Control signal: Direction plus [R+]		When [SFG] is active, [R+] or [Start] are actuated, for example.
Checkback signals: Travel plus [FR+]		The axis cancels [SFG], outputs the [BL] and [FR+] messages and travels here in the positive direction (defined in MD).
Start enable [SFG]		An existing synchronization is reset.
Processing in progr. [BL]		
Synchronization [SYN]		

Table 9-4 Control actions for “Reference point approach” mode (examples), continued

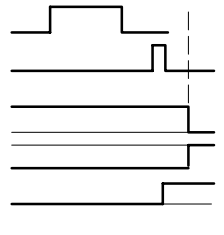
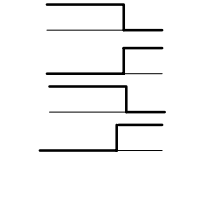
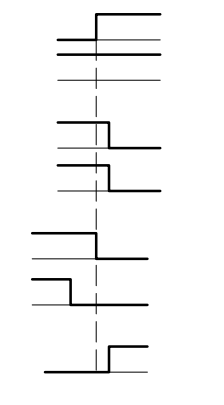
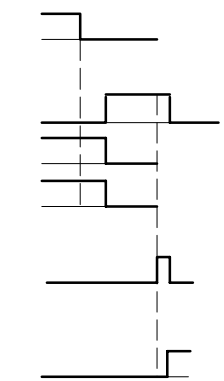
Signal name	Level	Explanation
Control action 3, reference point switch (RPS) reached		
RPS Encoder zero marker Checkback signals: Travel plus [FR+] Travel minus [FR-] Synchronized [SYN]		When the RPS is reached, the velocity is reduced. The encoder is synchronized when the zero marker is detected. The axis is positioned by traversing through the reference point offset to the reference point (the direction is reversed if necessary).
Control action 4, approach reference point		
Checkback signals: Travel minus [FR-] Position reached, stop [PEH] Processing in progress [BL] Start enable [SFG]		When reference point is reached. [FR-] is removed. [PEH] is set. [BL] is also removed. [SFG] is set.
Control action 5, ambiguous direction command (special situation)		
Control signals: Direction plus [R+] Direction minus [R-] Checkback signals: Travel minus [FR-] Processing in progress [BL] Control signals: Direction plus [R+] Direction minus [R-] Checkback signal: Start enable [SFG]		[R+] is defined although [R-] is active. The ambiguous direction command causes the axis to stop. [FR-] and [BL] are canceled, and an error is output. The [SFG] does not reappear until [R+] and [R-] have been canceled].
Control action 6, cancel servo enable (special situation)		
Single function “Servo Enable” (DBX34.0) Checkback signals: Oper./travel error [BF/FS] Travel minus [FR-] Processing in progr. [BL] Control signal: Acknowledge operator/travel error [BFQ/FSQ] Checkback signals: Start enable [SFG]		The “servo enable” is deactivated during the traversing movement. The axis is stopped immediately and outputs an error. [FR-] and [BL] are canceled. When the error is acknowledged, the error message is canceled and the start enable is activated.

9.2.4 Incremental relative

Overview

In the Incremental Relative mode it is possible to execute single positionings over relative distances using user-definable increments.

The traversing movement is triggered with the direction keys (R+ and R-).

Defining the position

The options available for defining the increment with the mode parameter are:

- Via the user program by defining a position for incremental mode (user DB, DBX38.2)

The setpoint for the incremental dimension must be entered in the AW-DB, DBD156, before the write order is initiated.

- Using the increment table; see Section 5.3.2

Speed level 1 (user DB, DBX38.0, see Section 9.2.1) is used as speed setpoint, and can be modified while the movement is in progress.

On-the-fly position changes (e.g. changing of the position setpoint during the course of a movement) is **not** possible.

Handling by the user

The table below gives you an overview of how to handle this mode.

Triggering of movement, Direction (R)	Increment selection	Position, Distance to be traveled
R+ or R-	BP = 254	in accordance with the setpoint for incremental dimension (user DB, DBX38.2)
	BP = 1...100	as in SM table (DB-SM)

Position setting

Name	Lower input limit	Upper input limit	Unit
Increment	0	1 000 000 000	MSR

MSR stands for measurement system raster (see Section 5.3.1)

Note the following when interrupting a movement with "Stop":

- To continue movement in the same direction - the residual distance is processed with the appropriate direction key.
- To continue movement with "delete distance to go" (user DB, DBX37.1), the remaining distance to go is deleted and the incremental dimension is again traveled (provided the incremental dimension was not changed).
- To position in the opposite direction - the residual distance is deleted automatically.

Note

Please see also Section 9.1.3!

Control actions

Prerequisites:

- The FM 353 has been initialized.
- The mode has been selected and acknowledged.
- The Drive Enable [AF] = 1 (control signal in the user DB, DBX15.7)
- Stop [STP] = 0 (control signal in the user DB, DBX15.1)
- The Servo Enable (RF) = 1 (user DB, DBX34.0)
- Speed levels have been transferred.
- The axis is synchronized.

Table 9-5 Control actions for “Incremental relative” mode (examples)

Signal name	Level	Explanation
Control action 1, enable “Incremental relative” mode		
Control signal: Mode [BA]		The user initiates a [BA] command.
Checkback signals: Active mode [BAR]		The module returns [BAR] and [SFG].
Start enable [SFG]		
Control action 2, define position		
Transfer incremental dimension (DBX38.2) Select increment (254)		When the incremental dimension has been transferred and selected, [R+] can be specified.
Control signal: Direction plus [R+]		The axis cancels the [SFG] and outputs messages [BL] and [FR+]
Checkback signals: e.g. Travel plus [FR+]		
Start enable [SFG]		When the defined position has been reached, the axis enables [PEH]; [SFG] and checkback signals [FR+] and [BL] are reset.
Processing in progress [BL]		
e.g. Travel plus [FR+]		
Processing in progress [BL]		
Position reached, stop [PEH]		

Table 9-5 Control actions for “Incremental relative” mode (examples), continued

Signal name	Level	Explanation
Control action 3, stop during positioning		
Control signal: Stop [STP]		If Stop is enabled during positioning, the axis stops. [FR-] is reset, and [SFG] is activated. [PEH] is not output, since positioning is not complete.
Checkback signals: Travel minus [FR-]		Before the axis comes to a standstill, it is possible to define a new direction “through start”.
Start enable [SFG]		
Control action 4, error during traversing movement		
Checkback signals: Travel plus [FR+]		The axis moves.
Processing in progress [BL]		An error is output during the traversing movement. [FR+] and [BL] are canceled, and [BFQ/FSQ] is enabled.
Control signal: Acknowledge operator/travel error [BFQ/FSQ]		When the error has been acknowledged, the start enable is activated. The movement can be restarted with [R+].
Checkback signals: Start enable [SFG]		
Control signal: Direction plus [R+]		
Checkback signals: Travel plus [FR+]		[FR+] and [BL] are activated. [SFG] is canceled.
Processing in progress [BL]		
Control action 5, change mode		
Control signal: Mode [BA]		[BA] is deactivated during the traversing movement.
Checkback signals: Active mode [BAR]		The axis is stopped. [FR+] and [BL] are deleted.
Travel plus [FR+]		
Processing in progress [BL]		

9.2.5 MDI (Manual Data Input)

Overview

In the MDI mode it is possible to execute single positionings by way of traversing blocks. These traversing blocks are provided by the user program.

The MDI block and MD block on-the-fly have an identical block structure.

MDI block

The structure of the MDI block is identical to that of the traversing blocks (see Chapter 10 resp. Section 9.3.12) except that it has neither a program number nor a block number.

The user program passes the “MDI block” (user DB, DBX38.3) to the FM 353, and the block can then be executed. The block can be executed repeatedly, since it is stored internally. The feedrate is override-dependent.

The MDI block remains in effect until it is overwritten with a new MDI block. A new block can be transmitted while another block is being processed.

Table 9-6 MDI block (see Chapter 10 for command structure)

Name	Lower input limit	Upper input limit	Unit
Position X / Dwell time t	-1,000,000,000 2	+ 1,000,000,000 100,000	MSR from MD7 ms
Speed F	10	500 000 000	MSR from MD7/min
G function group 1	G04 G90 G91	Dwell time Absolute dimensions Incremental dimensions	-
G function group 2	G30 100% G31 10% G39 90%	} Override Acceleration/ Deceleration	-
M function group 1, 2, 3	M1 – 17 M19 – 96 M99 M97, 98 M2, M30	} User functions Change signal programmed as digital output Not allowed	-

MSR stands for measurement system raster (see Section 5.3.1)

For rotary axes with absolute programming, the commands [R+], [R-] are defined as direction commands. They must be available before positioning starts.

MDI block on-the-fly

The MDI block currently being processed is canceled when the user program outputs an “MDI block on-the-fly” (user DB, DBX38.4).

Transfer of “MDI block on-the-fly” interrupts the active “MDI block”. The new block is executed immediately without “Start”.

The MDI block on-the-fly is **not** saved in the FM 353.

With software version 3.6 of the FM 353 and higher, the error “Data cannot be accepted at the time of transfer” (Class 4/No.1) is signaled when “MDI block flying” is provided and [BL] has already been reset or [PEH] =1.

Block structure

The following table shows the block structure of the MDI block.

X/t Position/dwell time programmed (fills in value 1)
 G1 – G2 G function group 1 – 2
 M1 – M3 M function group 1 – 3
 F Speed programmed (fills in value 2)

Example ¹⁾	Byte	Data format	Bit							
			7	6	5	4	3	2	1	0
0	0	Byte	0							
0	1	Byte	0							
Bits 0, 1, 4 set	2	8 x bits	0	0	0	X/t	0	0	G2	G1
Bit 0 set	3	8 x bits	0	0	0	0	M3	M2	M1	F
90	4	Byte	G function 1							
30	5	Byte	G function 2							
0	6	Byte	0							
0	7	Byte	0							
100,000	8	DINT	32-Bit-value 1							
5,000	12	DINT	32-Bit-value 2							
0	16	Byte	M function 1							
0	17	Byte	M function 2							
0	18	Byte	M function 3							
0	19	Byte	0							
1) Traversing block with absolute dimensions (G90), an end position of 100,000 DSG as per MD7, and a speed of 5,000 DSG/min.										

Note:

When the assignment bit (byte 2 and byte 3) is not set, the associated values must be deleted.

Handling by the user

The table below gives you an overview of how to handle this mode.

Triggering of movement	Type of movement
Start	as defined by "MDI block" (user DB, DBX38.3)
"MDI block on-the-fly" transmitted to the FM 353	as defined by "MDI block on-the-fly" (user DB, DBX38.4)

Note

Please see also Section 9.1.3!

Control actions

Prerequisites:

- The FM 353 has been initialized.
- The mode has been selected and acknowledged.
- Drive Enable [AF] is = 1 (control signal in user DB, DBX15.7)
- Stop [STP] is = 0 (control signal in user DB, DBX15.1)
- Servo Enable (RF) is = 1 (user DB, DBX34.0)
- Axis is synchronized.

Table 9-7 Control actions for "MDI" mode (examples)

Signal name	Level	Explanation
Control action 1, define position		
Transfer MDI block (DBX38.3) Control signal: Start [ST]		When the MDI block has been transferred, [ST] can be initiated.
Checkback signals: e.g. Travel plus [FR+] Start enable [SFG] Processing in progr. [BL]		The axis cancels the [SFG] and outputs messages [BL] and [FR+]
e.g. Travel plus [FR+] Processing in progr. [BL] Position reached, stop [PEH]		When the defined position has been reached, the axis enables [PEH]; [SFG] and checkback signals [FR+] and [BL] are reset.

Table 9-7 Control actions for “MDI” mode (examples), continued

Signal name	Level	Explanation
Control action 2, change position during positioning		
Transfer MDI block on-the-fly (DB38.4) Checkback signals: Travel plus [FR+] Travel minus [FR-]		If a new “MDI block on-the-fly” is transferred during positioning, the current positioning operation is canceled immediately, and the new positioning operation is started on-the-fly. In this case, for example, this causes the direction to be changed from [FR+] to [FR-].
Control action 3, stop during positioning with new start signal for resumed positioning		
Control signal: Stop [STP] Checkback signals: Travel minus [FR-] Start enable [SFG]		If Stop is enabled during positioning, the axis stops. [FR-] is reset, and [SFG] is activated. [BL] remains active and [PEH] is not output, since positioning is not complete.
Control signal: Start [ST] Checkback signals: Travel minus [FR-] Start enable [SFG]		If [ST] is initiated again, [FR-] and [SFG] are reset and positioning is completed. Before the axis comes to a standstill, it is possible to define a new direction “through start”.
Control action 4, stop during positioning with new start signal and new MDI block		
Control signal: Stop [STP] Checkback signals: Travel plus [FR+] Start enable [SFG] Transfer MDI block (job no. 6) Transfer “delete residual path” (job no. 11)		If Stop is enabled during positioning, the axis stops. [FR+] is reset, and [SFG] is activated.
Control signal: Start [ST] Checkback signals: Travel minus [FR-]		When a new MDI block has been transferred, [ST] is enabled again. “Delete residual path” is also enabled. The axis deletes the residual path of the old positioning operation, and starts executing the new traversing block.
		[FR-] is enabled, and [SFG] is reset. Note: If no new “MDI block” is transferred, execution of the current “MDI block” is repeated from the start. Without “delete residual path”, the interrupted positioning operation would be continued (see control action 3)

9.2.6 Automatic

Overview

In the Automatic mode (following-block mode), the FM 353 processes traversing programs autonomously. These programs are created with "Parameterize FM 353" (see Chapter 5, 5.3.4) and stored as a data block. The traversing programs contain information about movement sequences and outputs (see Chapter 10).

Program selection

Programs are selected (user DB, DBX39.5) by way of the user program, by specifying a program number and an optional block number, as well as the direction of machining. A program can be selected only when other programs have been interrupted or terminated or at the start of a program.

A selected program remains active until it is inactivated by selecting program number = 0, or overwritten by selecting another program.

If modifications are made to a preselected program, including the subprogram, preselection of the program is canceled. You must then select the program again. A modification can be made to a program when BL = 0 (start of program/end of program) and on Stop.

Triggering of movement	Select program		Type of movement (according to programmed blocks)
	Block No.	Processing direction	
Start	0	forward	Start at beginning of program, process by ascending block number
	0	reverse	Start at end of program, process by descending block number
	e.g. 30	forward	Block search forward to block No. 30, by ascending block number
	e.g. 30	reverse	Block search in reverse to block No. 30, by descending block number
Start with automatic block search forward		forward	<ol style="list-style-type: none"> 1. Automatic block search forward to interruption point 2. Positioning to interruption point (if a movement was performed in another mode) 3. Process the interrupted block and continue the program
Start with automatic block search in reverse		reverse	<ol style="list-style-type: none"> 1. Automatic block search in reverse to interruption point 2. Positioning to interruption point (if a movement was performed in another mode) 3. Process the interrupted block and continue the program

User DB allocation

Data format	Significance
Byte 0	Program number
Byte 1	Block number
Byte 2	Direction of machining: 0 = process forward 1 = process in reverse

Forward processing

The program processes the block numbers in ascending order.

Processing begins at Start, with the first block (specified block number = 0).

If processing is to begin at some other point of the traversing program, specify the desired block number.

Processing will take place by searching forward to this block, then processing forward until the program end command is recognized.

Backward processing

The program processes the block numbers in descending order.

Processing begins at Start, with the last block (specified block number = 0).

If processing is to begin at some other point of the traversing program, specify the desired block number. Processing will take place by searching back to this block, then processing in reverse until the program beginning is recognized.

Note

If reverse processing is to execute the same sequence of movements as the forward movement, the effects of the corresponding commands must be taken into account in the programming. For example:

- M outputs should be written separately in a block; note M output (MD32) and G60/G64.
 - Note change between G60/G64 and G90/G91.
 - Note start and end of tool offsets.
 - M18 is not executed.
 - M02 and M30 at the end of the program are not processed.
-

Block advance

The program is prepared up to the end point of the target block; the tool offset, M commands and dwell times are output; and the traversing movements are suppressed.

When processing traversing programs with a forward block search, there are a number of special cases:

- The external forward block search (G50) is not executed.
- Continuous travel with functions to set (G88, 89) or delete (G87) an actual value on-the-fly is not executed.
- The blocks under G50, G87, G88, G89 (in the processing direction) should contain a path in absolute coordinates.

Block return

Similar to block advance

Automatic block advance/return

Automatic block advance/return means that, after the interruption of an active automatic program (by an operating mode change), you can continue execution from this point of interruption in the appropriate direction of processing.

With forward block search, the interrupted program must previously have been going in the forward direction.

With block search in reverse, the interrupted program must previously have been going in the reverse direction.

The command for automatic forward or reverse block search is evaluated in the FM 353 at Start, and a forward or reverse block search to the interruption point is executed in the "Jog" mode at the velocity of stage 1. Positioning to the interruption point takes place (if positioning has taken place previously in some other mode), and then the interrupted block is processed, including any required output.

Control actions

Prerequisites:

- The FM 353 has been initialized.
- The mode has been selected and acknowledged.
- Drive Enable [AF] is = 1 (control signal in user DB, DBX15.7)
- Stop [STP] is = 0 (control signal in user DB, DBX15.1)
- Servo Enable (RF) is = 1 (user DB, DBX34.0)
- Axis is synchronized.

Table 9-8 Control actions for “Automatic” mode (examples)

Signal name	Level	Explanation
Control action 1, Automatic/Automatic single block mode		
Control signals: Mode [BA] Read-in enable [EFG]		The user initiates [BA] and [EFG]. The module returns [BAR] and [SFG].
Checkback signals: Active mode [BAR] Start enable [SFG]		
Control action 2, positioning by program selection		
Program selection (DBX39.5) Control signal: Start [ST]		When [SFG] appears, the program can be activated by [ST] when [EFG] is active.
Checkback signals: Travel plus [FR+] or Travel minus [FR-] Start enable [SFG] Processing in progress [BL]		
Control action 3, M function output		
Checkback signals: Change M function [AMF] M function number [MNR]		If M function output is acknowledgement-driven, for example, the user program can continue to process the [MNR] when [AMF] appears.
Control signal: Acknowledge M function [QMF]		
Control action 4, M function output and positioning		
Control signal: Acknowledge M function [QMF]		Block with M output (same as control action 3) and position is started.
Checkback signals: Position reached, stop [PEH] Travel plus [FR+] or Travel minus [FR-]		

Table 9-8 Control actions for “Automatic” mode (examples), continued

Signal name	Level	Explanation
Control action 5, traversing block with dwell		
Checkback signals: Travel plus [FR+] or Travel minus [FR-] Dwell time running [T-L] Position reached, stop [PEH]		During processing of a traversing block with dwell, the dwell time t_0 [T-L] and [PEH] are output.
Control action 6, cancelation of the read-in enable during program execution (special situation)		
Control signal: Read-in enable [EFG]		If [EFG] is canceled during program execution, the current block is processed up to the end, and program execution is then suspended. [FR+] and [FR-] are reset. [PEH] is actuated.
Checkback signals: Travel plus [FR+] or Travel minus [FR-] Position reached, stop [PEH]		
Control action 7, resume program execution after read-in enable (special situation)		
Control signal: Read-in enable [EFG]		The program resumes on [EFG].
Checkback signals: Travel plus [FR+] or Travel minus [FR-] Position reached, stop [PEH]		[FR+] and [FR-] are reset. [PEH] is reset.
Control action 8, stop during positioning with new start signal for resumed positioning (special situation)		
Control signals: Stop [STP] Start [ST]		Interrupt with Stop [FR+] is cleared when the axis comes to a standstill, and [SFG] is enabled (if Stop is not active). [PEH] remains cleared, since the defined position has not yet been reached. Start clears [SFG] and enables [FR+] again. [BL] remains enabled. Before the axis comes to a standstill, it is possible to define a new direction “through start”.
Checkback signals: Position reached, stop [PEH] Travel plus [FR+] Start enable [SFG] Processing in progress [BL]		
Control action 9, end of program reached		
Checkback signals: Travel plus [FR+] or Travel minus [FR-] Processing in progr. [BL] Position reached, stop [PEH] M function number [MNR] Start enable [SFG]		The end of the program is indicated by the enabling of [PEH], output of M2, M30 and resetting of [BL].

Table 9-8 Control actions for “Automatic” mode (examples), continued

Signal name	Level	Explanation
Control action 10, delete start signal and residual path (special situation)		
Control signal: Start [ST] Transfer “delete residual path” (DBX37.1)		If “delete residual path” is also preselected on [ST], the block interrupted by Stop is not executed up to the end, but the next block is started immediately.
Control action 11, positioning for rotary axis (special situation)		
Control signals: Direction plus [R+] or direction minus [R-] Start [ST]		If the axis is operated as a rotary axis, the FM always attempts to select the shortest path during positioning. This direction preference can be suppressed by specifying [R+] or [R-].
Control action 12, deactivate operating mode during program execution (special situation)		
Control signal: Mode [BA]		If a new operating mode is selected during active program execution, the axis is stopped. [FR+] or [FR-] and [BL] are reset.
Checkback signals: Old mode [BAR]		
Travel plus [FR+] or Travel minus [FR-]		
Processing in progress [BL]		
New mode [BAR]		
Mode [BA]		

9.2.7 Automatic single block

Overview

Functions, same as “Automatic” mode

Whereas in “Automatic” mode the FM 353 automatically starts processing the next block after completing a given block, in “Automatic single-block” mode the axis waits for a new Start signal after processing each block that contains a traversing path, dwell time or M command (except for blocks with G50, G88 or G89).

You can change between Automatic single-block and Automatic mode at any time, without stopping the movement or interrupting the output.

9.3 System data

Overview

This chapter describes settings and functions that apply in multiple modes, and that are likewise necessary in order to control and operate the FM 353, and data of the FM available for checkback messages.

- Change parameters/data (Write request in user DB, DBX39.3), page 9-38
- Single functions (user DB, DBB34 and 35), page 9-42
- Single functions (user DB, DBB36 and 37), page 9-44
- Zero offset (Write request in the user DB, DBX39.1), page 9-46
- Set actual value (Write request in the user DB, DBX38.7), page 9-48
- Set actual value on-the-fly (Write request in the user DB, DBX39.0), page 9-49
- Request application data (Write request in the user DB, DBX39.6), page 9-50
- Teach in (Write request in the user DB, DBX39.7), page 9-51
- Set reference point (Write request in the user DB, DBX38.6), page 9-51
- Measured values, page 9-52
- Basic operating data (Read request in the user DB, DBX42.0), page 9-55
- Active NC block (Read request in the user DB, DBX42.1),
next NC block (Read request in the user DB, DBX42.2), page 9-56
- Application data (Read request in the user DB, DBX43.6), page 9-57
- Actual value block change (Read request in the user DB, DBX42.3), page 9-57
- Servicing data (Read request in the user DB, DBX42.4), page 9-57
- Additional operating data (Read request in the user DB, DBX43.5), page 9-58
- Parameters/data (Read request in the user DB, DBX43.3), page 9-58

9.3.1 Change parameters/data (Write request in user DB, DBX39.3)

Overview

You can use this function to modify parameters and data in the FM 353 data blocks or to define parameters and data which can then be read out with a Read request (user DB, DBX43.3) (see Section 9.3.17).

Structure of Write request

The following table shows which parameters or data can be changed or read by setting the indicated codes.

Addr. in user DB	Data format	Symbol	Description				
			type	1 = MD	2 = SM	3 = TO	4 = NC (traversing program)
196	Byte	DB type	type	1 = MD	2 = SM	3 = TO	4 = NC (traversing program)
197	Byte	Number	Info 1	MD No. (5 – 45)	SM No. (1 – 100)	TO No. (1 – 20)	Progr. No. (1 – 199)
198	Byte	Number	Info 2	Number of MDs, consecutive (1 – 5)	Number of SMs, consecutive (1 – 5)	0 = Tool offset complete 1 = Tool length only 2 = Wear value abs. only 3 = Wear value add. only	Block No. (1 – 255)
199	Byte	Job	1 = Read job parameters 2 = Write parameters 4 = Write parameters and save retentively ¹⁾				
200 – 219	depends on type	Data field	<ul style="list-style-type: none"> MD: Data format of machine data see Table 5-4 or SM: Data format of increments see Table 5-5 (DWORD) or WK: Data format of tool offset see Table 5-6 (DINT) or NC: Block format see Section 9.3.12 "Active NC block" 				

1) not with cyclic operation under 10 s

Example 1

The software limit switches (MD21, MD22) for the axis are to be set to the values 100 mm and 50,000 mm. These values are to remain in effect only until the unit is shut down.

DB type	= 1
Data number	= 21
Number of data	= 2
Job type	= 2
Data array	
Byte 200 –203	= 100,000 (MD21, data format DINT)
Byte 204 – 207	= 50,000,000 (MD22, data format DINT)
Bytes from 208 on	= 0

For activation of the machine data, see Section 9.3.3

Notes

Please note the following when changing the parameter data:

- **Machine data**

Machine data can always be modified. Once you have modified the machine data, the machine data have to be reactivated (for single command, see Section 9.3.3).

- **Increments**

Modifications can be made in all operating modes (even in “Incremental relative” mode) during movement. The modifications of the increments must always be complete before a new movement is started in “Incremental relative” mode. If this is not the case, the error message “incremental dimensions do not exist” is output Cl. 2/No. 13.

- **Tool offset data**

Modifications can be made in all operating modes and during movement. If modifications are made during starting or at block transitions when the tool compensation is active (internal access to offset values), the error message “tool offset value does not exist” is output Cl.3/No.35.

- **Traversing programs**

- Programs which are not selected can always be modified.
- If modifications are made to a preselected program, including the subprogram, preselection of the program is canceled. You must then select the program again. A modification can be made to a program when BL = 0 (start of program/end of program) and on Stop.

Delete block: Specify the program no. and the block no. in the “data field”.
The other data/bits must not be assigned.

Insert block: The block number does not exist in the selected program.
The contents should be entered in accordance with the “block format”.

Modify block: The block with the corresponding block number is overwritten with the contents in accordance with “block format”.

Example 2

Procedure for changing the actual value and the velocity in block 10 of traversing program 1.

1. Submit job request to read the block. Enter the following values in the user DB:
DB type = 4
Number = 1
Number of data = 10
Job type = 1
Data array = 0
2. Set Write request (user DB, DBX39.3).
3. Following termination of the Write request (one cycle later), read out the block by setting the Read request (user DB, DBX43.3).
4. Save the data read out from DBB 446 to 469 of the user DB in DBB196 to 219.
5. Enter the actual value in data array DBB208 to 211 in the user DB (data type DINT).
6. Enter the velocity in DBB212 to 215 of the user DB (data type DINT).
7. Enter a 4 in DBB199 of the user DB (request) (retentive storing of the block).
8. Set Write request (user DB, DBX39.3).

Retentive storage of parameter data

Please note the following when using the function "Write parameters with retentive storage" (byte 4, job type 4):

Retentive writing must only occur on demand (not cyclically)!

Retentive data are stored on FEPRAM (maintenance-free, no battery required). This memory has a physical limit for the possible number of delete/reprogram cycles: minimum 10^5 , typically 10^6 . The possible number of delete/reprogram cycles can be multiplied, from the user's viewpoint, by providing a larger retentive memory capacity (much larger than the parameter data memory) and organizing the memory accordingly.

$$\text{Number of delete/reprogram cycles} = \frac{64\,000 \cdot 10^6 \text{ (typical)}}{\text{Block size (in bytes), in which parameter data are modified}}$$

Block sizes:

DB machine data	284 bytes
DB increments	468 bytes
DB tool offset data	308 bytes
DB traversing programs	$108 + (20 \times \text{no. of traversing blocks})$ bytes

Example:

Assuming a service life of 10 years and 24-hour operation, a typical limit = 10^6 .

Parameterization data	DB size	Number of possible delete/reprogram cycles	Number of possible delete/reprogram cycles per minute
MD	284 bytes	$237.04 \cdot 10^6$	46
Traversing programs (20 blocks)	508 bytes	$125.49 \cdot 10^6$	24

Note

SDB \geq 1 000 (system data block, created for module replacement), contains parameter data which were valid at the time of start-up. If data/parameters are modified during operation and stored retentively on the FM, these data are not contained in SDB \geq 1 000. These modifications are lost when the module is replaced, and should be traceable in the user program.

9.3.2 Single functions (user DB, DBB34 and 35)

Overview

You can use this function to transfer single settings to the FM 353 and activate the corresponding functions. These settings are:

- Length measurement
- Inprocess measurement
- Retrigger reference point
- Switch off enable input
- Switch off software end position monitoring
- Servo enable
- Rotation monitoring
- Parking axis
- Simulation

Callup of single settings

The individual functions remain activated until they are reset.

Length measurement, in-process measurement

Since both functions use the same digital input on the FM 353, only one function can be executed at a time. In double activations, both functions are switched to inactive. An error message is issued.

For function description, see Section 9.3.10

Retrigger reference point

A precondition for retrigger reference point is that the axis has been synchronized by reference point approach.

With this setting, the axis resynchronizes upon overrunning the synchronization point when the direction of travel is the same as the direction of reference point approach. Regardless of the current speed, the reference point coordinates are allocated to the current actual position, taking into account any active shift.

When overrunning the reference point switch, a signal length of $\Delta t \geq 2 \cdot FM$ cycle must be ensured!

The resulting change in the actual value causes no internal changes in the target.

When a Set Actual Value On-the-Fly is pending, activation of Retrigger Reference Point is interlocked.

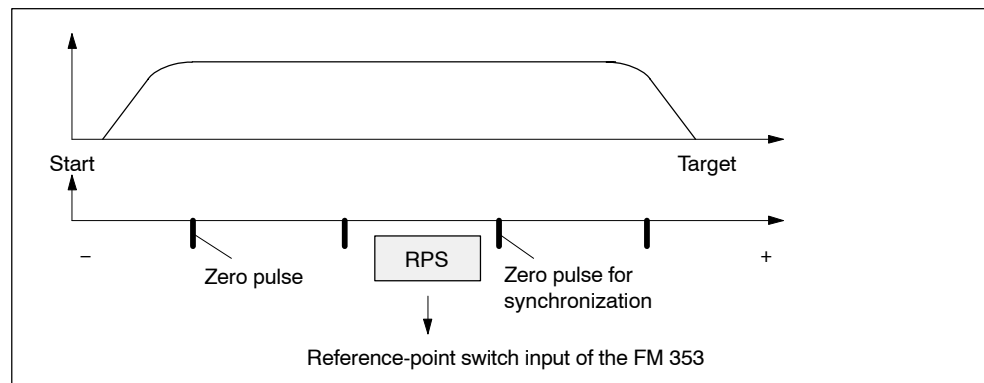
**Hint to the user:**

You can use Retrigger Reference Point, for example, to compensate for slippage of the trolley in a high-bay warehouse during operation, without having to resynchronize the axis with the Reference-Point Approach mode. When retriggering in reference point approach with a zero pulse, be careful that the total slippage between the reference point switch and the stepper motor does not become so great that the synchronizing zero pulse migrates to an “adjacent” zero pulse!

Switch off enable input

With the “switch off enable input” function, you can switch off evaluation of the enable input (see Section 9.8.1).

Deactivate end position monitoring

You can use this function to deactivate monitoring of the software limit switches (see Section 9.9).

It can be switched on or off only if “Processing in progress” = 0.

Rotation monitoring

Rotation monitoring is performed in all operating modes. It is automatically interrupted as the synchronization mark is passed in “Reference point approach” mode and in “Retrigger reference point” function.

The “rotation monitoring” function is described in Section 9.7.3.

Servo enable

You can use this function to:

- Activate the control function “Positioning”
- Switch the signal through to the drive as indicated in MD37

Parking axis

You can use this function to achieve the following:

- Pending error messages are deleted and no new ones are triggered (including diagnostic interrupts)
- Digital outputs are inactive

The setting can be switched on or off if “Processing in progress” = 0.

Simulation

You can use this function to:

- Test function sequences without the drive and measuring system.
A drive, if any connected, must be switched off.
- Evaluate all digital inputs (**Caution**, if you are going to simulate sequences that use such signals, they should be connected to the inputs of the FM 353 - e.g. for Reference-Point Approach).
- The servo simulates a controlled system; “Controller Ready” is not necessary.
- The setting can be switched on or off if “Processing in progress” = 0.
- All internal function sequences behave as in normal operation.

When the function is deactivated, the axis is reset internally (see Restart, Section 9.3.3).

9.3.3 Single commands (user DB, DBB36 and 37)

Overview

You can use this function to transfer single commands to the FM 353. These commands are:

- Activate machine data
- Delete residual distance
- Automatic block search in reverse
- Automatic block advance
- Restart
- Remove setting actual value

Callup of single commands

The single commands are activated when the corresponding data record is transmitted to the FM 353.

The commands are deleted in the FM 353 after execution.

Activate machine data

Once you have downloaded the machine data (MD) or the MD block (from the programming device), the machine data have to be activated. At the first parameterization, the machine data is transferred automatically. In terms of effects, the FM 353 distinguishes between “K” and “E” machine data.

MD category	Effect in FM 353 after activation
“K”	“Reset” of the FM <ul style="list-style-type: none"> • As long as “Reset” is in progress, it is not possible to transfer other data • For internal response, see Restart
“E”	FM operating condition is maintained

For machine data, see Section 5.3.1.

This command is possible only when the axis is not in motion (“Processing in progress” = 0). An operating mode must be selected.

An MD block is likewise activated by switching on or off.

Delete residual path

You can use this command to delete a residual distance that remains after a job has been canceled.

- Effective only in “Incremental Relative”, “MDI”, and “Automatic” modes after a stop (SFG = 1 and BL = 1). If processing is not interrupted with a stop, the “Delete Distance to Go” request is suspended in the FM 353.
- On starting after a Delete Residual Distance in MDI mode, the active MDI block is processed from the start.
- On starting after a Delete Residual Distance in Incremental Relative and Automatic modes, processing continues with the following block.

Automatic block advance

This command is described in Section 9.2.6.

Automatic block return

This command is described in Section 9.2.6.

Restart

You can use this command to reset the axis.

- Pulse output is interrupted.
- The instantaneous processing status is canceled, and synchronization in incremental encoders is deleted.
- Active compensation values are deleted.
- An acknowledge signal is issued for all errors.

Undo set actual value

You can use this command to reset coordinates modified with the functions “Set actual value” and “Set actual value on-the-fly” to their original value (if the axis is not in motion).

9.3.4 Zero offset (Write request in the user DB, DBX39.1)

Function of zero offset

A selection, change or cancellation of a zero offset takes effect with the next positioning action. With a zero offset, the instantaneous shift of the coordinate system is canceled, provided that a zero offset was already active and the specified shift change ($ZONPV_{new} - ZO_{old}$) was executed with the first positioning. All coordinates and software limit switches, the reference point and the actual value are updated accordingly.

The reference of the workpiece coordinate system is provided via the zero offset. The actual values read from the FM 353 refer to the machine coordinate system. The position specification in a traversing block is referred to the workpiece coordinate system.

Example of a zero offset:

Fig. 9-1 Zero offset

The zero offset can be deleted by:

- Transmitting shift value = 0
- Starting Reference-Point Approach mode
- Set reference point
- Eliminating axis synchronization (e.g. by a restart).

Rotary axis

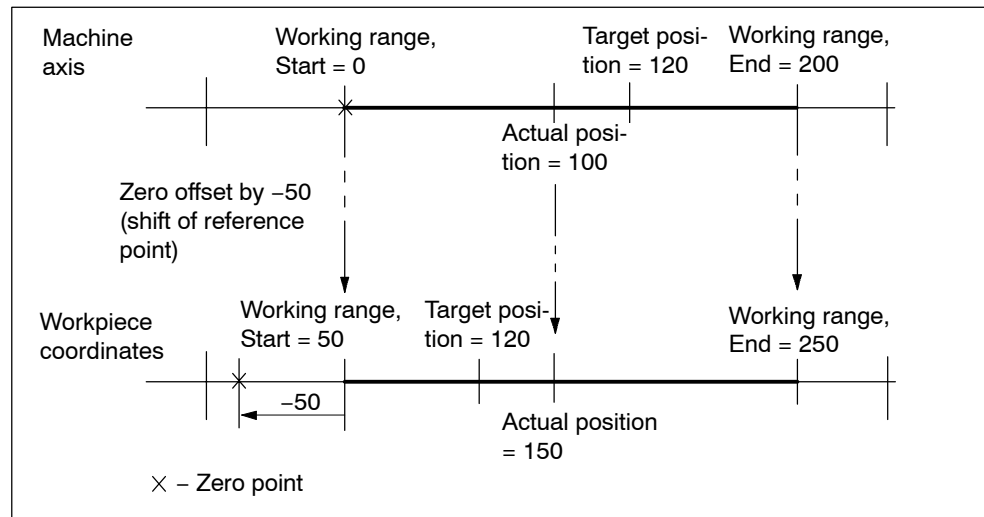
The following restriction applies to a rotary axis:

Zero offset < Rotary-axis range. The actual value is normalized.

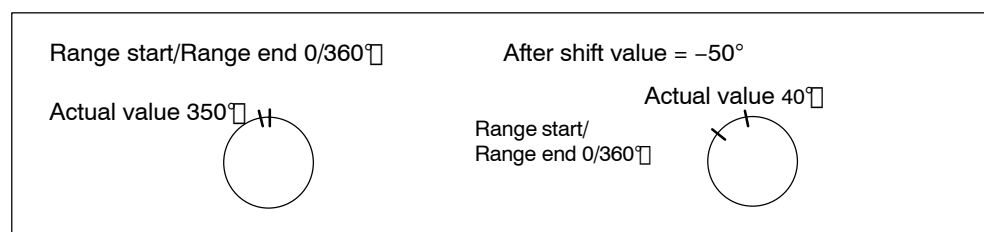
Example:

The start and end of the range are shifted -50° .

Exceptions:

In the Incremental Relative, MDI and Automatic modes, a zero offset is not possible until the block has been processed (position reached, programmed stop set), i.e. it is not possible when the axis is stationary after execution is interrupted with an abnormal stop.

9.3.5 Set actual value (Write request in the user DB, DBX38.7)

Overview

You can use this function to assign a new value to the current actual value.

Function of set actual value

By transmitting the coordinates, the actual value is set to this value when the axis is not in motion (after selecting "Processing in progress" = 0). The coordinates of the software limit switches remain unchanged.

Example of setting actual value:

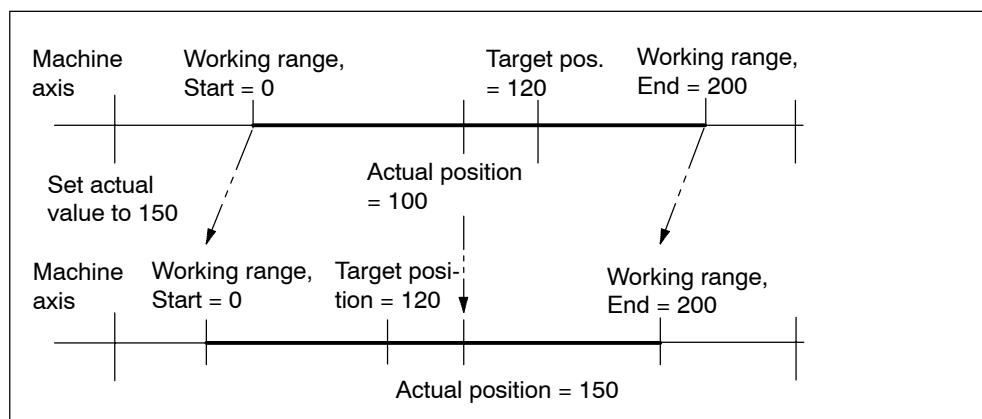

Fig. 9-2 Set actual value

The coordinates can be reset to their original value by:

- Including synchronization in Reference Point Approach mode
- Set reference point
- Remove setting actual value
- Restart

9.3.6 Set actual value on-the-fly (Write request in the user DB, DBX39.0)

Overview

You can use this function to assign a new value to the actual value by means of an external event.

Function of set actual value on-the-fly

By transmitting the coordinates (new actual value), set actual value on-the-fly is activated.

However, the Set Actual Value function is not triggered via the appropriate digital input until "Processing in progress" = 1.

Set actual value on-the-fly can be activated again by transmitting Set actual value on-the-fly again.

The coordinates can be reset to their original value by:

- Including synchronization in Reference Point Approach mode
- Set reference point
- Remove setting actual value
- Restart

Note:

For "set actual value on-the-fly" in "Automatic" mode, see Section 9.2.6

9.3.7 Request application data (Write request in the user DB, DBX39.6)

Overview

A selection of up to four display data items whose values can be read out with “read application data” (see Section 9.3.13).

Code table:

Code	Significance
0	No parameter request
1	Actual position
2	Actual speed
3	Residual distance
4	Set position
5	Total current coordinate shift
6	Rotational speed
16	Frequency output value
17	Pulse output counter ($0 \dots 2^{16} - 1$) [pulse]
20	Difference between target and actual position [MSR]
22	Switch adjustment in “Reference point approach” mode

The code should be entered in CODE_AP1 – AP4.

These values are always updated in the FM cycle.

The selection is stored on the FM, i.e. you need make the selection only once to read the corresponding values cyclically afterwards (user DB, DBX43.6).

9.3.8 Teach in (Write request in the user DB, DBX39.7)

Overview

In a program block selected with the program number and block number, the current actual position is entered as a position setpoint (**Caution:** This is an absolute position).

The Teach-in facility is possible only in the following modes:

- Jogging
- Incremental Relative
- MDI

and while the axis is not in motion.

The program and the appropriate program block must be present on the FM 353 (see Parameterization, Chapter 5).

9.3.9 Set reference point (Write request in the user DB, DBX38.6)

Overview

You can use this function to synchronize the axis without reference point approach.

Function

With Set Reference Point, a position value at the instantaneous position of the axis, indicated as a parameter, is accepted as an actual value.

"Set reference point" is not possible during machining ([BL] = 1) and will only come into effect after machining ([BL] = 0).

This function is not effective in "Automatic" mode (mode 08) or in "Automatic Single block" mode (mode 09).

9.3.10 Measured values

Prerequisites

The following prerequisites must be fulfilled to execute the “Measuring” function:

1. Connect a bounce-free switching-signal encoder (sensing probe) to a digital output of the FM 353.
2. Parameterize “Measurement” for this input in MD34.

Activating the measuring function

The “Individual settings” function (AW-DB, DBB34 and 35) can be used to activate a “length measurement” or “in-process measuring”.

Because both functions use the same digital input of the FM 353, only one function can be performed at a time. If both functions are activated at the same time, both functions are deactivated, and an error message is output.

Function description

Measurement functions can be executed in all modes. An executed measurement is signaled by the checkback signal “ME” and optionally also by a process interrupt.

Inprocess measurement

The present actual position is captured at each rising edge of the touch probe. At the same time, the axis movement is interrupted (servo-controlled braking).

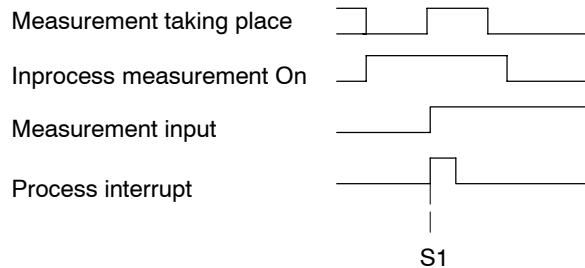

S1 – execution of measurement

Length measurement

The current actual position value is acquired at both the rising and the subsequent falling edge of the sensing probe. In addition, the distance (absolute value) actually traversed between the two edges is determined.

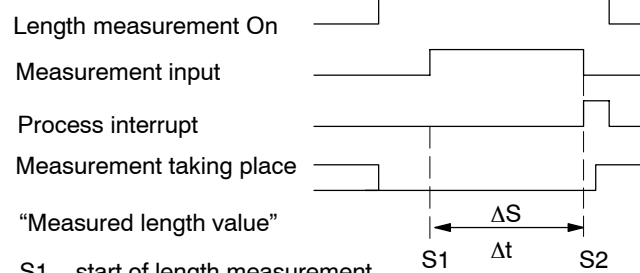

S1 – start of length measurement

S2 – end of length measurement

ΔS – Measured length value

Δt – minimum signal length at the digital input: $\geq 2 \cdot \text{FM cycle}$

The measured length is determined as follows under certain supplementary conditions:

- **Retrigger the reference point:**
The measured length constitutes the difference of the edge positions.
- **Set the actual value:** The measured length constitutes the distance actually traversed.
- **Zero offset:**
The “Zero offset” function does not change the actual position of the axis and is thus not relevant for evaluations regarding the “Length measurement” function.
- **Rotary axis:**
The measured length is the path actually traversed over several rotations of the rotary axis.
- **Direction reversal:**
The axis can change the traversing direction within the length to be measured as often as you want.
 - **Case 1:**
The axis passes the falling edge in the traversing direction of the rising edge: The measured length is the difference of the edge positions.
 - **Case 2:**
The axis passes the falling edge in the opposite direction to the rising edge: End of the length measurement with output of an error message.

Error messages

The following table lists the errors that can occur in the execution of the Measurement function.

Error	Significance
Travel errors	The "Digital input not parameterized" error is signaled when a measurement function is selected without a digital input having been parameterized (see Troubleshooting, Table 11-7, Class 3 No. 30).
Operator contr. errors	The "Measurement function undefined" error is signaled when both measuring functions are selected (see Troubleshooting, Table 11-6, Class 2 No. 16).
Measuring error	An erroneous length measurement is indicated by signaling back the length "-1." Possible causes include: <ul style="list-style-type: none"> • Resynchronization in the Reference-Point Approach mode while a measurement is in progress • Execution of the Set Reference Point function while a measurement is in progress • Direction of travel at the falling edge is opposite to the direction of travel of the previous rising edge

Measurement-value checkback signals

The checkback signal ME (see Section 9.1) signals the status of function execution, as follows:

"ME"	Inprocess measurement	Length measurement
0	<ul style="list-style-type: none"> • the Length Measurement and Inprocess Measurement functions are inactive • with Start after a prior measurement 	<ul style="list-style-type: none"> • the Length Measurement and Inprocess Measurement functions are inactive • with front edge of the touch probe signal after a prior measurement
1	With the front edge of the touch probe signal (= Inprocess Measurem. is in progr.)	With the back edge of the touch probe signal (= Length Measurement is in progress)

Reading out the measured values

After performing the "Length measurement" and "In-process measurement" functions you can read out the measured values from the FM 353 by calling the **POS_MSRR** block using the AW-DB read job, **DBB43.7** (see Section 6.3.5).

The measured values read out are valid for the performed measuring process starting from the "ME" checkback signal until the edge of the subsequent measuring job arrives.

No.	Value 0	Value “-1”	All other positive values	All other negative values
1	the Length Measurement and Inprocess Measurement functions are inactive	Actual position for rising touch-probe edge in Inprocess Measurement and Length Measurement functions		
2	<ul style="list-style-type: none"> the Length Measurement and Inprocess Measurement functions are inactive always with the Inprocess Measurement function 	Actual position for falling touch-probe edge in Length Measurement function		
3	<ul style="list-style-type: none"> the Length Measurement and Inprocess Measurement functions are inactive always with the Inprocess Measurement function measured length 0 is actually possible, because touch probe has been connected while axis is stationary 	Erroneous length measurement	Measured length	Nonexistent

9.3.11 Basic operating data (Read request in the user DB, DBX42.0)

Overview

The following display data are basic operating data:

- Actual position [MSR]
- Actual speed [MSR/min]
- Distance-to-go [MSR]
- Set position [MSR]
- Total of active coordinate shifts for tool offset, zero offset [MSR]
- Rotational speed (rotary axis only) [rpm]

9.3.12 Active NC block (Read request in the user DB, DBX42.1), next NC block (Read request in the user DB, DBX42.2)

Active NC block

... are display data in "Automatic" mode

/	Skipped block
L	Subprogram callup (fills in UP number)
P	Number of runs for subprogram (fills in UP number of runs)
X/t	Position/dwell time programmed (fills in value 1)
G1-G3	G function group 1-3
D	Tool offset value number
M1-M3	M function group 1-3
F	Speed programmed (fills in value 2)

Byte	Data format	Bit							
		7	6	5	4	3	2	1	0
0	Byte	NC program number							
1	Byte	NC block number							
2	8-bit	/	L	P	X/t	0	G3	G2	G1
3	8-bit	0	0	0	D	M3	M2	M1	F
4	Byte	G function 1							
5	Byte	G function 2							
6	Byte	G function 3							
7	Byte	0							
8	DINT	32-bit value 1 (UP number, bytes)							
12	DINT	32-bit value 2 (UP number of runs, bytes)							
16	Byte	M function 1							
17	Byte	M function 2							
18	Byte	M function 2							
19	Byte	D function							

Next NC block

as described in "active NC block"

9.3.13 Application data (Read request in the user DB, DBX43.6)

Overview

The values requested with “Request application data” (user DB, DBX42.3, see Section 9.3.7) are returned by the FM 353 when the user submits the Read request (user DB, DBX43.6).

9.3.14 Actual value block change (Read request in the user DB, DBX42.3)

Overview

The “actual value block change” function is described in Section 10.1, G50, G88, G89.

9.3.15 Servicing data (Read request in the user DB, DBX42.4)

Overview

The following display data of the measuring circuit are servicing data:

- Frequency output value [Hz]
- Pulse output counter ($0 \dots 2^{16} - 1$) [pulse]
- Difference between target and actual position [MSR]
- Switch alignment in BA “Reference point approach” [MSR]

9.3.16 Additional operating data (Read request in the user DB, DBX43.5)

Overview

The following display data are additional operating data:

- Override [%]
- NC traversing program No.
- NC block No.
- UP callup counter
- G90/91 active, see Section 10.1
- G60/64 active, see Section 10.1
- G43/44 active, see Section 10.1
- D No. active, see Section 10.1
- Status messages 1 (data type: BOOL):
Velocity limitation to maximum frequency MD41
- Status messages 2 (data type: BOOL):
When the acceleration or time override is programmed, a displayed limitation of the active limitation occurs in the event that the working range of the frequency generator of the FM 353 is violated (compare the diagram “Working range, frequency generator” Figure 5-5):
 - Start/Stop frequency is limited (MD39)
 - Frequency value for acceleration switchover limited (MD40)
 - Acceleration/delay value is limited (MD42 – MD45)

9.3.17 Parameters/data (Read request in the user DB, DBX43.3)

Overview

This request is used to read the parameters and data modified by means of the “Change parameters/data” function (Write request in the user DB, DBX39.3, see Section 9.3.1).

9.4 System of measurement

Overview

At the start of parameterization, you must fill in the basic machine data item **system of measurement** (MD7). This item governs the input of values.

Variants of the system of measurement

You can set the system of measurement for the following three units:

- mm
- inches
- degrees

Input of machine data

All value inputs and all value ranges refer to the setting in the system of measurement.

Internal processing of values

In “Parameterize FM 353” and in the FM 353 itself, values are processed in the following base units:

- 0.001 mm
- 0.0001 inch
- 0.0001 degree

Examples

The sample values in the table below illustrate the relation between the system of measurement and internal values:

System of measurement	Internal values	Input at interface	
mm	10^{-3} mm	$10\,995 \cdot 10^{-3}$ mm	10.995 mm
inches	10^{-4} in(ch)	$10\,995 \cdot 10^{-4}$ in(ch)	1.0995 in(ch)
degrees	10^{-4} degree 10^{-2} degree	$3,600,000 \cdot 10^{-4}$ degree $36,000 \cdot 10^{-2}$ degree	360.0000 degree 360.00 degree

Note

The measurement system (MD7) must match the measurement system specified in the other DBs.

The measurement system raster (MSR) is the smallest distance unit in the active system of measurement.

If at some point you have failed to take this precaution:

1. Delete all data blocks (which do not match the measurement system) or clear the memory of the FM 353 completely.
 2. Modify the other data blocks on the PG.
 3. Reload the data blocks to the FM 353.
-

9.5 Axis type

Overview

You can select the axis type with machine data item MD8. Choose either of the following types:

- Linear axis
- Rotary axis

Linear axis

A linear axis moves between two range limits (traversing range min -10^9 , max 10^9). The range limits may be bounded by software limit switches (MD21, MD22) to form the “working range.”

Linear axes have a limited traversing range. The limits are imposed by the:

- Resolution of the numerical scale
- The range covered by an absolute encoder.

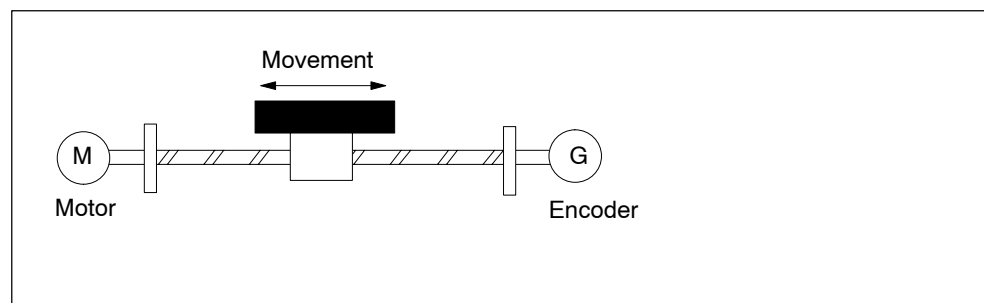

Fig. 9-3 Linear axis

Rotary axis

With rotary axes, the actual value is reset to “0” after one revolution. Rotary axes thus have an infinite traversing range.

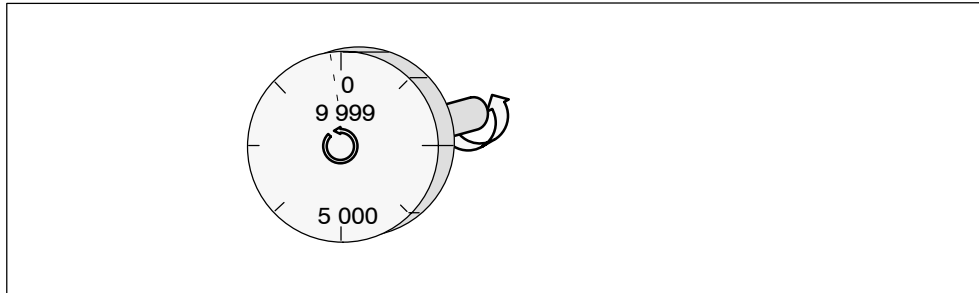

Fig. 9-4 Rotary axis

Before you start a movement in “MDI” and “Automatic” modes, you can define a fixed direction of rotation with R+ or R-.

Rotary axis end

Machine data item MD9 defines the value by which the FM 353 recognizes the end of the rotary axis.

This value is the theoretical maximum that the actual value can reach. At this value, display of the actual value switches back to 0.

The theoretical maximum, however, is never displayed, because it is physically located in the same position as the start of the rotary axis (i.e. 0).

Example:

The following example in Figure 9-4 illustrates the behavior of the axis.

Assume you specify a value of 10,000 for the end of the rotary axis.

The value 10,000 will never be displayed. The display always rolls over from 9,999 to 0.

If the direction of rotation is negative, the display rolls over from 0 to 9,999.

Rotary axes are subject to certain restrictions in the choice of gear ratio, as shown in Figure 9-5. These restrictions arise from the need to reproduce the actual position accurately over several revolutions when referencing with one periodic zero pulse per motor revolution (type of reference point approach < 4). See also “Dependencies”, Section 5.3.1).

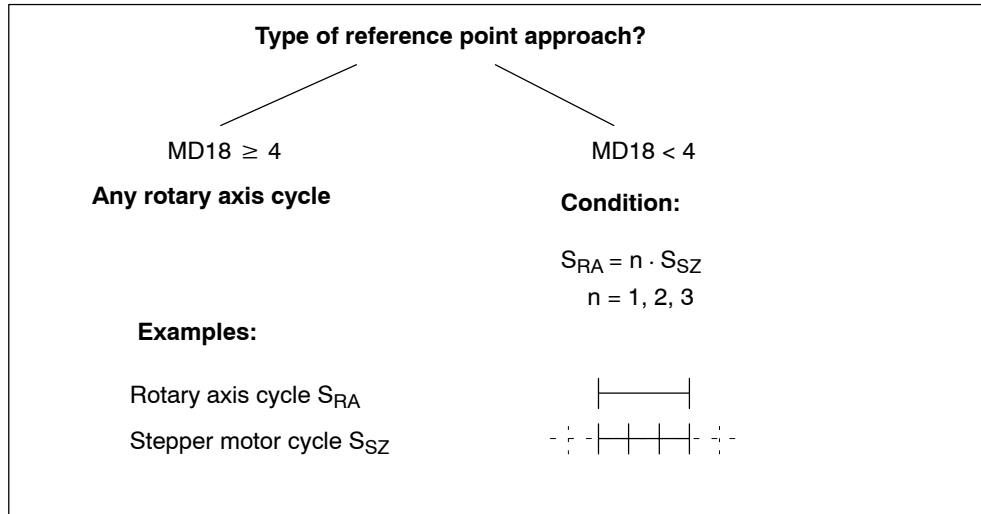

Fig. 9-5 Restriction for rotary axis cycle

9.6 Determining the position

Overview

The FM 353 operates without encoders.

The position resolution of the axis is determined by the traversing distance of one motor increment.

The control frequency pulses emitted by the FM 353 are added internally to form a position value.

Function parameters

The following table shows you how to adapt a stepper motor to the FM 353.

MD	Designation	Value/Meaning	Comments/Unit
11	Distance/motor revolution (division period)	1...1 000 000 000 1)	[MSR] (integer component)
12	Residual distance/motor revolution (division period)	0...2 ³² -1 1)	[2 ⁻³² MSR] (fractional component)
13	Increments/motor revolution (division period)	2 ¹ ...2 ²⁵ 1)	Entry per stepper motor data plate

1) see Section 5.3.1, Dependencies

MSR stands for measurement system raster (see Section 5.3.1)

9.6.1 Synchronizing the stepper motor axis

Overview

When stepper motors are used, there is an unknown offset between the internal position value and the mechanical position of the axis after the FM is switched on. To establish the position reference, the value internal to the FM must be synchronized with the real position value of the axis. Synchronization is performed by taking over a position value at a known point of the axis.

Reference point approach

is an operating mode used to position the axis at the reference point.

Reference point

is a fixed point on the axis. It is:

- The target coordinate in the Reference-Point Approach mode
- Removed from the synchronization point by the amount of the reference-point shift, in axes with incremental encoders.

Reference point offset

Difference in distance between the synchronization point and the reference point.

The reference-point shift serves:

- for numeric adjustment of stepper motor.
- as a displacement reserve to brake the drive if the synchronization point is overshoot.

Reference point switch (RPS)

The reference point switch selects the synchronizing zero marker on the traversing path of the axis.

- It is also the signal encoder for a speed reduction before the synchronization point is reached.
- It is connected to a digital input of the FM 353.

Synchronization point

is a defined point on the traversing path of the axis. It is defined by the mechanical position of a reference-point switch or in association with a cyclic zero mark of an incremental encoder.

Synchronization

Creating the position reference between the internal FM position value and mechanical position of the axis.

Measured value synchronization

Irrespective of the approach direction, the synchronization point can be located on the side of the lower or the higher actual position values in relation to the reference point switch position. It is demarcated by the rising edge of a zero pulse or by the reference point switch. This selection is made by the MD18 (together with the approach direction).

Example

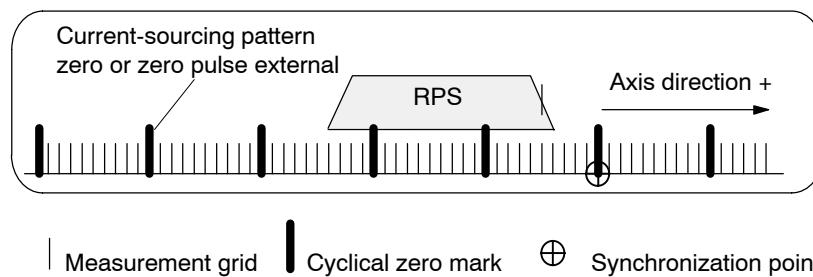

With reference to the synchronization point, the reference point can be located on the side of the lower or the higher position actual values. In the “reference point approach” operating mode the machine axis additionally traverses this distance, during its last phase of motion, once the synchronization point has been found. Consequently, the axis halts the motion, in each instance, exactly on the reference point.

Example

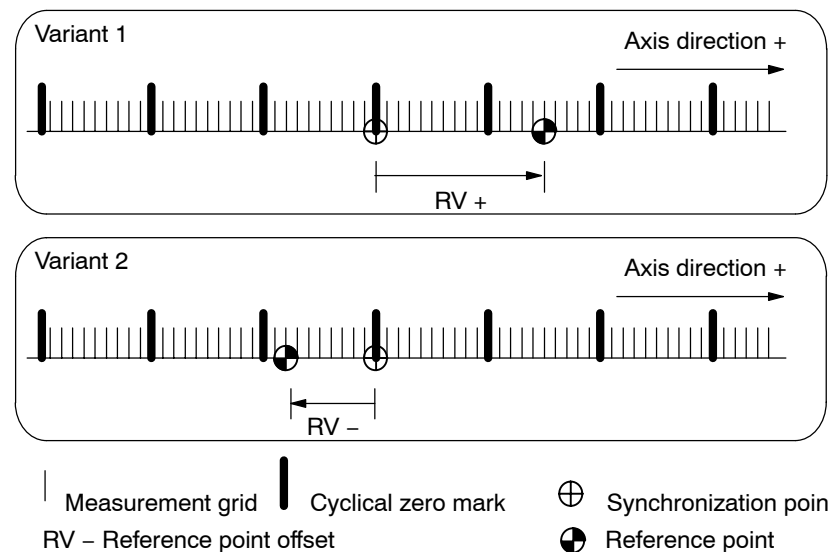

9.7 Stepper motor control system

Overview

Actuation of the stepper drive for controlling the movement sequence takes place by way of the signals "Pulse" (frequency) and "Direction". These signals are generated by a frequency generator in each operating mode of the FM 353. The pulse width is a constant 50% of the period of the maximum frequency parameterized.

The diagram 9-6 gives you an overview of the function units and the machine data acting upon them.

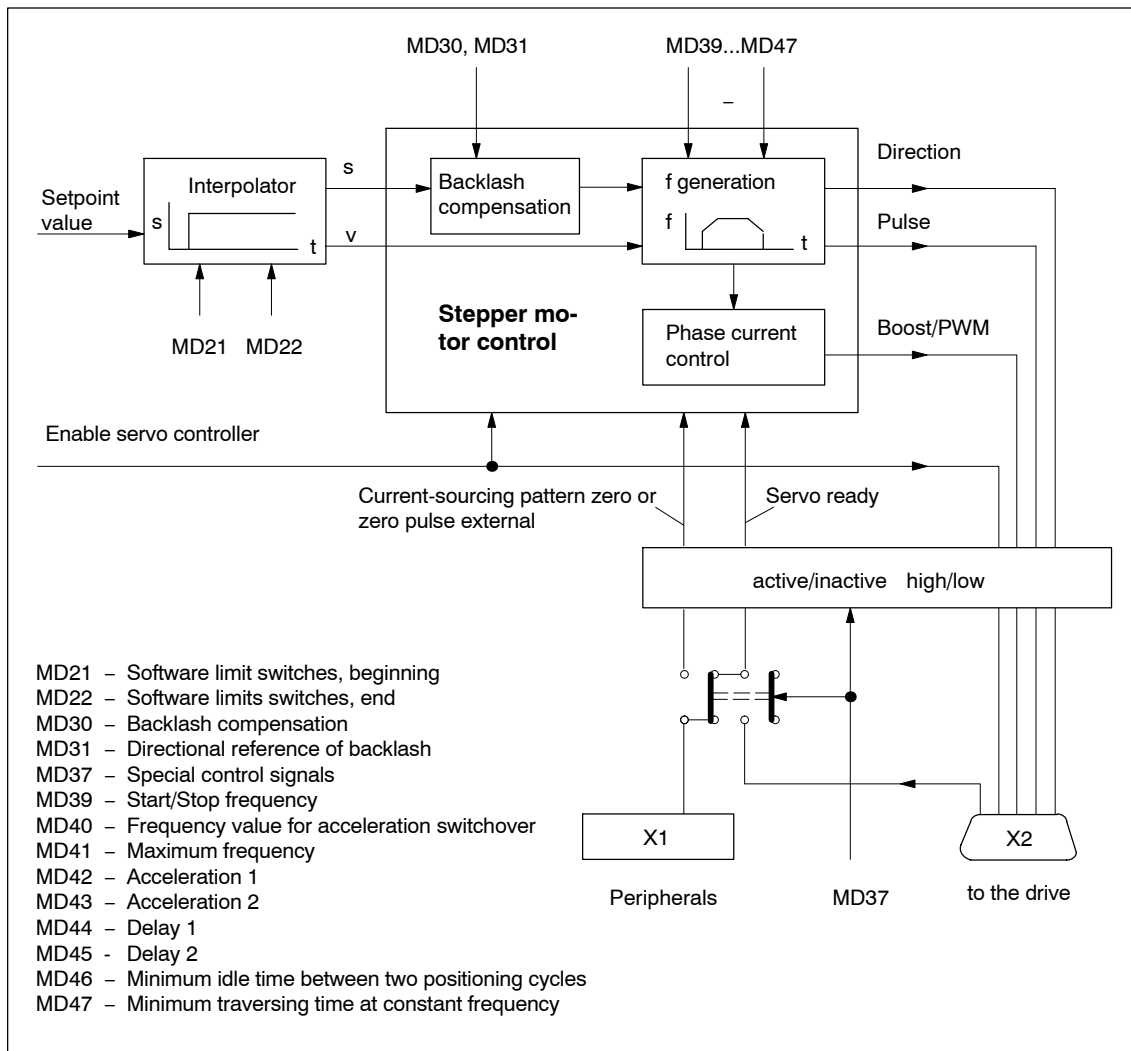

Fig. 9-6 Overview of stepper motor control system

Software limit switches

Software limit switches MD21 and MD22 are used to limit the working area (see Section 9.9). The value of MD21 must be less than the value of MD22 at all times.

MD	Designation	Value/Meaning	Unit
21	Software limit switch, beginning	-1 000 000 000...<+ 1 000 000 000 ¹⁾	[MSR]
22	Software limit switch, end		

1) see Section 5.3.1, Dependencies

MSR stands for measurement system raster (see Section 5.3.1)

Backlash compensation

Mechanical drive elements generally have a certain amount of backlash (play).

MD30 provides compensation of mechanical reversal backlash. With each reversal of direction, the mechanical backlash runs through before any axis movement takes place. This results in positioning errors.

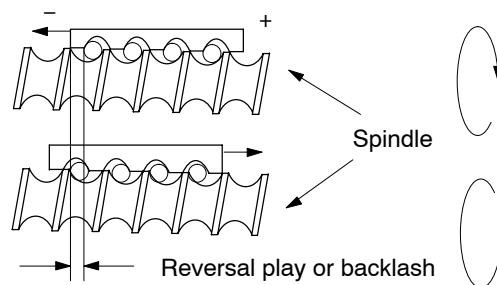

A backlash figure entered in the MD30 is calculated, with correction, by the stepper motor control as a factor of the current traversing direction of the axis. The result is an approximate compensation of backlash during positioning.

In MD31, the “backlash-free” traversing direction of the axis is identified. When MD31 = 0, that direction is considered to be “backlash-free” which corresponds to the direction of the axis movement at the time synchronization is begun. This corresponds to the following correspondence, as a factor of MD18:

MD18 = 0,2,4,8: Plus direction is backlash-free

MD18 = 1, 3, 5, 9: minus-direction backlash-free

MD	Designation	Value/Meaning	Unit
30	Backlash compensation	0 to 10,000	[MSR]
31	Directional reference backlash	0 = as with reference point approach	-

The backlash is traversed at a speed of 1% of the maximum possible speed (MD23).

Other function options

The particulars of backlash compensation can be defined with MD52 and MD53.

MD	Function	Value/Description	Unit
52	Speed for backlash compensation	0 Backlash traversing speed 1 % of MD23 1 to 1 00 Backlash traversing speed in % of MD23	[%]
53	Mode for backlash compensation	0= Backlash compensation prior to positioning 1= Backlash compensation during positioning The backlash traversing speed is added to the programmed speed for the traversing job affected by override.	–

Note the following carefully:

- If the interdependencies of the MDs are violated, an error is reported with “range violation” as its cause.
- Backlash compensation goes into effect prior to reference point approach.
- A change in MD30 (backlash) takes effect only after a traversing movement in a backlash-free direction (MD31).
- Backlash travel is started only if override ≥ 0 .

9.7.1 Frequency generation

Function parameters

The following table shows you which parameters to use in matching frequency generation to the selected stepper drive.

MD	Designation	Value/Meaning	Unit
39	Start/Stop frequency (f_{ss})	10 – 10,000	[Hz]
40	Frequency value for acceleration switchover (f_{eg}) ¹⁾	500 – 75,000 Minimum value: MD39 Maximum value: MD41	[Hz]
41	Maximum frequency (f_{max})	500 – 200,000	[Hz]
42	Acceleration 1 (a_{b1}) ¹⁾	10 – 10,000,000	[Hz/sec]
43	Acceleration 2 (a_{b2}) ¹⁾	10 – MD42, 0 as with MD42	[Hz/sec]
44	Deceleration 1 (a_{v1}) ¹⁾	10 – 10,000,000, 0 = as with MD42	[Hz/sec]
45	Deceleration 2 (a_{v2}) ¹⁾	10 – MD44, 0 = as with MD43	[Hz/sec]
46	Minimum idle time between two positioning cycles (t_{st})	1 – 10,000	[ms]
47	Minimum traversing time at constant frequency (t_{vk})	1 – 10,000	[ms]

1) see Section 5.3.1, Dependencies

Frequency profile

In controlling speed, special importance is attached to the drive-specific requirements regarding the shape of the frequency/time function. Based on this, a discontinuous traversing movement is initiated or stopped below the Start/Stop frequency. For higher traversing velocities, a ramp-shaped control cycle, which builds on the Start/Stop frequency, takes place within two velocity ranges with acceleration values of different parameterization capability .

The following illustrations provide you with examples of frequency profiles for selected traversing movements.

Maximum speed frequency profile

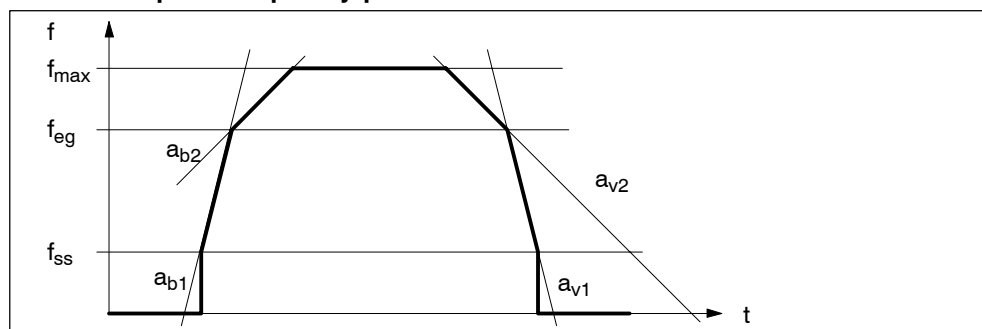

Fig. 9-7 Maximum speed frequency profile

Frequency profile with G64 or speed override

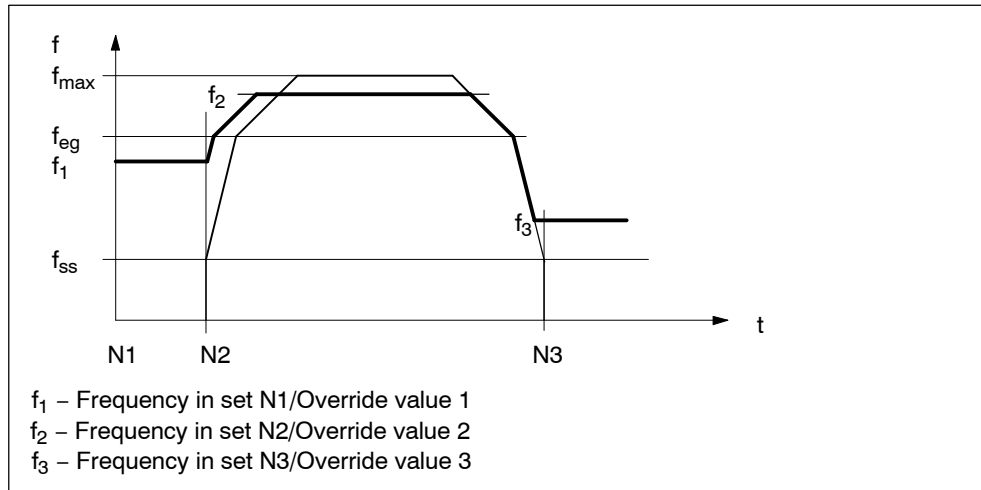

Fig. 9-8 Frequency profile with G64 or speed override

Frequency profile with Stop or G60

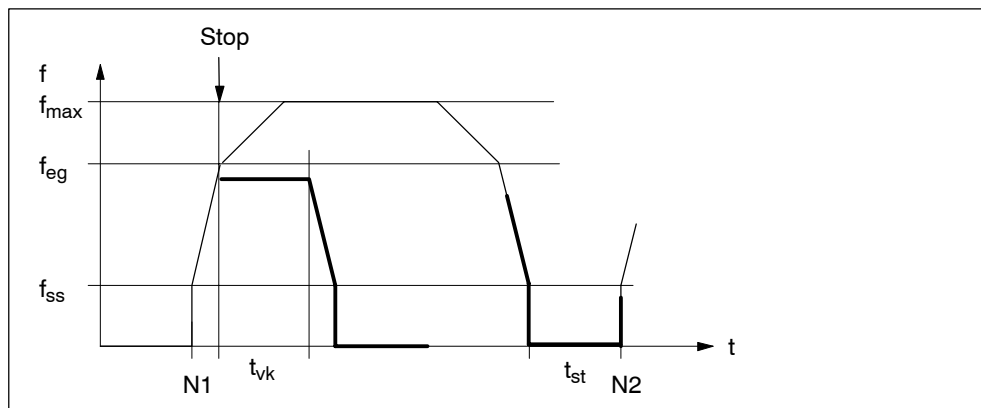

Fig. 9-9 Frequency profile for Stop or G60

9.7.2 Drive interface

Overview

As a minimum, actuation of the stepper drive for controlling the movement sequence takes place by way of the signals “Pulse” and “Direction”. By way of these signals for specifying distance beyond the stepper drive, the FM 353 optionally processes additional signals from different drive ports.

Standard signals “pulse”, “direction”

Through the FM 353, pulse length is automatically set to $T = 0.5 \cdot MD41$.

Direction of rotation for the stepper drive is controlled with the direction signal.

The level of both signals can be parameterized.

MD	Designation	Value/Meaning	
37	Special control signals		
37.8	Pulse output inverted	0: Pulse high active 1: Pulse low active	Output signal
37.9	Direction output inverted	0: low sign. = direction + 1: low sign. = direction -	Output signal

Optional signals “servo enable”, “servo ready”

These signals are used to activate the drive. The “Servo ready” signal can be connected to the FM 353 either via the X2 connector at TTL level, or X1, with the 24 V level (see Section 4).

The active level for both signals can be parameterized.

MD	Designation	Value/Meaning	
37	Special control signals		
37.0	Controller enable active	0: Signal not used 1: Signal used	Output signal
37.2	Controller ready active	0: Signal not connected 1: Signal is connected	Input signal
37.3	Controller ready inverted	0: Controller ready high active 1: Controller ready low active	
37.4	Controller ready input selection	0: at Front panel connector X1 (RM) 1: at D Sub connector X2 (Ready1_N)	

In all operating modes except Control mode, the “servo enable” signal is required for the duration of every traversing movement, irrespective of the parameter definitions. If the servo enable is not detected or is deactivated during the movement, the “servo enable missing” message is triggered (see Table 11-5, Class 3/No. 61).

In all operating modes except Control mode, the “servo ready” signal is required for the duration of every traversing movement when the parameter is active (MD37.2). If the servo ready is not detected or is deactivated during the movement, the “servo not ready” message is triggered (see Table 11-5, Class 3/No. 62).

Optional signal “Boost” / “PWM”

The interface signal “Boost” or “PWM” (pulse width modulation) permits optimized operation of the stepper drive using phase current control. The FM 353 implements these two functions via an output. This is done by alternate machine data selection.

The active level of the signal can be parameterized.

Signal response:

Movement status	Output signal “Boost”	Output signal “PWM”
Idle	inactive	pulse duty factor per MD 51
Acceleration/delay	active	static active
Constant travel	inactive	pulse duty factor per MD 50

The following table shows you the available machine data for parameterizing the function.

MD	Designation	Value/Meaning	
37	Special control signals		
37.16	Boost active	0: Boost function not used 1: Boost function used	Output signal
37.17	Boost inverted	0: Boost signal high active 1: Boost signal low active	
37.18	PWM active	0: PWM function not used 1: PWM function used	
37.19	PWM inverted	0: PWM pulse high active 1: PWM pulse low active	
48	Boost duration absolute	1 – 1,000,000 ms	
49	Boost duration relative	1 – 100%	
50	Phase current travel	Pulse duty factor [%]	
51	Phase current idle		

Function, PWM:

The signal is generated as a 20 kHz frequency.

Boost function:

The signal is monitored with reference to the maximum absolute and relative active phase.

Effect: PWM

The motor phase current can be changed between 0 % and 100 %. Current modification is possible at zero speed and during continuous travel. On acceleration/deceleration, the current is always 100 % (max).

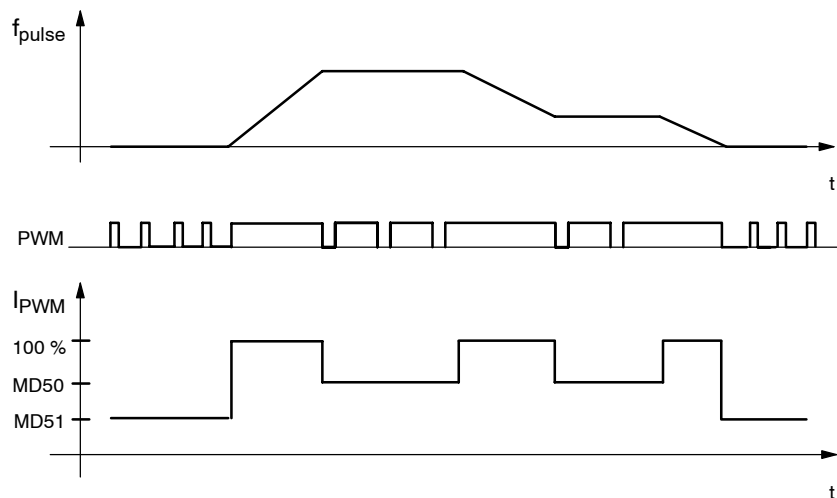
**Effect: Boost**

During acceleration/deceleration, the activated boost signal triggers a current increase on the drive unit. The amount of the increase is set on the drive unit. At zero speed and during continuous travel, the current is always 100 %.

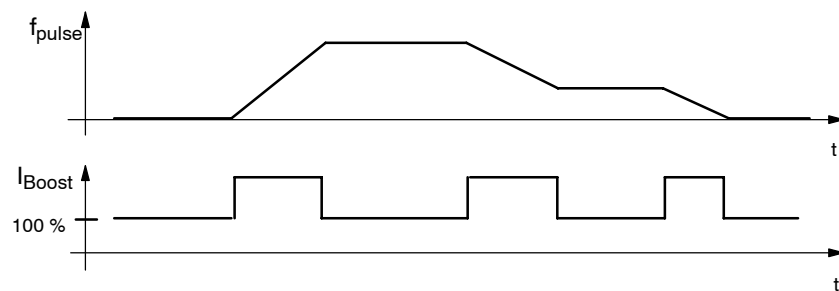
**Optional signal “Current-sourcing zero” or “Zero pulse external”**

To support stepper motor axis synchronization, the FM 353 processes a cyclic input signal (which is dependent on the axis movement) as a zero marker (see Section 4.4). This signal can be either the “Current-sourcing pattern zero” signal from the stepper drive, or a “Zero pulse external” signal (e.g. initiator) generated once per stepper motor revolution. The active level of the signal can be parameterized.

Note

When using this signal, the signal “Controller ready” can be processed only by way of the **D Sub connector X2 (Signal Ready1_N)**!

The following cases must be distinguished:

Technical implementation	Signal shape	Parameter definition
Signal encoder on the motor axis (e.g. initiator)	Active phase over several motor increments, one time per revolution	“Zero pulse external”
Cyclical signal generated by the stepper drive one time per motor revolution (e.g. zero trace of a motor-integrated incremental encoder)	Active phase over one motor increment, one time per revolution	“Current-sourcing pattern external” and MD38=0
Cyclical one-time signal in current-sourcing pattern from stepper drive	Active phase in current-sourcing pattern zero of the stepper drive, n-times per revolution (n = current-sourcing pattern number)	“Current-sourcing pattern external” and MD38= MD13/n

The following table shows you the available machine data for parameterizing the function.

MD	Designation	Value/Meaning	
37	Special control signals		
37.24	Current-sourcing pattern zero active	0: Current-sourcing pattern zero not used 1: Current-sourcing pattern zero used	Input signal
37.25	Current-sourcing pattern zero inverted	0: Current-sourcing pattern zero high active 1: Current-sourcing pattern zero low active	
37.26	Zero pulse external active	0: Zero pulse external not used 1: Zero pulse external used	
37.27	Zero pulse external inverted	0: Zero pulse external high active 1: Zero pulse external low active	
38	No. of increments/current-sourcing pattern cycle ²⁾	0...400 ¹⁾	

- 1) Compare documentation from stepper drive manufacturer.
- 2) See Section 5.3.1, Dependencies

9.7.3 Rotation monitoring

Prerequisites

The following prerequisites must be met for the “Rotation monitoring” function:

1. External zero pulse (NIX) which is generated cyclically, precisely once per motor revolution

Condition:

At the maximum speed of the stepper motor, a signal length of $\Delta t \geq 2 \cdot FM$ cycle must be assured for the external zero pulse!

2. Connection to the “Servo message” input of the FM 353’s front panel connector.
3. Parameterization of the external zero pulse (MD37.26)
4. Use of the current-sourcing pattern zero signal is not allowed!

Activation of rotation monitoring

For “rotation monitoring” single function, see Section 9.3.2.

Error message

The following errors are reported:

- Error “Digital input not parameterized” (see Troubleshooting, Table 11-5, Kl. 3/Nr. 30)
Selecting function without parameterization for NIX
- “Rotation monitoring” error (see Troubleshooting, Table 11-5, Cl. 3/No. 66)
 - Motor turns too slowly (during acceleration/travel)
 - Motor turns too fast (during acceleration/travel)
 - External zero pulse failed
 - Incorrect number of increments per motor revolution parameterized (MD13)

Function description

The external zero pulse is used as described below to monitor the motor rotation as specified in controlled operation (see Figure 9-10)

- The first NIX received synchronizes rotation monitoring.
- The first NIX must arrive within the period elapsing during two stepper motor rotations $+ 45^\circ$. Otherwise, the "Rotation monitoring" error message will be triggered.
- With every further NIX received, the system verifies whether the current pulse output of the stepper motor is within a window $n \cdot 360^\circ \pm 45^\circ$. The error "Rotation monitoring" is triggered by the occurrence of NIX edges which are outside the allowed window.
- With every FM cycle the system verifies whether the pulse output is outside a window $\pm (360^\circ + 45^\circ)$ since receipt of the last NIX. Positioning outside this allowable window also triggers the "Rotation monitoring" error.
- Stepper motor rotation without a specified setpoint value likewise triggers a "Rotation monitoring" error in response to the NIX edges caused by the unwanted rotation. This occurs whenever the previous setpoint position falls within the range outside the allowable window for the NIX edges. No error is triggered if the previous setpoint position is within the admissible window as there is no way of distinguishing between oscillation on a NIX edge position on account of a fault or full motor rotation.
- Rotation monitoring is automatically discontinued whenever the synchronization mark is passed over in the "Reference point approach" operating mode, and the function "Retrigger reference point approach" is executed.

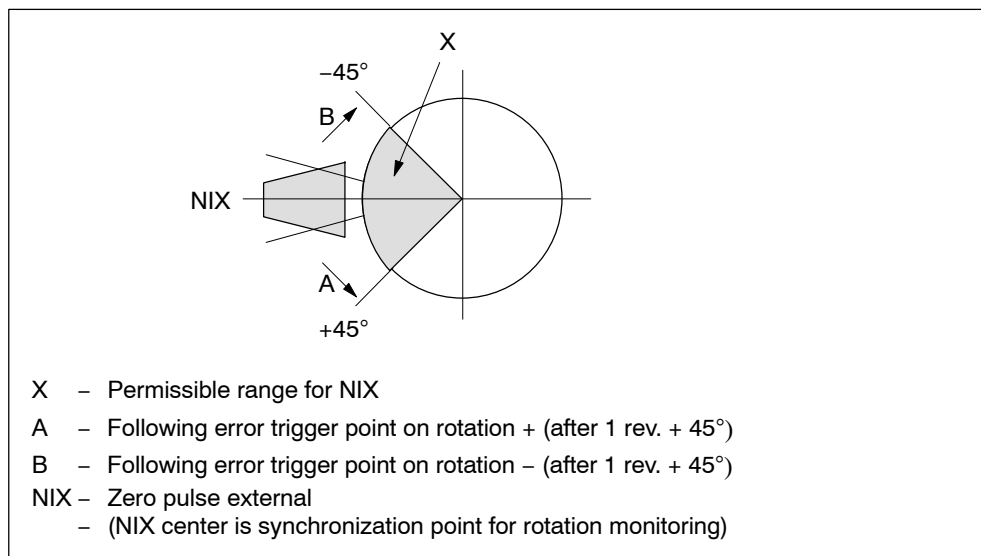

Fig. 9-10 Allowable range relative position for the external pulse

9.8 Digital inputs/outputs (Read request user DB, DBX43.4)

Overview

Four digital inputs and four digital outputs of the FM 353 can be used specifically to a given application.

The conventions and parameterization for this purpose are defined in the machine data MD34 to MD36.

The signals are processed in the FM cycle.

The signal status of the digital inputs and outputs can be recognized by readback (user DB, DBX43.4).

Function parameters

Table 9-9 shows you the functions assigned to each input/output.

Table 9-9 Function parameters for digital I/Os

MD	Designation	Data type, bit array/meaning			
34	Digital inputs ¹⁾	I0	I1	I2	I3
		0	8	16	24 = External start ²⁾
		1	9	17	25 = Enable input
		2	10	18	26 = External block change
		3	11	19	27 = Set actual value on-the-fly
		4	12	20	28 = Measurement (inprocess measurement, length measurement ²⁾)
		5	13	21	29 = Reference point switch for reference point approach ²⁾
		6	14	22	30 = Reversing switch for reference point approach ²⁾
35	Digital outputs ¹⁾	Q0	Q1	Q2	Q3
		0	8	16	24 = Position reached, stop
		1	9	17	25 = Axis movement forwards
		2	10	18	26 = Axis movement backwards
		3	11	19	27 = Change M97
		4	12	20	28 = Change M98
		5	13	21	29 = Start enable
		7	15	23	31 = Direct output

1) see Section 5.3.1, Dependencies

2) Signal length $\geq 2 \cdot$ FM cycle

Level adjustment

MD	Designation	Value/Meaning	Comments
36	Input adjustment	8 = I0 inverted 9 = I1 inverted 10 = I2 inverted 11 = I3 inverted	Front edge always activates the function

9.8.1 Function description for digital inputs

External start

The control signals of the axis include the start signal which triggers a positioning operation in “Reference point approach”, “MDI” and “Automatic” modes. A logical OR is established with the “External Start” digital input and the control signal (ST).

External start is connected to digital input I1.

Example

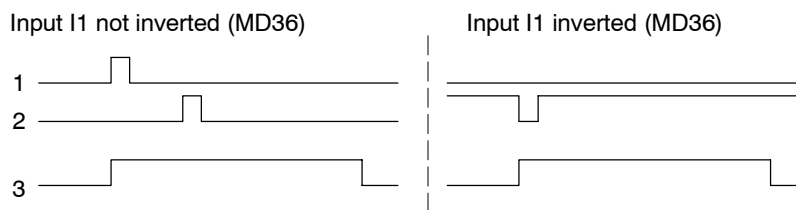
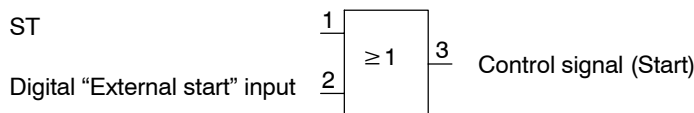

Minimum signal length at the digital input: $\geq 2 \cdot \text{FM cycle}$

Enable input

Setting the enable input is a prerequisite for positioning, movement or output of an axis, if this is parameterized with MD34. A reset stops the movement (external movement enable).

- In the Jogging and Control modes, the movement of the axis proceeds as long as the AND link continues between the control signal (R+/R-) and the enable input.

Example

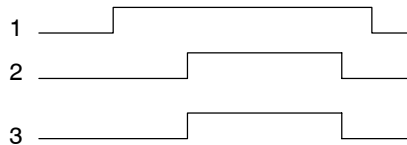
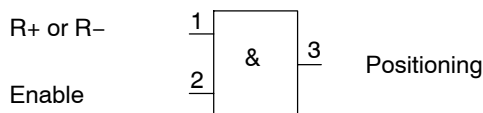

- In the other modes, note the following:

If the enable input is not yet set after a Start edge, this Start edge is stored internally and “Waiting for enable” is additionally displayed in the checkback signals. When the input is set, movement begins and the stored Start edge is deleted (a Stop likewise deletes the stored Start edge).

External block change	See Chapter 10
Set actual value on-the-fly	See Chapter 10 and Section 9.3.6
Measurement	See Section 9.3.10
Reference point switch for reference point approach	See Section 9.2.3
Reversing switch for reference point approach	See Section 9.2.3

9.8.2 Function description for digital outputs (Write request in the user DB, DBX39.4)

Output of PEH, FR+, FR–, SFG

The following checkback signals: position reached, stop (PEH), axis movement forward (FR+), axis movement in reverse (FR–), and enable Start (SFG), are additionally output via digital outputs. The output assignment is parameterized by way of MD35.

Change output M97 and M98

The change M function checkback signal (AMF) for M functions M97 and M98 can be output as a digital output (parameterization MD35). It allows these M functions (switching signals) to be applied without being delayed by the user cycle time.

Direct output

Outputs Q0...Q3 (D_OUT1...D_OUT4), which are defined in MD35 as “direct output”, can be used directly by the user program (user DB, DBX39.4) and can also be controlled by the FM 353.

Since the same memory is used in the user DB for Write request (user DB, DBX39.4) and Read request (user DB, DBX43.4), the jobs cannot be used simultaneously in the cycle.

Note

The outputs are subject to deactivation on module errors of error classes with the response “Everything Off”.

9.9 Software limit switches

Overview

To limit the working range, entries in the machine data (MD21 and MD22) specify the start and stop limit switches. These limit switches are active at synchronization of the axis.

If the limit switches are not needed, values lying outside the possible working range should be entered in the machine data (MD21 and M22), or monitoring should be switched off via the user program.



Warning

The software limit switches do not replace the hardware limit switches for EMERGENCY STOP responses.

Effect of software limit switches in modes

Jogging mode

At the limit switch the traveling movement is stopped in the limit-switch position, and an error is signaled.

Control mode

If the actual value is beyond the end position, the traveling movement is stopped and an error is signaled. The limit-switch position is overshoot by the amount of the necessary deceleration distance.

Reference-point approach mode

No effect.

Incremental relative, MDI, Automatic mode

Movement is stopped, or not even started, as soon as read-in of the set position reveals that the position lies outside the working range. An error is signaled.

The following special cases exist:

- Continuous travel (-) for Set Actual Value On-the-Fly (G88, see Chapter 10).
- Continuous travel (+) for Set Actual Value On-the-Fly (G88, see Chapter 10).

Effect of software limit switches in tracking mode

If the actual value is beyond the end position, an error is signaled.

Response after error

Leaving end position or traveling into working range after error

1. Acknowledge the error message!
2. Travel to the working range with the Jogging, Control, Incremental Relative or MDI mode.

Rotary axis

The end position of MD_{start} may be greater than MD_{stop}.

When traveling into the working range (e.g. end position was previously switched off), the shortest path is always chosen.

If both default values are parameterized the software limit switches are inactive.

9.10 Process interrupts

Overview

Process interrupts are interrupts that quickly signal states in the current process to the user program.

The appropriate setting in the machine data (MD5) specifies which signals are to be quickly communicated to the user program.

Process-interrupt generation

The process interrupt is generated by way of machine data item MD5:

MD	Designation	Significance
5	Process-interrupt generation (data type - bit field)	0 = Position reached 1 = Length measurement completed 3 = Change block on-the-fly 4 = Inprocess measurement

Hint to the user

You must program the interrupt processing routine in OB40.

The prerequisite is that process-interrupt signaling must have been activated as part of the environment definition (see Chapter 5).



10

Writing Traversing Programs

Chapter Overview

Section	Section Header	Page
10.1	Traversing blocks	10-2
10.2	Program execution and direction of processing	10-16
10.3	Block transitions	10-16

Overview

To execute the desired operations of the machine axis (sequence, position, etc.) in “Automatic” mode, the FM 353 needs certain information. This information is programmed with “Parameterize FM 353” (traversing program creation) in the form of a traversing program, based in principle on DIN 66025.

Traversing programs

Each traversing program is stored under a program number.

A traversing program consists of not more than 100 traversing blocks.

The program number and traversing blocks are converted to an internal format (see Section 9.3.12), are stored in the appropriate data block, and are transferred to the module, where they are administered.

The possible number of programs depends on the amount of memory available (max. 16 Kbytes) and on the length of the individual programs.

Program length in bytes: $108 + (20 \times \text{no. of traversing blocks})$

Program name

Any program can be assigned a name (optional).

The program name may have up to 18 characters, and is saved with the program.

Program number

Programs may be numbered from % 1 to % 199.

Traversing block

A traversing block contains all the data required to perform a machining step.

Program structure

A program consists of several blocks. Each block number occurs only once, and numbers are arranged in ascending order.

A sample program structure follows:

/	N	G1	G2	G3	X/t	F	M1	M2	M3	D	L	P	
	5	90			500 000	100 000	10						Start of program = lowest block number
	6	91									
	7	...											
	45												
	46						2						End of program = M2 or M30

10.1 Traversing blocks

Block structure

The following Figure gives you an overview of the structure of traversing blocks.

/	N	G1	G2	G3	X/t	F	M1	M2	M3	D	L	P
---	---	----	----	----	-----	---	----	----	----	---	---	---

- / - Identifier for skipped block
 - N - Block number
 - G1 - G function of first function group
 - G2 - G function of second function group
 - G3 - G function of third function group
 - X/t - Position/dwell time
 - F - Speed
 - M1 - M function of first function group
 - M2 - M function of second function group
 - M3 - M function of third function group
 - D - Tool offset number
 - L - Call a program as a subprogram
 - P - Number of subprogram runs
- } see Table 10-1
- } see Table 10-2

Skip block /

Program blocks which are not to be executed every time the program runs can be identified as skippable blocks by an oblique “/”. When the program is being processed, the “Skip block” control signal can be used to decide whether skippable blocks are to be skipped. The last block may not be skipped.

Block number N

The program is executed in ascending order of block numbers (1 to 255) or in descending order if executed in reverse.

G function group 1 – 3

In each traversing block only one G function may be entered from each G function group.

The following figure shows an example.

/	N	G1	G2	G3	X/t	F	M1	M2	M3	D
	10	90	34	43	100 000	400 00				10

G functions

Table 10-1 lists the possible G functions and the individual G function groups.

Table 10-1 G functions

GNo.	G Function	G Function group
04 ¹⁾	Dwell time	1
87	Turn off measuring system shift for Set Actual Value On-the-Fly	
88 ¹⁾	Continuous travel for (-) for Set Actual Value On-the-Fly	
89 ¹⁾	Continuous travel for (+) for Set Actual Value On-the-Fly	
90	Absolute dimensions	
91	Incremental dimensions	
30	100% override on acceleration/deceleration	2
31	10% override on acceleration/deceleration	
32	20% override on acceleration/deceleration	
.	.	
.	.	
39	90% override on acceleration/deceleration	

Table 10-1 G functions, continued

GNo.	G Function	G Function group
43	Tool offset (+)	3
44	Tool offset (-)	
50 ¹⁾	External block change	
60	Exact stop block change	
64	Set actual value on-the-fly, continuous-path mode	

1) These G functions take effect only on a block-by-block basis. The other G functions remain active until canceled explicitly.

G30, G90 and G64 are the **initial settings** after the start of the program.

Dwell G04

A traversing block with dwell can only contain M functions and the time parameter apart from this G function.

The following applies for dwell time:

Name	Lower input limit	Upper input limit	Unit
Dwell time	2	100,000	ms

Odd input values are rounded upward. Dwell times take effect only on a block-by-block basis.

If no value is input for G04 in the block, the lower input limit applies.

Block change G60, G64 (approach conditions)

With G60, the exact programmed position is approached and the feed movement is stopped (exact stop block change).

G64 causes the next block to be processed immediately as soon as the point of deceleration is reached (change block on-the-fly).

G60 and G64 are mutually exclusive and modal.

M commands have no effect on G64 operation.

(For a detailed description, see Section 10.3).

External block change (G50) with delete residual path

The “external block change” function causes a block change on-the-fly triggered by a digital input. The fast input must be parameterized with the “External block change” function by way of machine data item MD34.

The function takes effect only on a block-by-block basis (no effect on G60 and G64).

Example of external block change

The following figures show the program structure and program flow of an example of "External block change."

/	N	G1	G2	G3	X/t	F	M1	M2	M3	D
	10			50	10 000	1 000				
	20				12 000	1 300				

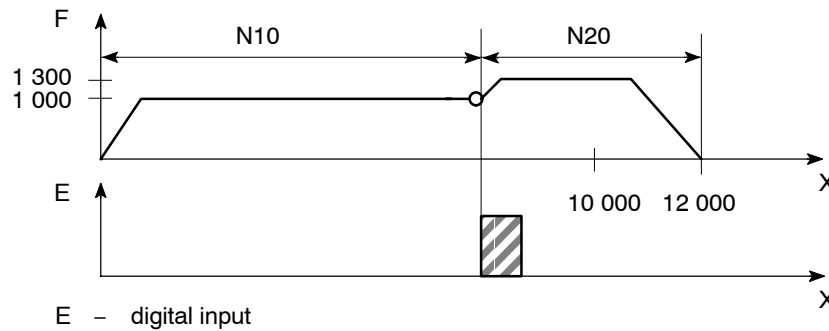

Notes to the example of external block change

The axis travels until a signal change from 0 to 1 takes place at the digital input. This triggers two reactions:

- A block change on-the-fly, and thus immediate processing of block N20.
- Storage of the actual position at the time of this signal change to "Actual value block change." This position is also the starting position for any subsequent incremental programming.

Depending on the situation, N20 is processed as follows:

- If the block position in N20 is less than the actual position at the time when the digital input is received (reversal of direction), the equipment is stopped so that the position can then be approached in the opposite direction.
- If no position is programmed in block N20, movement is braked, the functions programmed in N20 are executed, and processing then moves on to the next block (except if the block contains M0, M2 or M30).
- If the programmed path in block N20 is less than the deceleration distance, the programmed position is overshoot and then positioned by a reversal of direction.

If no signal change occurs at the digital input, the target position of N10 is approached, with the following additional response:

When the target position is reached, the error message "Digital input not actuated" is output (see Table 11-5, Class 2 No. 15).

Set actual value on-the-fly G87, G88, G89

The “Set actual value on-the-fly” function is programmed and triggered by a digital input; the block change occurs on the fly and the actual value is set to a new dimension (programmed coordinate) at the same time. The digital input must be parameterized with the “Set actual value on-the-fly” function by way of machine data item MD34.

Example of set actual value on-the-fly

The following figures show the program structure, program flow and actual-value curve for an example of “Set actual value on-the-fly.”

/	N	G1	G2	G3	X/t	F	M1	M2	M3	D
	10	90			100	400 000				
	15	89 (88)			50	200 000				
	20	90			300	400 000				
	25	87			400	400 000				

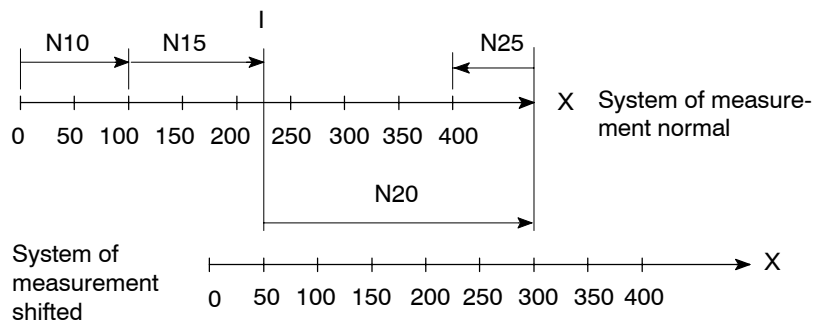
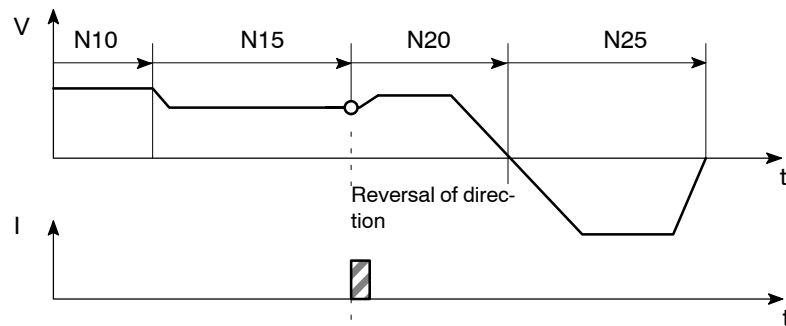

I - digital input

Notes to the example of set actual value on-the-fly

This changes blocks on-the-fly from N10 to N15, with G89 causing movement in a positive direction and G88 causing movement in a negative direction at the speed programmed in N15.

The axis now travels in the specified direction until a positive edge change occurs at the digital input. This triggers the following responses:

- Block change on-the-fly and immediate processing of block N20
- Set actual value on-the-fly to the block position from N15 (50 in the example), and resulting shift of the coordinate system
- Save current actual value.

The programmed position in block N20 refers to the shifted coordinate system.

At the block change from N20 to N25, G87 cancels the shift of the coordinate system and causes reference-measure programming to the block position of N25.

The saved actual value can be read out with “Actual value block change.”

The shift of the coordinate system is maintained until it is canceled by G87 or by a mode change. It is possible to use the existing shift of the coordinate system in different programs. The coordinate system can be shifted again without previously canceling an existing coordinate system shift.

G88, G89 can be programmed multiple times. The shift in each case refers to the original state. The software limit switches are always shifted concurrently.

If the signal change of the digital input does not occur, the axis runs until it reaches the limit switch.

Note

The G functions G87, G88 and G89 take effect only on a block-by-block basis and must be reselected if necessary.

Dimensions G90, G91

The traversing movement at a specific point can be described by

- Absolute measure input G90 or
- Relative measure input G91

You can switch back and forth at will between absolute and incremental input.

The status at startup is reference-measure programming, G90.

G90 and G91 are modal.

Absolute dimensioning G90

Absolute dimensioning is the method used to specify dimensions that generally refer to the coordinate system.

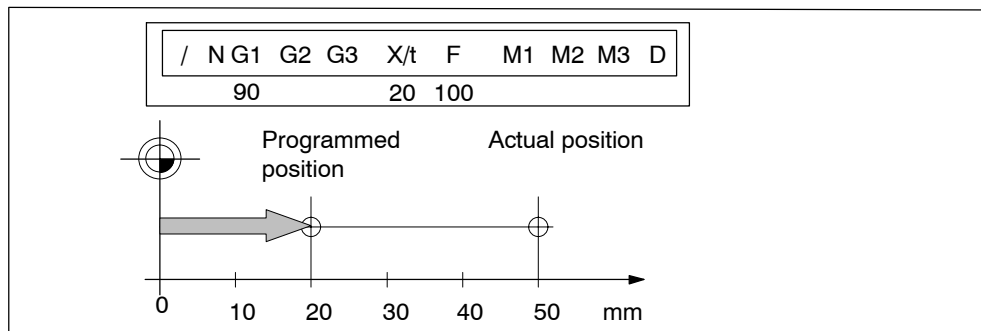

Fig. 10-1 Reference-measure input G90

Note

To ensure precise reproduction of the program, the first block should contain reference-measure programming.

Incremental dimensioning G91

Incremental dimensioning is the method used to specify incremental dimensions that refer to the last actual position.

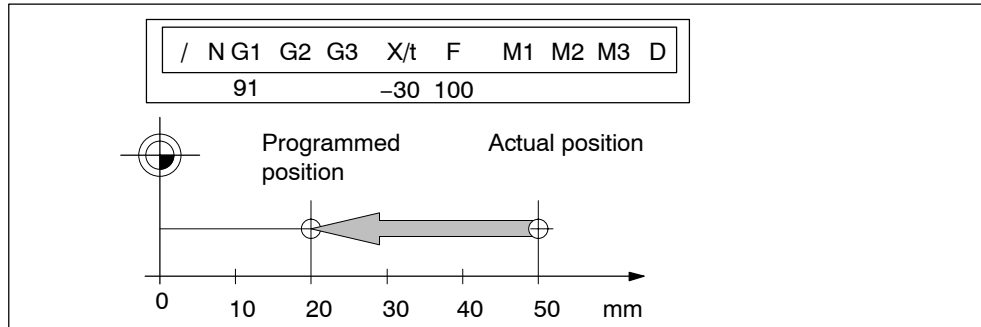

Fig. 10-2 Incremental input G91

Axis as rotary axis

If the axis is operated as a rotary axis, the measuring system must be adjusted in such a way that the measurement scale refers to the full circle (e.g. 0° and 360°).

- Reference-measure input G90

In a full circle with 360°, reference-measure programming (G90) has the peculiarity that there are always two options for reaching the set position.

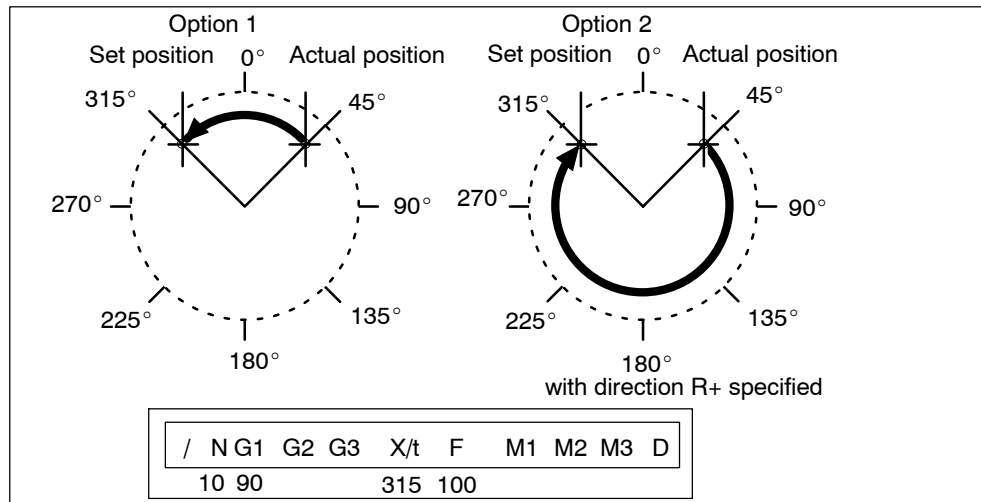

Fig. 10-3 Rotary axis

Option 1:

With G90, the axis autonomously always takes the shortest path to reach the set position of 45°, going via 0° to 315°.

Option 2:

The control signals (R+) or (R-) force the respective direction of the axis - in this example 45° via 180° to 315°. (R+) or (R-) must already be pending when positioning is activated (START).

Note

The direction (R+) or (R-) must be specified sufficiently in advance. A traversing direction **cannot** be forced on a traversing block that is already active, or on the traversing blocks (up to 4) that have already been calculated in advance in G64 operation.

Operation with option 1 or option 2 is at the user's discretion.

- Incremental input G91

With incremental programming G91, the direction of rotation of the rotary axis is defined by the sign of the position setpoint. Multiple rotations can be programmed by setting a value $> 360^\circ$ as the position setpoint.

Acceleraton override G30...G39

The acceleration override is used to control acceleration and deceleration during positioning movements. The acceleration and deceleration values are set by machine data. G30 through G39 in the traversing block can be used to achieve a percentage reduction in both values. These functions are modal.

G Function

30	100% override for acceleration/deceleration
31	10% override for acceleration/deceleration
to	
39	90% override for acceleration/deceleration

Changing the acceleration override in the program prevents block change on-the-fly. Consequently G60 response is forced in the preceding block.

The acceleration override is turned off by:

- Mode changes
- Resetting the axis with a Restart (single command)
- Changing or ending the program.

Tool compensation G43, G44

Tool compensation allows you to continue using an existing machining program, even when the tool dimensions have changed.

Tool offset is selected with G43 or G44, as applicable, and the tool offset number D1 – D20. Tool offset is turned off with G43 or G44, as applicable, and the tool offset number D0.

A total of 20 tool offset storage areas and tool wear storage areas are available. The values are loaded to the module with the "Tool offset data" data block and are saved permanently. When selected, changed or turned off, the tool offset is not taken into account until the next positioning action.

A selected tool offset is maintained in effect until it is either turned off or replaced with a new one. Likewise a mode or program change, or the end of a program, will turn tool offset off.

Variants in tool offset

Tool offset is made up of two correction-value components:

- Tool length offset

The tool length offset is the actual tool length from tool zero to the tool tip.

- Tool length wear value

The tool length wear value allows the change in tool length due to wear to be compensated in two ways:

Absolutely: by specifying a fixed wear value

Additively: by adding an “offset value” to the current tool length wear value contents.

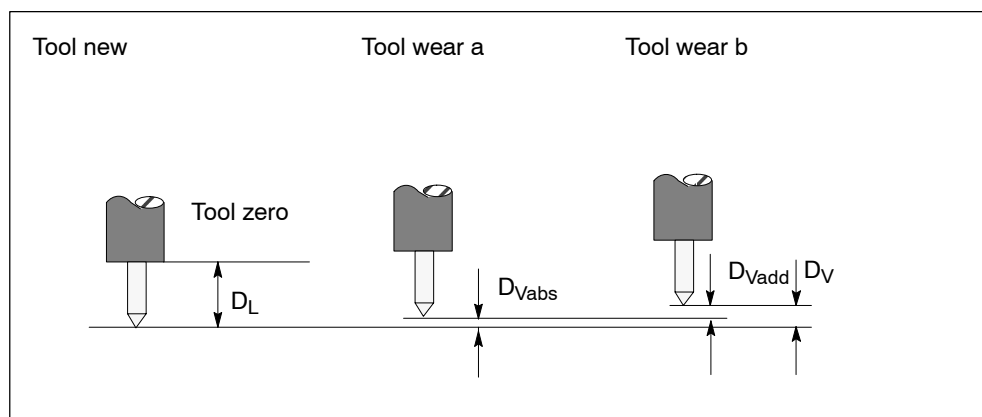

Fig. 10-4 Tool offset

Notes to the figure:

The tool offset thus consists of the tool length compensation and the tool length wear value:

$$D = D_L - D_V$$

$$D_V = D_{Vabs} + D_{Vadd}$$

- D – Tool compensation
- D_L – Tool length compensation (positive or negative)
- D_V – Tool length wear value (positive or negative)
- D_{Vabs} – Wear, absolute (positive or negative)
- D_{Vadd} – Wear, additive (positive or negative)

If the additive wear is modified on-line, the FM computes the new absolute wear and resets the additive wear to zero.

Direction of tool offset

The functions G44 (-) and G43 (+) correct the position value in such a way that the tool tip reaches the programmed set position.

- **Negative tool offset G44**

As a rule, the tool points to the workpiece in a negative direction. With the infeed adjustment, the positioning value (traversing path) becomes smaller.

Referred to the measuring system, the following position is thus approached:

$$X_{ms} = X_{set} + (D)$$

X_{ms} – Position of measuring system

X_{set} – Programmed set position

D – Tool offset

- **Positive tool offset G43**

The positioning value (traversing path) becomes greater with the infeed adjustment. The position value is corrected by:

$$X_{ms} = X_{set} - (D)$$

To program a tool offset in the traversing block, at least the tool length offset must be input. If no correction is to be applied even when the function has been selected, the tool length offset and tool length wear value must be preset to 0.

A tool length wear value can be deleted by an absolute input of 0.

Position X

Positions may be input with a negative or positive sign. The plus sign on positive values may be omitted.

Name	Lower input limit	Upper input limit	Unit
Position	- 1,000,000,000	+ 1,000,000,000	MSR from MD7

Speed F

The input speed is calculated against the override. If the speed value is numerically greater than the maximum allowed speed, it is limited to the magnitude of the machine data item. Speeds are modal and need to be re-input only when changed.

Name	Lower input limit	Upper input limit	Unit
Speed	10	500 000 000	MSR from MD7/min

M functions

Up to three M functions can be programmed in one traversing block, with any assignment of M1, M2 and M3. The output sequence of the M functions is always M1→M2→M3 (for information about output see Section 9.1).

The following figure shows an example.

/	N	G1	G2	G3	X/t	F	M1	M2	M3	D
	10	90	34	43	100 000	400 00	10	11	12	1

Table 10-2 M functions

M No.	M Function	M Function group
0	Stop at end of block	1, 2, 3
2, 30	End of program	
1, 3...17	User functions	
18	Endless loop (skip back to start of program)	
19...29, 31...96	User functions	
97, 98	Change signal programmable as digital output	
99	User functions	

M0, M2, M18 and M30 are always output at the end of the traversing movement.

M0, M2, M18 and M30 are mutually exclusive within a single block.

Stop at end of block M0

If M no. 0 is programmed in a traversing block, the program stops at the end of the traversing block and M0 is output. Only a new START edge causes the traversing program to be continued.

End of program M2, M30

If M2 or M30 is programmed in a block, then after positioning is complete the M function is output with a subsequent programmed stop and a jump back to the start of the program. The Start edge can restart the program. M2 or M30 is always the last output in the block.

If the program is called up as a subprogram, the action skips to the main program. In this case M2 or M30 is not output.

Infinite loop M18

M18 is always output as the last M function in the block.

Two cases are distinguished:

- M function M18 is output like any other M function. Only after the block has been processed all the way to the end (including M18) does the axis skip back to the start of the program.
- If M function M18 is programmed alone in the last block of a traversing program, the M function is not output, and the axis immediately skips back to the start of the program.

Change signal programmable as digital output M97, M98

If M97 or M98 is programmed in a block, the M function output proceeds via the digital outputs as defined in machine data item MD35, in the same way as the checkback signals.

Tool offset number D

Twenty tool offset numbers (D1 – D20) are available. D0 in conjunction with G43 or G44 causes the tool offset to be switched off. The offset values must previously have been loaded to the module. Nonstandard offset values have a value 0.

Subprogram call P, L

A block with a subprogram call (P is the “number of runs”, L is the “program number”) cannot contain any further information.

A maximum of 19 subroutines can be called up in one program. Nesting is not possible.

Name	Lower input limit	Upper input limit
P = Number of subprogram runs	1	250

10.2 Program execution and direction of processing

Forward processing

As a rule, programs are processed by ascending block number.

Reverse processing

If programs are processed in reverse, the effects of commands must be taken into account in the programming:

- Commands are modal (G90, G91, G60, G64, G30 – G39)
- Active tool offset (G43, G44, D0 – D20)
- Change of coordinate systems via G87, G88, G89.

For these reasons, a distinction can be made between forward processing and reverse processing, in terms of both geometry and block transition response.

10.3 Block transitions

Overview

This chapter describes the influence of certain commands on block transitions.

Exact positioning - G60

G60 mode is overlaid with G50 and G88 to G89 (force block change on-the-fly).

The program advances to the next block when the target range is reached.

The influence of M functions is as indicated in machine data item MD32.

Output of M function before positioning

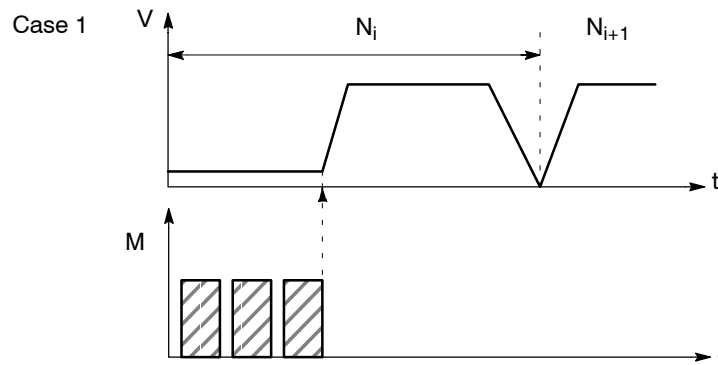

Output of M function during positioning

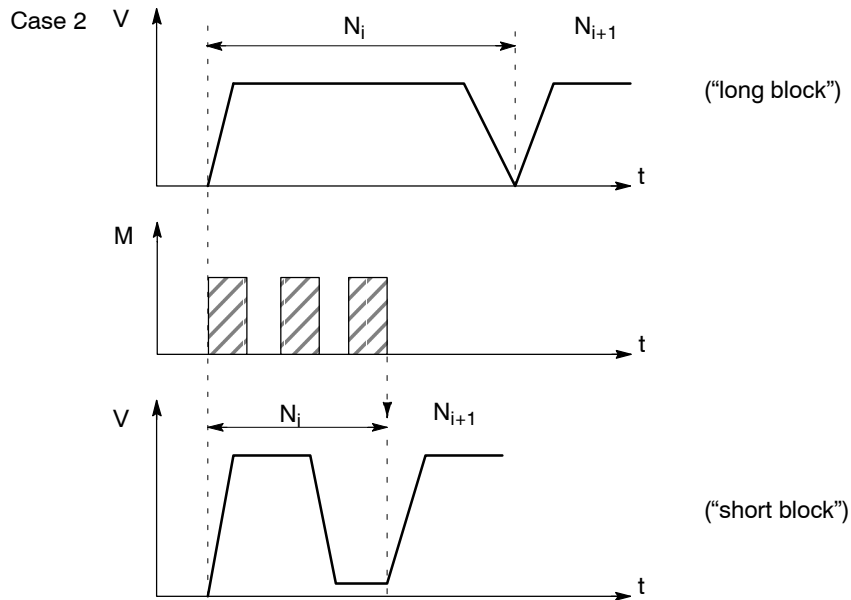

Output of M function after positioning

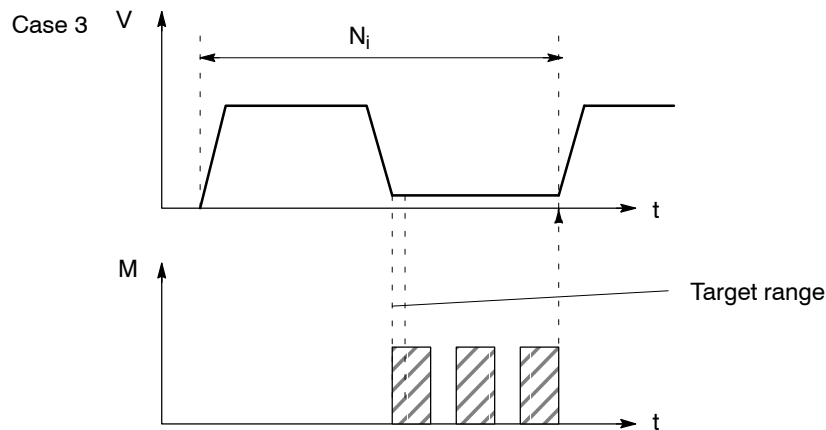

Change block on-the-fly - G64 (standard case)

Changing from one traversing block to the next proceeds without stopping the axis.

The acceleration and braking function is calculated for multiple blocks when the G64 function is programmed. The number of blocks processed in advance is three.

When the block changes, the feed rate is changed in such a way that a higher speed from a preceding block is never carried over into the next block, and a higher speed from a following block never goes into effect while a given block is still traversing its own path. This means that acceleration does not begin until the starting point of the block, and deceleration to a lower speed for a following block is initiated as with G60. When the speed of the following block is reached, the residual distance in the current block is processed at the feed rate of the following block.

Sample programming (standard case)

The following figure shows a sample program with the programming flow.

/	N	G1	G2	G3	X/t	F	M1	M2	M3	D
	5	90		64	10 000	100 00				
	10				20 000					
	15				30 000	200 00				
	20				40 000	150 00				
	25			64	30 000	100 00				

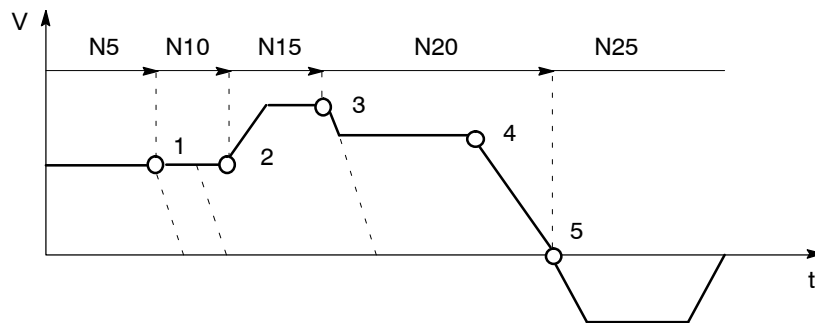

- 1 – Block N10 is started at the point of deceleration of N5.
- 2 – N15 is started at the point of deceleration of N10. Acceleration to the higher traversing speed begins when the set position of N10 is reached.
- 3 – N20 is started at a lower traversing speed at the braking point of N15.
- 4 – When the traversing direction is changed, the axis decelerates to a standstill.
- 5 – When the target range is reached, the axis accelerates in the opposite direction up to the traversing speed of the new block.

To be able to approach a position correctly, the axis must calculate the point of deceleration. The relevant parameters for this calculation are the residual traversing distance, the deceleration value and the current traversing speed.

The point of deceleration is also the earliest possible time for a block change.

Change block on-the-fly - G64 (deceleration)

There are a number of conditions that may delay or prevent a block change on-the-fly. Here a distinction is necessary between the case in which this type of block change is suppressed intentionally, and the case in which the selected function does not permit a block change on-the-fly.

- Block change on-the-fly is suppressed:
 - By removing the Enable read-in control signal - this stops program processing at the end of the current block. To continue the program, the enable must be re-input.
 - By output of the M function before or after positioning.
 - By M function M0 (stop at end of block). To continue the program, the START control signal must be reset.
 - By a block with a dwell time.
 - By processing a program in the Automatic/Single Block mode. Each block must be activated individually.
 - By a change in the acceleration override.
- Functions that themselves prevent block change on-the-fly:
 - M functions (during positioning).

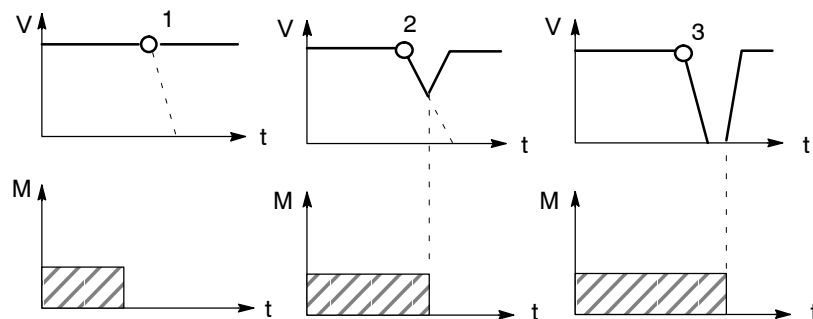

- 1 – Since the M output is completed at the point of deceleration, a block change takes place on-the-fly.
- 2 – The M output is not yet complete at the point of deceleration. The axis begins to brake. At the end of the M output, the axis returns to speed (transition on-the-fly from deceleration ramp to acceleration ramp).
- 3 – Axis comes to a complete standstill and waits for the end of M output.

Influence of M function on block change on-the-fly

Machine data can specify the output time for M functions:

- M function is output before or after positioning with a block change
 - M-function output and positioning proceed in alternation.
 - M function output before positioning causes exact-positioning response in the preceding block.
 - M function output after positioning causes exact-positioning response within the block.
- M function is output during positioning

M-function output and positioning proceed simultaneously.

The following figure shows a sample program with M function output “during positioning”.

/	N	G1	G2	G3	X/t	F	M1	M2	M3	D
	5	90			10 000	100 00	10			
	10				20 000		20			
	15				30 000		30	40		
	20			60	40 000					97

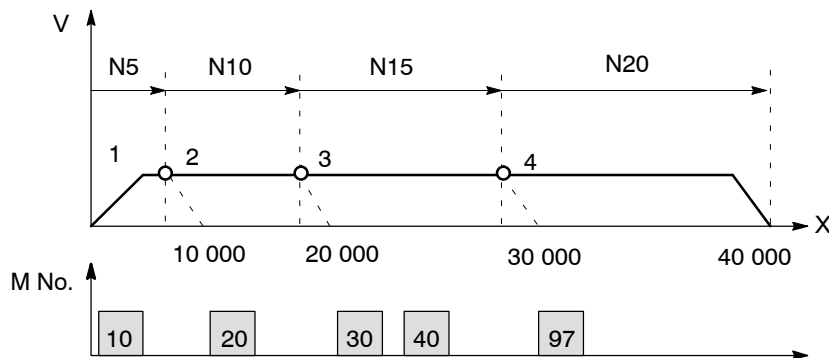

- 1 – Output of M10 is **not** position-dependent, since no relevant position for a position dependent M function is present.
- 2 – At the block change from N5 to N10, output is prepared. The axis the M function does not proceed until the actual position has reached the programmed position of N5.
- 3 – If two M functions are programmed in a traversing block, the first M function is output depending on position, followed by the second M function.
- 4 – The change signal for M97 or M98 is output with the G64 block transition (digital output) if the actual position has reached the programmed position of the block. The actual position runs behind the set position (difference = overtravel).



Troubleshooting

11

Chapter Overview

Section	Section Header	Page
11.1	Error classes and module responses	11-3
11.2	Error messages	11-4
11.3	Error lists	11-9

Overview

The FM 353 provides diagnostics for the following:

- I/Os
- Module processes

This chapter “Troubleshooting” describes the different types of errors, their cause, effect and elimination.

Error localization

The FM 353 distinguishes according to the following criteria:

- Errors which trigger a diagnostic interrupt in the CPU, and
- Errors which the module reports by way of checkback messages.

In the event of diagnostic interrupt, STATUS LEDs light up in addition.

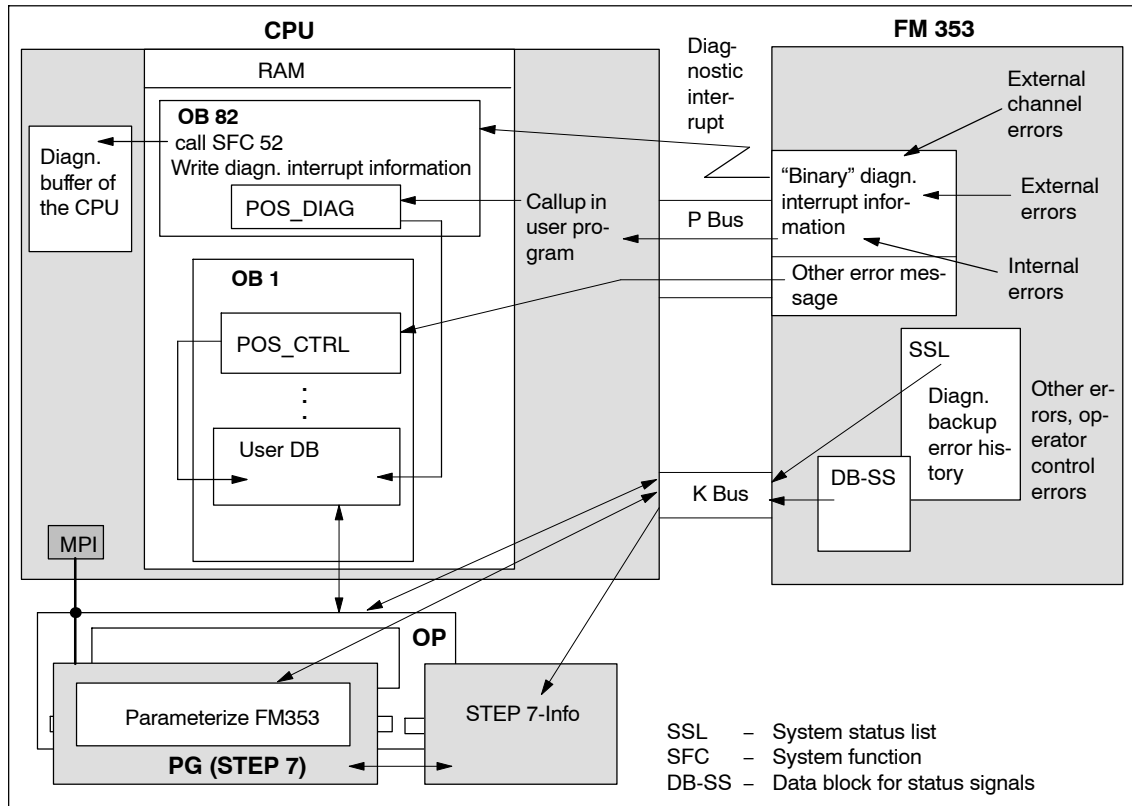

Fig. 11-1 Overview of diagnostics/errors

Error evaluation by software

The following manuals describe how to include diagnostics-capable modules in your user program, and how to evaluate the diagnostic messages:

- Programming manual *System Software for S7-300/400; Program Design* (OB Types, Diagnostic Interrupt OB 82)
- Reference manual *System Software for S7-300/400; System and Standard Functions*

A basic description of the diagnostic system of the S7-300 can be found in the user manual *Standard Software for S7 and M7, STEP 7*.

11.1 Error classes and module responses

Overview

The FM 353 contains monitoring circuits which are active during startup or during continuous operation. Errors occurring during those times are reported to the system and to the user program.

The table below lists the error classes and their meaning.

Table 11-1 Error classes, overview

Message	Error class	Response	Significance
Diagnostic interrupt	Internal errors	Everything OFF	... are hardware faults in the module which are discovered by diagnostics routines (e.g. memory errors). (see Section 6.3.4 for diagnostic interrupt data and error list, Table 11-4)
	External errors		... are errors which can occur due to faulty module connection (e.g. parameters for initialization of module MPI station numbers are missing or are incorrect). (see Section 6.3.4 for diagnostic interrupt data and error list, Table 11-4)
	External channel errors		... are measurement system errors or errors which can occur by connecting the digital outputs or during operation (operator control errors) of the FM 353 (e.g. cable break, incremental value encoder). (see Section 6.3.4 for diagnostic interrupt data and error list, Tables 11-4 and 11-5)
Checkback signals	Operator control and travel errors	Feed STOP	... are errors (operator/travel errors) which can occur during operator inputs to the FM 353 (e.g. direction signals R+ and R- set at the same time, see Error List, Tables 11-6 and 11-7).
	Data errors	Warning!	... are errors (data, machine data and traversing program errors) which are detected on interpretation of invalid data (see Error List, Table 11-8).

Error response

Each error message triggers an appropriate response.

Table 11-2 Overview of internal error responses

Error response	Significance
Everything OFF	<ul style="list-style-type: none"> • Stop movement by way of voltage ramp (MD44/MD45) • Disable digital outputs • Deactivate controller enable • SYN is cleared after the error has been acknowledged with Restart • No new travel jobs possible
Feed STOP	<ul style="list-style-type: none"> • Stop movement • Travel job is canceled and terminated. • No new travel jobs possible
Warning	<ul style="list-style-type: none"> • Message only • Movement and control of axes not affected

11.2 Error messages

Introduction

The following approaches to error localization are available for the FM 353:

- Error display by LEDs
- Error messages to the system and to the user program

11.2.1 Fault indication by LED

Status and error displays

The FM 353 features the following status and error displays:

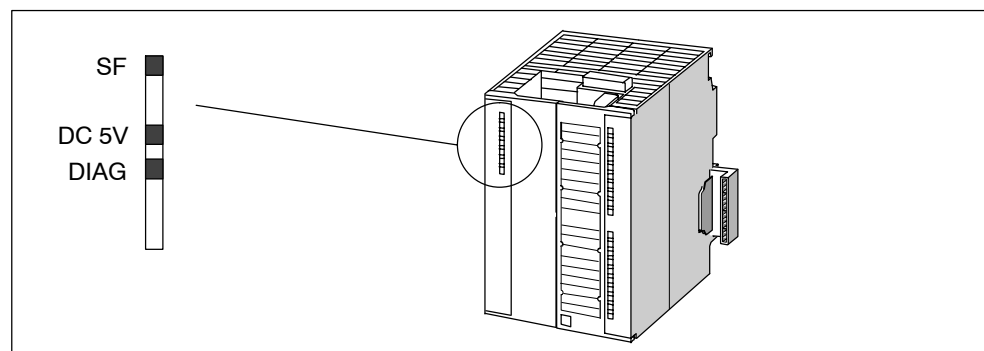

Fig. 11-2 Status and error displays of the FM 353

Meaning of the status and error displays

The status and error displays are explained in the order in which they are arranged on the FM 353.

Table 11-3 Status and error displays

Display	Meaning	Explanations
SF (red) LED-ON	Group errors	This LED indicates an error condition in the FM 353. Diagnostic interrupt (internal error, external error or external channel error) To eliminate the error see Error List, Table 11-4.
5 V DC (green)	Power supply switched on	This LED indicates that the hardware is ready for operation. If not illuminated, this may indicate one of the following conditions: <ul style="list-style-type: none"> Your line voltage is not OK. Load current supply is faulty. Module is incorrectly connected. Your control circuit is configured incorrectly (sum of rated and starting currents is too great), or The module is faulty.
DIAG (yellow) LED-ON LED-blinking	Diagnostics	This LED indicates the various diagnostic conditions. Diagnostic interrupt (external channel error). To eliminate the error see Error List, Table 11-4. If this LED blinks when the LED "SF" is simultaneously activated, this indicates a system error. If this occurs, then please consult the appropriate sales department. The exact circumstances which resulted in the error are of major importance in this case.

11.2.2 Diagnostic interrupts

Overview

Internal errors, external errors and external channel errors are indicated to an interrupt-capable system by means of diagnostic interrupts (see diagnostic interrupt data in Tables 11-4, 11-5 and Section 6.3.4). This presupposes that the diagnostic interrupt message was activated at the time of configuration (see Chapter 5). If the system is not interrupt-capable, the diagnostic interrupt information must be read out cyclically with POS_DIAG.

Error class	Coding	Message
Internal errors	Byte-.Bit-No. 0.1 Group error byte 2, 3	LED "SF"
External errors	Byte-.Bit-No. 0.2	LED "SF" and "DIAG"
External channel errors	Byte-.Bit-No. 0.2, 0.3 Group error byte 8	LED "SF" and "DIAG"

A diagnostic interrupt is reported by the FM 353 as "incoming" or "outgoing".

Diagnostic interrupt				
Message to the CPU (precondition: interrupt message activated (see Section 5.2))			Message in the "troubleshooting" display of "Parameterize FM353" Menu: Test > Troubleshooting	Entry in diagnostic buffer
No OB 82 exists → CPU switches to STOP	OB 82			
	Enters the diagnostic information in the diagnostic buffer of the CPU (4 bytes) and calls SFC 52	Enters the diagnostic information in the user DB starting at address 70 and calls POS_DIAG	Calls POS_DIAG	

Interrupt acknowledgement

If processing is to continue after a diagnostic interrupt, the diagnostic interrupt has to be acknowledged with a restart (user DB, DBX37.5) when the error has been remedied.

Internal errors cannot be acknowledged. External errors are self-acknowledging.

11.2.3 Error messages in checkback signals

Overview

Operator/travel errors [BF/FS] and data errors/machine data errors/traversing program errors [DF], are communicated to the user by way of checkback signals (call of the POS_CTRL block) and operating errors by means of diagnostic interrupts (see Section 6.3.4). The error-specification is stored in the form of an error number (see error list in Table 11-6...11-8).

Error acknowledgement

Set/clear control signal [BFQ/FSQ]
 or
 on message [DF] → write a new write job

Note

Invalid data are not accepted. The original data are retained.

Reading out the error number

The errors are identified by the detail event class (DEKL) and the detail event number (DENR).

Error technology class	DEKL	DENR	Message
Operator control error	1	1 – n	Diagnostic interrupt
Operator errors	2	1 – n	Checkback signals
Travel errors	3	1 – n	Checkback signals
Data error	4	1 – n	Checkback signals
Machine data errors	5	1 – n	or
Traversing program errors	8	1 – n	Data block

11.2.4 Message in data block

Overview

Please note the following for direct access to DBs (e.g. using an OP).

If data errors/machine data errors/traversing program errors are detected when the parameters are written to the data block (e.g. in the parameterization tool), an error message is stored in the data block. The error-specification is stored in the form of an error number in the corresponding data block (see error list in Table 11-8). The error message occurs each time the data block is written to until the cause has been eliminated.

It is recommended to scan the error message after every write operation.

11.2.5 Viewing the diagnostic buffer (PG/PC)

Overview

The last five error messages are stored in the diagnostic buffer.

There are two ways of proceeding:

1. In the **S7 SIMATIC Manager** select the menu **File > Open > Accessible Nodes**.
2. In the **Accessible Nodes** window, select the MPI address of your module.
3. You can view the diagnostic buffer in the menu **Target system > Module status**

or

1. Open your project in the **S7 SIMATIC Manager**.
2. Select the menu **View > Online**.
3. In the dialog box, select the FM 353 and the associated program.
4. You can view the diagnostic buffer in the menu **Target system > Module status**

11.3 Error lists

Note

In the following tables, please note:

The module response described under “Effect” refers to the error-specific module response. The error response described in Table 11-2 occurs in addition.

11.3.1 Diagnostic interrupts

Overview

The diagnostic interrupts are listed according to error class in Tables 11-4, 11-5.

Table 11-4 Diagnostic interrupt

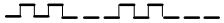
Byte. Bit	Error message, error analysis and remedy	Message/ Display
0.1	Internal errors	Error response: “Everything Off”, as in Table 11-2
2.1 (8031)	Communication disturbance	
	Cause	MPI/K-bus communication fault caused by unknown event
	Effect	MPI interface inactive
	Elimination	<ul style="list-style-type: none"> • Check connection • Check programming device/CPU • Switch module on/off • Replace module
2.3 (8033)	Internal time monitoring circuit (Watchdog)	
	Cause	<ul style="list-style-type: none"> • Pronounced noise conditions on the FM 353 • Errors in the FM 353
	Effect	<ul style="list-style-type: none"> • Deactivate entire FM 353 • LED indicators: SF: ON <p style="text-align: center;">DIAG: Flashing cycle </p>
	Elimination	<ul style="list-style-type: none"> • If this manual is observed, the errors should not occur <p>However, should this still be the case, please consult the responsible sales department. When doing so, it is vitally important to also report the exact circumstances leading to the error.</p> <ul style="list-style-type: none"> • Replace the FM 353

Note: (xxxx) value = Hexadecimal notation in diagnostic buffer

Table 11-4 Diagnostic interrupt, continued

Byte. Bit	Error message, error analysis and remedy		Message/ Display
0.1	Internal errors	Error response: "Everything Off", as in Table 11-2	
2.4 (8034)	Internal module power supply failure		SF <input type="checkbox"/> DC5V <input type="checkbox"/> DIAG <input type="checkbox"/>
	Cause	<ul style="list-style-type: none"> • Drastic voltage dip • FM 353 power supply faulty 	
	Effect	Deactivate entire FM 353	
	Elimination	<ul style="list-style-type: none"> • Check FM 353 power connection • If FM 353 power supply defective, replace FM 353 	
3.2 (8042)	FEPROM errors		SF <input checked="" type="checkbox"/> DC5V <input checked="" type="checkbox"/> DIAG <input type="checkbox"/>
	Cause	Memory for firmware code faulty	
	Effect		
	Elimination	Replace the FM 353	
3.3 (8043)	RAM errors		
	Cause	<ul style="list-style-type: none"> • Faulty RAM data memory • Faulty flash-EEPROM data memory 	
	Effect		
	Elimination	Replace the FM 353	
3.6 (8046)	Process interrupt lost		
	Cause	<ul style="list-style-type: none"> • A process interrupt event was detected by the FM 353 and cannot be reported, because the same event has not yet been acknowledged by the user program/CPU. • Faults on backplane bus 	
	Effect		
	Elimination	<ul style="list-style-type: none"> • Incorporate OB40 into user program • Check bus connection of the module • Deactivate using MD5 process interrupt 	
0.2	External errors	Error response: "Everything Off", as in Table 11-2	
0.6 (8006)	Module not parameterized		SF <input checked="" type="checkbox"/> DC5V <input checked="" type="checkbox"/> DIAG <input type="checkbox"/>
	Cause	No MPI parameterization data received from the CPU	
	Effect	MPI interface is initialized with default values. MPI address = 12	
	Elimination	Check parameterization, see S7-300 description	

Note: (xxxx) value = Hexadecimal notation in diagnostic buffer

Table 11-4 Diagnostic interrupt, continued

Byte. Bit	Error message, error analysis and remedy	Message/ Display
0.2, 0.3 External channel errors Error response: "Everything Off", as in Table 11-2		
8.2 (8092)	Zero marker missing	
	Cause	In "reference point approach" operating mode, no zero marker was detected within one motor revolution after the reference point switch was passed.
	Effect	
	Elimination	Check connection.
8.7 (8097)	For operating errors, see Table 11-5	

SF
DC5V
DIAG

Note: (xxxx) value = Hexadecimal notation in diagnostic buffer

Table 11-5 Operating errors

Cl.	No.	Error message, error analysis and remedy	Message/ Display
Operating errors Error response: "Everything Off", as in Table 11-2			
1 (01)	1 (01)	Software limit switch, beginning is passed	
		Cause	Limit switch passed: in "Control" operating mode
		Effect	<ul style="list-style-type: none"> The limit switch position is passed by the necessary stopping distance. Set actual value is not executed.
		Elimination	<ul style="list-style-type: none"> Following acknowledgment of the error, it is possible to traverse to the working range. Alter value of software limit switch (MD21) Switch off monitoring limit switch occasionally!  <p>(With the limit switches (MD21/22) disabled, the travel range limits are established by the maximum allowable values for the limit switches).</p>
			Diagnostic interrupt

Cl. = Detail event class, No. = Detail event number

Note: Value (xx) = Hexadecimal notation of the error number

Table 11-5 Operating errors, continued

Cl.	No.	Error message, error analysis and remedy	Message/Display	
Operating errors		Error response: "Everything Off", as in Table 11-2		
1 (01)	2 (02)	Software limit switches, end is passed		Diagnostic interrupt
		Cause	Limit switch passed: in "Control" operating mode	
		Effect	<ul style="list-style-type: none"> The limit switch position is passed by the necessary stopping distance. Set actual value is not executed. 	
		Elimination	<ul style="list-style-type: none"> Following acknowledgment of the error, it is possible to traverse to the working range. Alter value of software limit switch (MD22) Switch off monitoring limit switch occasionally!  <p>(With the limit switches (MD21/22) disabled, the travel range limits are established by the maximum allowable values for the limit switches).</p>	
1 (01)	3 (03)	Beginning of traversing range passed		Diagnostic interrupt
		Cause	When operating in "Control" operating mode with soft limits disabled, the traversing range beginning was passed.	
		Effect	The limit switch position is passed by the necessary stopping distance.	
1 (01)	4 (04)	Traversing range end passed		Diagnostic interrupt
		Cause	When operating in "Control" operating mode with soft limits disabled, the traversing range beginning was passed.	
		Effect	The limit switch position is passed by the necessary stopping distance.	
1 (01)	90 – 99 (5A – 63)	System errors		Diagnostic interrupt LED "DIAG" blinking
		Cause	Internal errors in the module	
		Effect	Undefined effects possible	
		Elimination	If this manual is observed, the errors should not occur However, should this still be the case, please consult the responsible sales department. When doing so, it is vitally important to also report the exact circumstances leading to the error.	

Cl. = Detail event class, No. = Detail event number

Note: Value (xx) = Hexadecimal notation of the error number

11.3.2 Error messages

Overview

The errors are listed in Tables 11-6...11-8 according to error class.

Table 11-6 Operator errors

Cl.	No.	Error message, error analysis and remedy	Mes- sage/ Display	
Operator errors		Error response: "Feed STOP" see Table 11-2		
2 (02)	1 (01)	Operating mode not allowed	CBS	
		Cause		The operating mode selected is not allowed.
		Effect		
		Elimination		Select an allowed operating mode
2 (02)	4 (04)	Incorrect operating mode parameters	CBS	
		Cause		In the "Jogging" and "Control" operating modes, the speed or frequency level selected is not 1 or 2. The setpoint number in incremental operating mode is not allowed (1...100 and 254 allowed).
		Effect		
		Elimination		Set operating mode parameters to an allowable value.
2 (02)	5 (05)	Start enable missing	CBS	
		Cause		A travel command was given in the absence of a start enable (start, external start, R+ / R-)
		Effect		
		Elimination		Restore travel command and wait for start enable
2 (02)	9 (09)	Axis is not synchronized	CBS	
		Cause		Synchronization of the axes is necessary in the "Incremental relative", "MDI" and "Automatic" operating modes.
		Effect		
		Elimination		Execute reference point approach
2 (02)	11 (0B)	Direction specification not allowed	CBS	
		Cause		In operating modes "Jog", "Control" or "Incremental relative" the direction settings R+/R- are active at the same time. With "Reference point operation" the direction setting no longer agrees with the startup direction specified in the MD.
		Effect		
		Elimination		Per cause

Cl. = Detail event class, No. = Detail event number, CBS = checkback signals, DB = data block

Note: Value (xx) = Hexadecimal notation of the error number

Table 11-6 Operator errors, continued

Cl.	No.	Error message, error analysis and remedy	Message/ Display	
Operator errors		Error response: "Feed STOP" see Table 11-2		
2 (02)	12 (0C)	Axis movement not possible	CBS	
		Cause		With an unacknowledged error, no drive enable or stop, a traverse command was triggered.
		Effect		
		Elimination		Restore traverse command and switch acknowledge error or Stop to inactive, or give drive enable.
2 (02)	13 (0D)	Incremental value not in place	CBS	
		Cause		The setpoints defined by the operating mode parameters are missing or a change in incremental dimensions occurred when the operating mode started.
		Effect		
		Elimination		Parameterize and read in setpoint parameters
2 (02)	14 (0E)	No program preselected	CBS	
		Cause		No program preselected at "Start."
		Effect		
		Elimination		First preselect program then start.
2 (02)	15 (0F)	Digital input not activated	CBS	
		Cause		The programmed target was reached in a block with external block change (G50).
		Effect		
		Elimination		Check programming (MD34) and connection of digital input.
2 (02)	16 (10)	Measurement function undefined	CBS	
		Cause		Length measurement and inprocess measurement selected simultaneously
		Effect		No measurement function effective.
		Elimination		Reselect one of the two measurement functions.
2 (02)	21 (15)	Activate machine data not allowed	CBS	
		Cause		Processing running is still active (Note Section 7.3.1)
		Effect		Activate machine data not executed
		Elimination		Terminate processing, repeat activate

Cl. = Detail event class, No. = Detail event number, CBS = checkback signals, DB = data block

Note: Value (xx) = Hexadecimal notation of the error number

Table 11-6 Operator errors, continued

Cl.	No.	Error message, error analysis and remedy	Message/ Display
Operator errors		Error response: "Feed STOP" see Table 11-2	
2 (02)	22 (16)	On-the-fly MDI block inoperative	
		Cause	MDI block inactive or already executed
		Effect	On-the-fly MDI block is not being processed
		Elimination	Delete error message and initiate execution as MDI block.
			CBS

Cl. = Detail event class, No. = Detail event number, CBS = checkback signals, DB = data block

Note: Value (xx) = Hexadecimal notation of the error number

Table 11-7 Travel errors

Cl.	No.	Error message, error analysis and remedy	Message/ Display
Travel errors		Error response: "Feed STOP" see Table 11-2	
3 (03)	1 (01)	Software limit switch, beginning	
		Cause	Limit switch approached: in "Jogging" mode, in "Automatic" operating mode if G88/89, without switching signal from the corresponding digital input. The axis is located to the left of the software limit switch because of actual value set.
		Effect	<ul style="list-style-type: none"> Axis movement is stopped at the limit switch position. Set actual value is not executed.
		Elimination	<ul style="list-style-type: none"> Following acknowledgment of the error, it is possible to traverse to the working range. Alter value of software limit switch (MD21) Switch off monitoring limit switch occasionally!  <p>(With the limit switches (MD21/22) disabled, the travel range limits are established by the maximum allowable values for the limit switches).</p>
			CBS

Cl. = Detail event class, No. = Detail event number, CBS = checkback signals, DB = data block

Note: Value (xx) = Hexadecimal notation of the error number

Table 11-7 Travel errors, continued

Cl.	No.	Error message, error analysis and remedy	Message/ Display	
Travel errors		Error response: "Feed STOP" see Table 11-2		
3 (03)	2 (02)	Software limit switch, end	CBS	
		Cause		Limit switch approached: in "Jogging" mode, in "Automatic" operating mode if G88/89, without switching signal from the corresponding digital input. The axis is located to the right of the software limit switch because of actual value set.
		Effect		<ul style="list-style-type: none"> Axis movement is stopped at the limit switch position. Set actual value is not executed.
Elimination	<ul style="list-style-type: none"> Following acknowledgment of the error, it is possible to traverse to the working range. Alter value of software limit switch (MD22) Switch off monitoring limit switch occasionally!  (With the limit switches (MD21/22) disabled, the travel range limits are established by the maximum allowable values for the limit switches). 			
3 (03)	3 (03)	Traversing range beginning approached	CBS	
		Cause		<ul style="list-style-type: none"> During traversing with soft limit switches disabled, the traversing range beginning was approached. The axis is located to the left of the traversing range beginning because of actual value set. (Traversing range: $\pm 10^9$)
		Effect		<ul style="list-style-type: none"> Axis movement is stopped at the traversing range limit. Set actual value is not executed.
Elimination	Travel in the opposite direction			
3 (03)	4 (04)	Traversing range end approached	CBS	
		Cause		<ul style="list-style-type: none"> During traversing with soft limit switches disabled, the traversing range end was approached. The axis is located to the left/right of the traversing range end because of actual value set. (Traversing range: $\pm 10^9$)
		Effect		<ul style="list-style-type: none"> Axis movement is stopped at the traversing range limit. Set actual value is not executed.
Elimination	Travel in the opposite direction			

Cl. = Detail event class, No. = Detail event number, CBS = checkback signals, DB = data block

Note: Value (xx) = Hexadecimal notation of the error number

Table 11-7 Travel errors, continued

Cl.	No.	Error message, error analysis and remedy	Message/Display	
Travel errors		Error response: "Feed STOP" see Table 11-2		
3 (03)	5 (05)	Target position not within traversing range	CBS	
		Cause		<ul style="list-style-type: none"> The position to be approached is outside the working range limited by the software limit switches. The rotary axis programming is specified as a reference value which does not fall within the positive complete circle. With G64 block sequences on rotary axes, a path has been specified further than the traversing range in up to five following blocks.
		Effect		
	Elimination	<ul style="list-style-type: none"> Correct position to be approached. Alter value of software limit switch (MD) With G64 block sequences, program smaller positions in several traversing blocks. Switch off monitoring limit switch occasionally!  (With the limit switches (MD21/22) disabled, the travel range limits are established by the maximum allowable values for the limit switches). 		
3 (03)	23 (17)	Target velocity zero	CBS	
		Cause		<ul style="list-style-type: none"> Zero was entered as programmed velocity. No feed was programmed for positioning.
		Effect		
	Elimination	Input an allowable velocity value		
3 (03)	28 (1C)	M2/M30 missing	CBS	
		Cause		<ul style="list-style-type: none"> In the last program set, block, no M2, M30 or M18 is programmed. The last program set, block is a skip block.
		Effect		Axis movement is prevented.
	Elimination	Per causes		

Cl. = Detail event class, No. = Detail event number, CBS = checkback signals, DB = data block

Note: Value (xx) = Hexadecimal notation of the error number

Table 11-7 Travel errors, continued

Cl.	No.	Error message, error analysis and remedy	Message/ Display	
Travel errors		Error response: "Feed STOP" see Table 11-2		
3 (03)	30 (1E)	Digital input not parameterized	CBS	
		Cause		For the following functions, no necessary digital input is parameterized: <ul style="list-style-type: none"> • Set travel with actual value on the fly (G88, G89) • External block change (G50) • Measurement • Rotation monitoring
		Effect		Functions are not started.
		Elimination		Parameterization of the digital inputs by way of MD34 or MD37
3 (03)	35 (23)	Tool offset value not in place	CBS	
		Cause		No tool offset values are available on the FM 353 or tool offsets are accessed and modified when an override is active.
		Effect		
		Elimination		Parameterize and read in tool offset values
3 (03)	36 (24)	Set actual value on the fly, incorrect value	CBS	
		Cause		Value is no longer within the range $\pm 10^9$
		Effect		
		Elimination		Input a correct value
3 (03)	37 (25)	MDI block on the fly, incorrect syntax	CBS	
		Cause		Incorrect M or G commands or incorrect block structure
		Effect		
		Elimination		Input a correct MDI block
3 (03)	38 (26)	MDI block on the fly, incorrect velocity	CBS	
		Cause		Velocity not within the range between > 0 and max. allowable traverse velocity (500 000 000 MSR/min)
		Effect		
		Elimination		Input a correct MDI block

Cl. = Detail event class, No. = Detail event number, CBS = checkback signals, DB = data block

Note: Value (xx) = Hexadecimal notation of the error number

Table 11-7 Travel errors, continued

Cl.	No.	Error message, error analysis and remedy	Message/ Display	
Travel errors		Error response: "Feed STOP" see Table 11-2		
3 (03)	39 (27)	MDI-block on the fly, incorrect position or dwell time	CBS	
		Cause		Position or dwell time is outside allowable values. Position: $\pm 10^9$ MSR Dwell time: > 100,000 ms
		Effect		
		Elimination		Input a correct MDI block
3 (03)	40 (28)	MDI-block on the fly erroneous	CBS	
		Cause		Incorrect block syntax
		Effect		
		Elimination		Input a correct MDI block
3 (03)	61 (3D)	Servo enable missing	CBS	
		Cause		Traverse command of the axis without servo enable (except for "Control" operating mode)
		Effect		No axis movement
		Elimination		Set servo enable by way of user program
3 (03)	62 (3E)	Servo not ready for operation	CBS	
		Cause		Axis started without Servo ready message
		Effect		No axis movement
		Elimination		<ul style="list-style-type: none"> • Check drive/connecting cables • Analysis of the "Controller ready" message can be disabled by MD37!
3 (03)	66 (42)	Rotation monitoring	CBS	
		Cause		Increment loss, see Section 9.7.3
		Effect		
		Elimination		<ul style="list-style-type: none"> • Check drive • Check MD39, MD51
3 (03)	67 (43)	Boost duration absolute exceeded	CBS	
		Cause		Acceleration phase too long
		Effect		
		Elimination		<ul style="list-style-type: none"> • Check MD48 • Change drive configuration • Change technology (axis traversing cycle)

Cl. = Detail event class, No. = Detail event number, CBS = checkback signals, DB = data block

Note: Value (xx) = Hexadecimal notation of the error number

Table 11-7 Travel errors, continued

Cl.	No.	Error message, error analysis and remedy	Message/ Display	
Travel errors		Error response: "Feed STOP" see Table 11-2		
3 (03)	68 (44)	Boost duration relative exceeded	CBS	
		Cause		Acceleration phases too high in component compared with idle/constant travel
		Effect		
		Elimination		<ul style="list-style-type: none"> • Check MD49 • Change drive configuration • Change technology (axis traversing cycle)

Cl. = Detail event class, No. = Detail event number, CBS = checkback signals, DB = data block

Note: Value (xx) = Hexadecimal notation of the error number

Table 11-8 General data errors, machine data errors, traversing program errors

Cl.	No.	Error message, error analysis and remedy	Message/ Display	
General data errors		Error response: "Warning" see Table 11-2		
4 (04)	1 (01)	Data at time of transmission unacceptable	CBS or DB	
		Cause		Data not transmitted in appropriate operating mode
		Effect		Data not accepted
		Elimination		Transmit data in appropriate operating mode
4 (04)	2 (02)	Velocity level 1 incorrect	CBS or DB	
		Cause		Velocity not within the range between > 0 and max. allowable traverse velocity (500 000 000 MSR/min)
		Effect		Velocity does not become effective
		Elimination		Input an allowed velocity value
4 (04)	3 (03)	Velocity level 2 incorrect	CBS or DB	
		Cause		Velocity not within the range between > 0 and max. allowable traverse velocity (500 000 000 MSR/min)
		Effect		Velocity does not become effective
		Elimination		Input an allowed velocity value

Cl. = Detail event class, No. = Detail event number, CBS = checkback signals, DB = data block

Note: Value (xx) = Hexadecimal notation of the error number

Table 11-8 General data errors, machine data errors, traversing program errors, continued

Cl.	No.	Error message, error analysis and remedy	Message/ Display	
General data errors		Error response: "Warning" see Table 11-2		
4 (04)	4 (04)	Frequency level 1 incorrect	CBS or DB	
		Cause		Specified frequency does fall not within range of 200 kHz or less
		Effect		Frequency level does not become effective
		Elimination		Input an allowed frequency value
4 (04)	5 (05)	Frequency level 2 incorrect	CBS or DB	
		Cause		Specified frequency does fall not within range of 200 kHz or less
		Effect		Frequency level does not become effective
		Elimination		Input an allowed frequency value
4 (04)	6 (06)	Preset incremental value too high	CBS or DB	
		Cause		Incremental value is greater than 10 ⁹ MSR
		Effect		Original incremental value is retained
		Elimination		Input an allowable incremental value
4 (04)	7 (07)	MDI block, incorrect syntax	CBS or DB	
		Cause		Incorrect M or G commands or incorrect block structure
		Effect		Original MDI block is retained
		Elimination		Input a correct MDI block
4 (04)	8 (08)	MDI block, incorrect velocity	CBS or DB	
		Cause		Velocity not within the range between > 0 and max. allowable traverse velocity (500 000 000 MSR/min)
		Effect		Original MDI block is retained
		Elimination		Input a correct MDI block
4 (04)	9 (09)	MDI block, position or dwell time incorrect	CBS or DB	
		Cause		Position or dwell time falls outside the allowable values Position: ± 10 ⁹ MSR Dwell time: > 100,000 ms
		Effect		Original MDI block is retained
		Elimination		Input a correct MDI block
4 (04)	10 (0A)	Zero offset value, offset value incorrect	CBS or DB	
		Cause		Value falls outside the range ± 10 ⁹ MSR
		Effect		Does not become effective
		Elimination		Input a correct value

Cl. = Detail event class, No. = Detail event number, CBS = checkback signals, DB = data block

Note: Value (xx) = Hexadecimal notation of the error number

Table 11-8 General data errors, machine data errors, traversing program errors, continued

Cl.	No.	Error message, error analysis and remedy	Message/ Display	
General data errors		Error response: "Warning" see Table 11-2		
4 (04)	11 (0B)	Set actual value, actual value incorrect	CBS or DB	
		Cause		Actual value falls outside the software limit switches or outside the range $\pm 10^9$ MSR
		Effect		Set actual value does not become effective
		Elimination		Input a correct value
4 (04)	12 (0C)	Set reference point value, reference point incorrect	CBS or DB	
		Cause		Value falls outside the range $\pm 10^9$ MSR
		Effect		Set reference point does not become effective
		Elimination		Input a correct value
4(04)	13 (0D)	Digital output not possible	CBS or DB	
		Cause		Output not available for direct output of the user program
		Effect		Output is not executed
		Elimination		<ul style="list-style-type: none"> • Correct user program • Correct parameterization of the output assignment within the MD35 to the desired assignment
4(04)	14 (0E)	Request application data incorrect	CBS or DB	
		Cause		Incorrect request code
		Effect		Old application data are retained
		Elimination		Request code 0-6, 16-23 and 25 possible
4(04)	15 (0F)	Teach In, program number incorrect	CBS or DB	
		Cause		The program was not parameterized or read in.
		Effect		Teach In is not executed
		Elimination		Parameterize and read in program or correct program number
4(04)	16 (10)	Teach In, block number incorrect	CBS or DB	
		Cause		The block number in the program selected is not in place.
		Effect		Teach In is not executed
		Elimination		Specify correct block number
4(04)	17 (11)	Teach In, dwell time or subprogram request in block	CBS or DB	
		Cause		The block number in the program selected is not in place or incorrect block number was selected.
		Effect		Teach In is not executed
		Elimination		Specify correct block number

Cl. = Detail event class, No. = Detail event number, CBS = checkback signals, DB = data block

Note: Value (xx) = Hexadecimal notation of the error number

Table 11-8 General data errors, machine data errors, traversing program errors, continued

Cl.	No.	Error message, error analysis and remedy	Mes- sage/ Display	
General data errors		Error response: "Warning" see Table 11-2		
4(04)	18 (12)	Teach in, no axis stoppage	CBS or DB	
		Cause		Axis is still in motion
		Effect		Teach In is not executed
		Elimination		Stop axis and repeat task
4(04)	40 (28)	Transmit non-relevant data	CBS or DB	
		Cause		The data (data blocks) transmitted are unknown to the FM 353
		Effect		Data not accepted
		Elimination		Correct user program
4(04)	81 (51) 82 (52) 83 (53) 84 (54) 85 (55)	Programmable modules communication: unauthorized DB type	CBS or DB	
		Programmable modules communication: Info 1 incorrect		
		Programmable modules communication: Info 2 incorrect		
		Programmable modules communication: unauthorized task		
		Programmable modules communication: data errors		
		Cause	Incorrect data	
		Effect	Task is not executed	
		Elimination	Correct and retransmit	
4(04)	120 (78)	Measurement system grid deviates	CBS or DB	
		Cause		The measurement system in the DBs "NC, SM, TO" does not agree with MD7.
		Effect		DB does not become effective and is non-retentively stored
		Elimination		Correct and retransmit
4 (04)	121 (79)	Incorrect DB type in the module	CBS or DB	
		Cause		A incorrect typeis of DB has been transmitted into the FM 353
		Effect		DB does not become effective and is stored non-retentively
		Elimination		Delete DB, correct and retransmit
4 (04)	122 (7A)	DB type or DB no. already exists	CBS or DB	
		Cause		DB type already in place
		Effect		DB does not become effective and is stored non-retentively
		Elimination		Delete corresponding DB prior to transmission

Cl. = Detail event class, No. = Detail event number, CBS = checkback signals, DB = data block

Note: Value (xx) = Hexadecimal notation of the error number

Table 11-8 General data errors, machine data errors, traversing program errors, continued

Cl.	No.	Error message, error analysis and remedy	Message/ Display	
General data errors		Error response: "Warning" see Table 11-2		
4 (04)	123 (7B)	NC program number already exists	CBS or DB	
		Cause		NC program number already exists
		Effect		DB does not become effective and is stored non-retentively
		Elimination		Prior to transmission, delete corresponding DB with the program number
4 (04)	124 (7C)	Parameter "Protect" incorrect	CBS or DB	
		Cause		Coding not 0 or 1
		Effect		DB does not become effective and is stored non-retentively
		Elimination		Coding not 0 or 1
4 (04)	125 (7D)	DB memory filed	CBS or DB	
		Cause		The available memory is assigned
		Effect		DB does not become effective and is stored non-retentively
		Elimination		Delete unnecessary programs (DBs) or compress memory by way of parameterization interface
4 (04)	126 (7E)	Allowable program length exceeded	CBS or DB	
		Cause		Number of blocks too high
		Effect		DB does not become effective and is stored non-retentively
		Elimination		Correct program and retransmit
4 (04)	127 (7F)	Writing parameters/data is not possible	CBS or DB	
		Cause		Axis does not come to a stop
		Effect		Parameters/data do not become effective
		Elimination		Stop axis
4 (04)	128 (80)	Incorrect module identification	CBS or DB	
		Cause		DBs which do not belong to the module were transmitted (no identification 353)
		Effect		DB does not become effective and is not stored modally
		Elimination		Transmit the DBs belonging to the FM 353
4 (04)	129 (81)	Incremental value, incorrect value	CBS or DB	
		Cause		Value range outside $\pm 10^9$
		Effect		Incremental value not effective
		Elimination		Transmit correct value

Cl. = Detail event class, No. = Detail event number, CBS = checkback signals, DB = data block

Note: Value (xx) = Hexadecimal notation of the error number

Table 11-8 General data errors, machine data errors, traversing program errors, continued

Cl.	No.	Error message, error analysis and remedy	Message/ Display	
General data errors		Error response: "Warning" see Table 11-2		
4 (04)	130 (82)	Tool offset, incorrect value		CBS or DB
		Cause	Value range outside $\pm 10^9$	
		Effect	Tool offset not effective	
		Elimination	Transmit correct value	
4 (04)	131 (83)	Not possible to insert block		CBS or DB
		Cause	Memory full	
		Effect	Function is not executed	
Elimination	Delete unnecessary DBs and repeat function			
4 (04)	132 (84)	Not possible to delete block		CBS or DB
		Cause	Block does not exist, no "assignment bits" (bytes 2 and 3) enabled in block (when data available).	
		Effect	Function is not executed	
Elimination	Check program and repeat function with correct block number			
4 (04)	144(90)	SDB cannot be loaded		CBS or DB
		Cause	Module not at standstill	
		Effect	SDB is rejected	
Elimination	Stop module and retry load operation			
4 (04)	145(91)	SDB user data error		CBS or DB
		Cause	SDB contains value error	
		Effect	SDB is rejected	
Elimination	Generate SDB with parameter assignment tool and retry load operation			
Machine data errors		Error response: "Warning" see Table 11-2		
5 (05)	7 (07)	Measurement system		CBS or DB
		Cause	The measurement system grid (MSR) entered does not agree with the MSR in the other DBs of the module.	
		Effect	DB does not become effective and is stored non-retentively	
		Elimination	<ul style="list-style-type: none"> • Check MSR and correct as necessary • When making correct input, delete the other DBs on the module before retransmitting. 	

Cl. = Detail event class, No. = Detail event number, CBS = checkback signals, DB = data block

Note: Value (xx) = Hexadecimal notation of the error number

Table 11-8 General data errors, machine data errors, traversing program errors, continued

Cl.	No.	Error message, error analysis and remedy	Message/ Display	
Machine data errors Error response: "Warning" see Table 11-2				
5 (05)	8 (08)	Type of axis	CBS or DB	
		Cause		No linear or rotary axis parameterized
		Effect		DB does not become effective and is stored non-retentively
		Elimination		Correct and retransmit
5 (05)	9 (09) 11 (0B) 12 (0C) 13(0D) 16 (10)	Rotary axis Travel per motor revolution Residual distance per motor revolution Increments per motor revolution Reference point approach coordinates	CBS or DB	
		Cause		<ul style="list-style-type: none"> • Impermissible value range or • dependency violation on no. 9, 11, 12, 13 (see Section 5.3.1)
		Effect		DB does not become effective and is stored non-retentively
		Elimination		Correct and retransmit
5 (05)	18 (12)	Type of reference point travel	CBS or DB	
		Cause		Unacceptable type of reference point travel
		Effect		DB does not become effective and is stored non-retentively
		Elimination		Correct and retransmit
5 (05)	21 (15) 22 (16) 23 (17) 27 (1B) 28 (1C) 29 (1D) 30 (1E)	Software limit switch, begin Software limit switch, end Maximum velocity Reference point offset Referencing velocity Reducing velocity Backlash compensation	CBS or DB	
		Cause		<ul style="list-style-type: none"> • Impermissible value range or • dependency violation on no. 21, 22, 28, 29 (see Section 5.3.1)
		Effect		DB does not become effective and is stored non-retentively
		Elimination		Correct and retransmit
5 (05)	31 (1F)	Backlash vector reference	CBS or DB	
		Cause		Backlash vector reference undefined
		Effect		DB does not become effective and is stored non-retentively
		Elimination		Correct and retransmit

Cl. = Detail event class, No. = Detail event number, CBS = checkback signals, DB = data block

Note: Value (xx) = Hexadecimal notation of the error number

Table 11-8 General data errors, machine data errors, traversing program errors, continued

Cl.	No.	Error message, error analysis and remedy	Mes- sage/ Display	
Machine data errors				
Error response: "Warning" see Table 11-2				
5 (05)	32 (20)	Type of output, M-function	CBS or DB	
		Cause		Type of output, M-function not defined
		Effect		DB does not become effective and is stored non-retentively
		Elimination		Correct and retransmit
5 (05)	33 (21)	Output time, M-function	CBS or DB	
		Cause		Unacceptable value range
		Effect		DB does not become effective and is stored non-retentively
		Elimination		Correct and retransmit
5 (05)	34 (22)	Digital inputs	CBS or DB	
		Cause		Inputs undefined or defined more than once
		Effect		DB does not become effective and is stored non-retentively
		Elimination		Correct and retransmit
5 (05)	35 (23)	Digital outputs	CBS or DB	
		Cause		Outputs undefined or defined more than once
		Effect		DB does not become effective and is stored non-retentively
		Elimination		Correct and retransmit
5 (05)	36 (24)	Input adapter	CBS or DB	
		Cause		Input adapter undefined
		Effect		DB does not become effective and is stored non-retentively
		Elimination		Correct and retransmit
5 (05)	52 (34) 53 (35)	Velocity for backlash compensation Backlash compensation mode	CBS or DB	
		Cause		Impermissible value range or dependency violation (see Section 5.3.1).
		Effect		DB does not become effective and is stored non-retentively.
		Elimination		Correct and retransmit.
5 (05)	67(43) 68 (44)	Special control signals Number of increments per current-sourcing cycle	CBS or DB	
		Cause		Impermissible value range or dependency violation on no. 68 (see Section 5.3.1)
		Effect		DB does not become effective and is stored non-retentively
		Elimination		Correct and retransmit

Cl. = Detail event class, No. = Detail event number, CBS = checkback signals, DB = data block

Note: Value (xx) = Hexadecimal notation of the error number

Table 11-8 General data errors, machine data errors, traversing program errors, continued

Cl.	No.	Error message, error analysis and remedy	Message/ Display	
Machine data errors		Error response: "Warning" see Table 11-2		
5 (05)	69(45) 70 (46) 71 (47) 72 (48) 73 (49) 74 (4A) 75 (4B)	Start/Stop frequency Frequency value for acceleration switchover Maximum frequency Acceleration 1 Acceleration 2 Delay 1 Delay 2	CBS or DB	
		Cause		<ul style="list-style-type: none"> Impermissible value range, see "Working range, frequency generator" or dependency violation on no. 70...75 (see Section 5.3.1)
		Effect		DB does not become effective and is stored non-retentively
		Elimination		Correct and retransmit
5 (05)	76(4C) 77(4D) 78(4E) 79(4F) 80(50) 81(51)	Minimum stoppage time between two positioning operations minimum traversing time at constant frequency Boost duration absolute Boost duration relative Phase current traversing Phase current zero speed	CBS or DB	
		Cause		Unacceptable value range
		Effect		DB does not become effective and is stored non-retentively
		Elimination		Correct and retransmit
5 (05)	96 (60)	Software limit unacceptable	CBS or DB	
		Cause		With linear axes: Software begin limit switch greater than software limit switch end with rotary axes: Software begin/end limit switches not within rotary axis cycle and not at maximum input value.
		Effect		DB does not become effective and is stored non-retentively
		Elimination		Correct and retransmit
5 (05)	99 (63)	Impermissible actual value evaluation factor	CBS or DB	
		Cause		Impermissible relationship in the assignments for distance per motor revolution (MD11, 12) and increments per motor revolution (MD13) (see Section 5.3.1).
		Effect		DB does not become effective and is stored non-retentively.
		Elimination		Correct and retransmit.

Cl. = Detail event class, No. = Detail event number, CBS = checkback signals, DB = data block

Note: Value (xx) = Hexadecimal notation of the error number

Table 11-8 General data errors, machine data errors, traversing program errors, continued

Cl.	No.	Error message, error analysis and remedy	Message/Display	
Machine data errors Error response: "Warning" see Table 11-2				
5 (05)	102 (66)	Limitation, software limit for linear axis	CBS or DB	
		Cause		For step resolutions < 1 MSR, the permissible traversing range in the ratio of MSR to increments is limited (e.g. for 0.5 µm per step to 0.5 · 10 ⁹ MSR) (see Section 5.3.1).
		Effect		DB does not become effective and is stored non-retentively.
		Elimination		Correct and retransmit.
Traversing program errors Error response: "Warning" see Table 11-2				
8 (08)	1 (01)	Program selection, subprogram number incorrect	CBS or DB	
		Cause		<ul style="list-style-type: none"> The subroutine requested in the program is not in place on the FM 353. The subprogram called in the program contains another subprogram call. Nesting is not possible.
		Effect		Program selection is not executed
		Elimination		<ul style="list-style-type: none"> Parameterize and read in program, correct as necessary Select another program
8 (08)	8 (08)	Program selection, program number not in place	CBS or DB	
		Cause		The program was not parameterized, not in place on the FM 353.
		Effect		Program selection is not executed
		Elimination		<ul style="list-style-type: none"> Parameterize and read in program, correct as necessary Select another program
8 (08)	9 (09)	Program selection, block number not in place	CBS or DB	
		Cause		The block number is missing in the program selected
		Effect		Program selection is not executed
		Elimination		<ul style="list-style-type: none"> Correct program Select different block number
8 (08)	10 (0A)	Program, block number unacceptable	CBS or DB	
		Cause		Block number missing or outside of the number range
		Effect		Program is not stored
		Elimination		Correct program

Cl. = Detail event class, No. = Detail event number, CBS = checkback signals, DB = data block

Note: Value (xx) = Hexadecimal notation of the error number

Table 11-8 General data errors, machine data errors, traversing program errors, continued

Cl.	No.	Error message, error analysis and remedy	Mes- sage/ Display	
Traversing program errors Error response: "Warning" see Table 11-2				
8 (08)	11 (0B)	Program selection, direction specification incorrect	CBS or DB	
		Cause		Direction specification incorrect
		Effect		Program selection is not executed
		Elimination		Correct program selection and repeat.
8 (08)	12 (0C)	Program selection unacceptable	CBS or DB	
		Cause		Another program was preselected during a movement
		Effect		Program selection is not executed
		Elimination		Use STOP to stop program in progress, or repeat program selection at end of program.
8 (08)	20 (14)	Error, program number	CBS or DB	
		Cause		Program numbers in the blocks incorrect
		Effect		Program is not stored
		Elimination		Correct program, per cause
8 (08)	21 (15)	No block in program	CBS or DB	
		Cause		No block in program
		Effect		Program is not stored
		Elimination		Correct program, per cause
8 (08)	22 (16)	Error, block number	CBS or DB	
		Cause		Block number value range incorrect
		Effect		Program is not stored
		Elimination		Correct program
8 (08)	23 (17)	Block number sequence incorrect	CBS or DB	
		Cause		Block number not in ascending order
		Effect		Program is not stored
		Elimination		Correct program
8 (08)	24 (18)	G function 1 unacceptable	CBS or DB	
		Cause		<ul style="list-style-type: none"> • The number programmed as G function 1 is not allowed. • In block, other data besides M functions were programmed with dwell time (G04).
		Effect		Program/block not stored
		Elimination		Correct program, per cause

Cl. = Detail event class, No. = Detail event number, CBS = checkback signals, DB = data block

Note: Value (xx) = Hexadecimal notation of the error number

Table 11-8 General data errors, machine data errors, traversing program errors, continued

Cl.	No.	Error message, error analysis and remedy	Message/Display	
Traversing program errors Error response: "Warning" see Table 11-2				
8 (08)	25 (19)	G function 2 unacceptable	CBS or DB	
		Cause		The number programmed as G function 2 is not allowed.
		Effect		Program/block not stored
		Elimination		Correct program, per cause
8 (08)	26 (1A)	G function 3 unacceptable	CBS or DB	
		Cause		<ul style="list-style-type: none"> The number programmed as G function 3 is not allowed. External block change (G50) was programmed in a block together with continuous operation for setting actual value on the fly (G88/89). A tool offset (G43, G44) was called up without D number. In selecting a D number, the direction specification is missing for the tool offset (G43, G44).
		Effect		Program/block not stored
		Elimination		Correct program, per cause
8 (08)	27 (1B)	M-function unacceptable	CBS or DB	
		Cause		<ul style="list-style-type: none"> The number programmed as M-function is not allowed. At least two of the M functions M0, M2, M18, M30, which cancel each other out, are found in one block.
		Effect		Program/block not stored
		Elimination		Correct program, per cause
8 (08)	28 (1C)	Position/dwell time missing	CBS or DB	
		Cause		<ul style="list-style-type: none"> No dwell time specified in block with G04. Target position missing with external block change (G50). No new actual value programmed for the function continuous operation with setting actual value on the fly (G88/89).
		Effect		Program/block not stored
		Elimination		Correct program, per cause
8 (08)	29 (1D)	Incorrect D-NO (>20)	CBS or DB	
		Cause		The number for tool offset is greater than 20
		Effect		Program/block not stored
		Elimin.		Correct program, per cause

Cl. = Detail event class, No. = Detail event number, CBS = checkback signals, DB = data block

Note: Value (xx) = Hexadecimal notation of the error number

Table 11-8 General data errors, machine data errors, traversing program errors, continued

Cl.	No.	Error message, error analysis and remedy	Message/ Display	
Traversing program errors Error response: "Warning" see Table 11-2				
8 (08)	30 (1E)	Error, subroutine	CBS or DB	
		Cause		Subroutine without number of runs
		Effect		Program is not stored
		Elimination		Correct program, per cause
8 (08)	31 (1F)	Velocity missing	CBS or DB	
		Cause		No velocity was programmed
		Effect		Program/block not stored
		Elimination		Correct program, per cause
8 (08)	32 (20)	Error, callup subroutine	CBS or DB	
		Cause		Block syntax for callup subroutine is incorrect
		Effect		Program is not stored
		Elimination		Correct program, per cause
8 (08)	33 (21)	D function unacceptable	CBS or DB	
		Cause		Block syntax for invoking a D function is incorrect
		Effect		Program is not stored
		Elimination		Correct program, per cause
8 (08)	34 (22)	Incorrect program length	CBS or DB	
		Cause		Maximum block number exceeded
		Effect		Program is not stored
		Elimination		Correct program, per cause

Cl. = Detail event class, No. = Detail event number, CBS = checkback signals, DB = data block

Note: Value (xx) = Hexadecimal notation of the error number



Technical Specifications

A

Overview

This chapter describes the technical data for the FM 353 positioning module.

- General technical data
- Dimensions and weight
- Load memory
- Drive port
- Digital inputs
- Digital outputs

General technical data

General technical data include:

- Electromagnetic compatibility
- Shipping and storage conditions
- Ambient mechanical and climate conditions
- Data on insulation testing, protection class and degree of protection

This information contains standards and test values incorporated into the S7-300 with which it is also in compliance with, or according to whose criteria the S7-300 was tested.

The general technical data are described in the manual “Installing an S7-300.”

UL/CSA certifications

The following certifications are on record for the FM 353:

UL Recognition Mark

Underwriters Laboratories (UL) in compliance with
UL Standard 508, File E 164110

CSA Certification Mark

Canadian Standard Association (CSA) in compliance with
Standard C 22.2 No. 142

FM approval

The FM approval is on record for the FM 353:
FM certification in accordance with Factory Mutual Approval Standard Class Number 3611, Class I, Division 2, Group A, B, C, D.



Warning

Potential for personal injury and property damage.

In areas where there is a risk of explosion, personal injury and property damage may occur if you disconnect plugs while the S7-300 is in operation.

In areas where there is a risk of explosion, always cut off power to the S7-300 before disconnecting plugs.



Warning

WARNING - NEVER DISCONNECT WHILE CIRCUIT IS LIVE
UNLESS LOCATION IS KNOWN TO BE NONHAZARDOUS

CE marking

Our products are in compliance with the EU Guideline 89/336/EEC “Electromagnetic Compatibility” and the harmonized European standards (EN) which it embodies.



The EC Declaration of Conformity in accordance with Article 10 of the EU Guideline referenced above can be found on the Internet at:

<http://support.automation.siemens.com/WW/view/de/15257461>

Application

SIMATIC products are designed for application in an industrial environment.

Application	Requirement concerning	
	Noise emission	Noise immunity
Industry	EN 50081-2 : 1993	EN 61000-6-2 : 1999

Observe installation guidelines

SIMATIC products meet the requirements, provided you observe the installation guidelines set forth in the manuals during installation and operation.

Connected load

Technical data: Connected load

Table A-1 Connected load

Supply voltage	20.4 – 28.8 V
Power consumption from 24 V	0.3 A
Power loss	7 W
Startup current	2.1 A
Power consumption from 5 V back-plane bus	100 mA

Dimensions and weights

Technical data for dimensions and weights:

Table A-2 Technical data: dimensions and weight

Dimensions W × H × D [mm/in]	80 × 125 × 118
Weight [g/lb]	approx. 550 / 1 lb, 3.3 oz

Memory for parameter data

RAM memory 16 Kbytes

FEPRM for retentive storage of parameter data

FM cycle

2 ms

Drive port

Technical data on drive port:

Table A-3 Technical data: on drive port

Signal voltage	5 V, RS422-compliant
Max. pulse frequency	200 kHz

Digital inputs

Technical data for digital inputs:

Table A-4 Technical data: digital inputs

Number of inputs	5 (including controller ready)
Supply voltage	24 V DC (allowable range: 20.4 – 28.8 V)
Electrical isolation	No
Input voltage	<ul style="list-style-type: none"> 0 signal: –3 – 5 V 1 signal: 11 – 30 V
Input current	<ul style="list-style-type: none"> 0 signal: ≤ 2 mA 1 signal: 6 – 15 mA
Input delay (DE1 – 4)	<ul style="list-style-type: none"> 0 → 1 signal: type 15 μs 1 → 0 signal: type 150 μs
Connecting a 2-conductor sensor	Possible

Digital outputs

Technical data for digital outputs:

Table A-5 Technical data: digital outputs

Number of outputs	4
Supply voltage	24 V DC (allowable range: 20.4 – 28.8 V)
Electrical isolation	No
Output voltage	<ul style="list-style-type: none"> 0 signal: Residual current max. 2 mA 1 signal: (Power supply –3 V)
Output current on signal “1”	<ul style="list-style-type: none"> at ambient temperature of 40°C <ul style="list-style-type: none"> Rated value: 0.5 A (total current 2 A) Permissible value range: 5 mA...0.6 A (over power supply range) Lamp load: max. 5 W at ambient temperature of 60°C <ul style="list-style-type: none"> Rated value: 0.1 A (total current 0.4 A) Permissible value range: 5 mA...0.12 A (over power supply)
Output delay	<ul style="list-style-type: none"> 0 → 1 signal: type 300 μs 1 → 0 signal: type 300 μs
Short circuit	Yes
Switching rate	<ul style="list-style-type: none"> Resistive load: max. 100 Hz Inductive load: max. 0.25 Hz



B

User Data Block (AW-DB)

Table B-1 User data block (AW-DB)

Adresse absolut	Variable	Data type	Comment
General addresses			
0	MOD_ADR	INT	Module address
2...13.5			Reserved
13.6	MODE_BUSY	BOOL	Execution started
13.7	POS_REACHED	BOOL	Position
Control signals			
14.0			Reserved
14.1	TEST_EN	BOOL	Switch to P bus Start-up
14.2			Reserved
14.3	OT_ERR_A	BOOL	Acknowledge operator/traversing error
14.4...14.7			Reserved
15.0	START	BOOL	Start
15.1	STOP	BOOL	Stop
15.2	DIR_M	BOOL	Negative direction
15.3	DIR_P	BOOL	Positive direction
15.4	ACK_MF	BOOL	Acknowledge M function
15.5	READ_EN	BOOL	Read-in enable
15.6	SKIP_BLK	BOOL	Block skip
15.7	DRV_EN	BOOL	Drive enable
16	MODE_IN	BYTE	Operating mode
17	MODE_TYPE	BYTE	Operating mode parameters
18	OVERRIDE	BYTE	Override
19...21			Reserved
Checkback signals			
22.0			Reserved
22.1	TST_STAT	BOOL	Switch to P bus completed
22.2			Reserved
22.3	OT_ERR	BOOL	Operator/traversing error

Table B-1 User data block (AW-DB), continued

Adresse absolut	Variable	Data type	Comment
22.4	DATA_ERR	BOOL	Data error
22.5...22.6			Reserved
22.7	PARA	BOOL	Channel parameterizell
23.0	ST_ENBLD	BOOL	Start enable
23.1	WORKING	BOOL	Machining in progress
23.2	WAIT_EI	BOOL	Wait for external enable
23.3...23.4			Reserved
23.5	DT_RUN	BOOL	Dwell in progress
23.6	PR_BACK	BOOL	Reverse prog. scan
23.7			Reserved
24	MODE_OUT	BYTE	Active operating mode
25.0	SYNC	BOOL	Channel synchronized
25.1	MSR_DONE	BOOL	End of measurement
25.2	GO_M	BOOL	Negative travel
25.3	GO_P	BOOL	Positive travel
25.4	ST_SERVO	BOOL	Servo enable status
25.5	FVAL_DONE	BOOL	On-the-fly setting of actual value completed
25.6			Reserved
25.7	POS_RCD	BOOL	Position reached. Stop.
26	NUM_MF	BYTE	M function number
27.0...27.3			Reserved
27.4	STR_MF	BOOL	M function strobe signal
27.5...33			Reserved
28...31	ACT_POS	DINT	Actual position
32...33			Reserved
Initiation signals for single settings			
34.0	SERVO_EN	BOOL	Controller enable
34.1	GAUG_FLY	BOOL	On-the-fly measuring
34.2...34.4			Reserved
34.5	TRAV_MON	BOOL	Rotation monitoring
34.6	PARK_AX	BOOL	Parking axis
34.7	SIM_ON	BOOL	Simulation on
35.0...35.1			Reserved
35.2	MSR_EN	BOOL	Length measurement
35.3	REF_TRIG	BOOL	Retrigger reference point
35.4	DI_OFF	BOOL	Enable input disabled

Table B-1 User data block (AW-DB), continued

Adresse absolut	Variable	Data type	Comment
35.5			Reserved
35.6	SSW_DIS	BOOL	Software limit positions disabled
35.7			Reserved
Initiation signals for single commands			
36			Reserved
37.0	MD_EN	BOOL	Activate MD
37.1	DELDIST_EN	BOOL	Delete residual distance
37.2	SEARCH_F	BOOL	Automatic block advance
37.3	SEARCH_B	BOOL	Automatic block return
37.4			Reserved
37.5	RESET_AX	BOOL	Restart
37.6	AVALREM_EN	BOOL	Rescind setting of actual value
37.7			Reserved
Initiation signals for Write requests			
38.0	VLEV_EN	BOOL	Speed levels 1, 2
38.1	CLEV_EN	BOOL	Frequency levels 1, 2
38.2	TRG254_EN	BOOL	Setpoint for incremental dimension
38.3	MDI_EN	BOOL	MDI block
38.4	MDIFLY_EN	BOOL	On-the-fly MDI block
38.5			Reserved
38.6	REFPT_EN	BOOL	Set reference point
38.7	AVAL_EN	BOOL	Set actual value
39.0	FVAL_EN	BOOL	On-the-fly setting of actual value
39.1	ZOFF_EN	BOOL	Zero offset
39.2			Reserved
39.3	PARCH_EN	BOOL	Modify parameters/data
39.4	DIGO_EN	BOOL	Digital outputs
39.5	PROGS_EN	BOOL	Program selection
39.6	REQAPP_EN	BOOL	Request application data
39.7	TEACHIN_EN	BOOL	Teach-in
40...41			Reserved
Initiation signals for Read requests			
42.0	OPDAT_EN	BOOL	Basic operating data
42.1	ACT_BL_EN	BOOL	Active NC block
42.2	NXT_BL_EN	BOOL	Next NC block

Table B-1 User data block (AW-DB), continued

Adresse absolut	Variable	Data type	Comment
42.3	BLEXT_EN	BOOL	Actual value block change
42.4	SERVDAT_EN	BOOL	Service data
42.5	OC_ERR_EN	BOOL	Operating error no.
42.6...43.2			Reserved
43.3	PARRD_EN	BOOL	Parameter/data
43.4	DIGIO_EN	BOOL	Dig. inputs/outputs
43.5	OPDAT1_EN	BOOL	Additional operating data
43.6	APPDAT_EN	BOOL	Application data
43.7	MSRRD_EN	BOOL	Read measured values
Ready signals (for Initiation signals, single settings)			
44.0	SERVO_D	BOOL	Controller enable
44.1	GAUG_FLY_D	BOOL	On-the-fly measuring
44.2...44.4			Reserved
44.5	TRAV_MON_D	BOOL	Rotation monitoring
44.6	PARK_AX_D	BOOL	Parking axis
44.7	SIM_ON_D	BOOL	Simulation on
45.0...45.1			Reserved
45.2	MSR_D	BOOL	Length measurement
45.3	REF_TRIG_D	BOOL	Retrigger reference point
45.4	DI_OFF_D	BOOL	Enable input disabled
45.5			Reserved
45.6	SSW_DIS_D	BOOL	Software limit positions disabled
45.7			Reserved
Ready signals (for Initiation signals, single commands)			
46			Reserved
47.0	MD_D	BOOL	Activate MD
47.1	DELDIST_D	BOOL	Delete residual distance
47.2	SEARCH_F_D	BOOL	Automatic block advance
47.3	SEARCH_B_D	BOOL	Automatic block return
47.4			Reserved
47.5	RESET_AX_D	BOOL	Restart
47.6	AVALREM_D	BOOL	Rescind setting of actual value
47.7			Reserved
Ready signals (for Initiation signals for Write requests)			
48.0	VLEV_D	BOOL	Speed levels 1, 2

Table B-1 User data block (AW-DB), continued

Adresse absolut	Variable	Data type	Comment
48.1	CLEV_D	BOOL	Frequency levels 1, 2
48.2	TRG254_D	BOOL	Setpoint for incremental dimension
48.3	MDI_D	BOOL	MDI block
48.4	MDIFLY_D	BOOL	On-the-fly MDI block
48.5			Reserved
48.6	REFPT_D	BOOL	Set reference point
48.7	AVAL_D	BOOL	Set actual value
49.0	FVAL_D	BOOL	On-the-fly setting of actual value
49.1	ZOFF_D	BOOL	Zero offset
49.2			Reserved
49.3	PARCH_D	BOOL	Modify parameters/data
49.4	DIGO_D	BOOL	Digital outputs
49.5	PROGS_D	BOOL	Program selection
49.6	REQAPP_D	BOOL	Request application data
49.7	TEACHIN_D	BOOL	Teach-in
50...51			Reserved
Ready signals (for Initiation signals for Read requests)			
52.0	OPDAT_D	BOOL	Basic operating data
52.1	ACT_BL_D	BOOL	Active NC block
52.2	NXT_BL_D	BOOL	Next NC block
52.3	BLEXT_D	BOOL	Actual value block change
52.4	SERVDAT_D	BOOL	Service data
52.5	OC_ERR_D	BOOL	Operating error read
52.6	OT_ERR_D	BOOL	Operator/traversing error read
52.7	DA_ERR_D	BOOL	Data error read
53.0...53.2			Reserved
53.3	PARRD_D	BOOL	Parameter/data
53.4	DIGIO_D	BOOL	Dig. inputs/outputs
53.5	OPDAT1_D	BOOL	Additional operating data
53.6	APPDAT_D	BOOL	Application data
53.7	MSRRD_D	BOOL	Read measured values
Error signals (for Initiation signals, single settings)			
54.0	SERVO_ERR	BOOL	Controller enable
54.1	GAUG_FLY_ERR	BOOL	On-the-fly measuring
54.2...54.4			Reserved

Table B-1 User data block (AW-DB), continued

Adresse absolut	Variable	Data type	Comment
54.5	TRAV_MON_ERR	BOOL	Rotation monitoring
54.6	PARK_AX_ERR	BOOL	Parking axis
54.7	SIM_ON_ERR	BOOL	Simulation on
55.0...55.1			Reserved
55.2	MSR_ERR	BOOL	Length measurement
55.3	REF_TRIG_ERR	BOOL	Retrigger reference point
55.4	DI_OFF_ERR	BOOL	Enable input disabled
55.5			Reserved
55.6	SSW_DIS_ERR	BOOL	Software limit positions disabled
55.7			Reserved
Error signals (for Initiation signals, single commands)			
56			Reserved
57.0	MD_ERR	BOOL	Activate MD
57.1	DELDIST_ERR	BOOL	Delete residual distance
57.2	SEARCH_F_ERR	BOOL	Automatic block advance
57.3	SEARCH_B_ERR	BOOL	Automatic block return
57.4			Reserved
57.5	RESET_AX_ERR	BOOL	Restart
57.6	AVALREM_ERR	BOOL	Rescind setting of actual value
57.7			Reserved
Error signals (for Initiation signals for Write requests)			
58.0	VLEV_ERR	BOOL	Speed levels 1, 2
58.1	CLEV_ERR	BOOL	Frequency levels 1, 2
58.2	TRG254_ERR	BOOL	Setpoint for incremental dimension
58.3	MDI_ERR	BOOL	MDI block
58.4	MDIFLY_ERR	BOOL	On-the-fly MDI block
58.5			Reserved
58.6	REFPT_ERR	BOOL	Set reference point
58.7	AVAL_ERR	BOOL	Set actual value
59.0	FVAL_ERR	BOOL	On-the-fly setting of actual value
59.1	ZOFF_ERR	BOOL	Zero offset
59.2			Reserved
59.3	PARCH_ERR	BOOL	Modify parameters/data
59.4	DIGO_ERR	BOOL	Digital outputs
59.5	PROGS_ERR	BOOL	Program selection

Table B-1 User data block (AW-DB), continued

Adresse absolut	Variable	Data type	Comment
59.6	REQAPP_ERR	BOOL	Request application data
59.7	TEACHIN_ERR	BOOL	Teach-in
60...61			Reserved
Error signals (for Initiation signals for Read requests)			
62.0	OPDAT_ERR	BOOL	Basic operating data
62.1	ACT_BL_ERR	BOOL	Active NC block
62.2	NXT_BL_ERR	BOOL	Next NC block
62.3	BLEXT_ERR	BOOL	Actual value block change
62.4	SERVDAT_ERR	BOOL	Service data
62.5	OC_ERR_ERR	BOOL	Operating error read
62.6	OT_ERR_ERR	BOOL	Operator/traversing error read
62.7	DA_ERR_ERR	BOOL	Data error read
63.0...63.2			Reserved
63.3	PARRD_ERR	BOOL	Parameter/data
63.4	DIGIO_ERR	BOOL	Dig. inputs/outputs
63.5	OPDAT1_ERR	BOOL	Additional operating data
63.6	APPDAT_ERR	BOOL	Application data
63.7	MSRRD_ERR	BOOL	Read measured values
64...65			Reserved
Error messages/status signals from POS_CTRL			
66	JOB_ERR	INT	Error code SFC 58/59 (POS_CTRL)
68.0	JOBBUSY_WR	BOOL	Write job active
68.1	IMPO_WR	BOOL	Write request not possible
68.2	JOBBUSY_RD	BOOL	Read job active
68.3	IMPO_RD	BOOL	Read request not possible
68.4...69.0			Reserved
69.1	JOBRESET	BOOL	Reset status/error
69.2...69.7			Reserved
Diagnostic interrupt data (POS_DIAG)			
70.0	MDL_DEFECT	BOOL	Module/group errors (coming and going)
70.1	INT_FAULT	BOOL	Internal error/hardware error (group error DBB72, 73)
70.2	EXT_FAULT	BOOL	External error
70.3	PNT_INFO	BOOL	External channel error (group error bytes 78)
70.4...70.5			Reserved
70.6	NO_CONFIG	BOOL	Module not initialized

Table B-1 User data block (AW-DB), continued

Adresse absolut	Variable	Data type	Comment
70.7			Reserved
71	MDL_TYPE	BYTE	Module type class for FM 453 = 08H / Channel information available
72.0			Reserved
72.1	COMM_FAULT	BOOL	Communication error (K bus)
72.2			Reserved
72.3	WTCH_DOG_FLT	BOOL	Response from watchdog timer
72.4	INT_PS_FLT	BOOL	Internal supply voltage to the module failed (NMI)
72.5...73.1			Reserved
73.2	EPROM_FLT	BOOL	FEEPROM error
73.3	RAM_FLT	BOOL	RAM error
73.4...73.5			Reserved
73.6	HW_INTR_FLT	BOOL	Process interrupt lost
73.7			Reserved
74	POS_ID	BYTE	FM pos. ID (74H)
75	LEN_INFO	BYTE	Length of the diagnostic information (16)
76	CHEN_NO	BYTE	Number of channels (1)
77.0	CH_ERR_VE1	BOOL	Channel error vector
77.1...78.6			Reserved
78.7	OC_ERR_EN1	BOOL	Operating error for channel
79..85			Reserved
86	OC_ERR_NO	BYTE	Error number (DS 164) – Detail event class
87	OC_REE_CL	BYTE	Error number (DS 164) – Detail event number
88...89			Reserved
90	OT_ERR_NO	BYTE	Error number (DS 162) – Detail event class
91	OT_ERR_CL	BYTE	Error number (DS 162) – Detail event number
92...93			Reserved
94	DA_ERR_NO	BYTE	Error number (DS163) – Detail event class
95	DA_ERR_CL	BYTE	Error number (DS163) – Detail event number
96	DIAG_ERR	INT	Error code for POS_DIAG (return code SFC 51)
98	MSRM_ERR	INT	Error code for POS_MSRM (return code SFC 59/SFB42)
100		ARRAY [100 ..139] BYTE	Internal, Reserved

Table B-1 User data block (AW-DB), continued

Adresse absolut	Variable	Data type	Comment
Data for the requests			
140	ZOFF	DINT	Zero offset
144	AVAL	DINT	Set actual value
148	FVAL	DINT	On-the-fly setting of actual value
152	REFPT	DINT	Set reference point
156	TRG254	DWORD	Setpoint for incremental dimension
160	VLEVEL_1	DWORD	Speed level 1
164	VLEVEL_2	DWORD	Speed level 2
168	CLEVEL_1	DWORD	Frequency level 1
172	CLEVEL_2	DWORD	Frequency level 2
MDI block			
176	MDIB	STRUCT	MDI block
+ 0...+1			Reserved
+ 2.0	G_1_EN	BOOL	G function group 1
+ 2.1	G_2_EN	BOOL	G function group 2
+ 2.2...+ 2.3			Reserved
+ 2.4	X_T_EN	BOOL	Position/ dwell
+ 2.5...+ 2.7			Reserved
+ 3.0	V_EN	BOOL	Speed
+ 3.1	M_1_EN	BOOL	M function group 1
+ 3.2	M_2_EN	BOOL	M function group 2
+ 3.3	M_3_EN	BOOL	M function group 3
+ 3.4...+ 3.7			Reserved
+ 4	G_1_VAL	BYTE	G function no. of group 1
+ 5	G_2_VAL	BYTE	G function no. of group 2
+ 6...+ 7			Reserved
+ 8	X_T_VAL	DINT	Value for position/dwell
+ 12	V_VAL	DINT	Value for speed
+ 16	M_1_VAL	BYTE	M function no. of group 1
+ 17	M_2_VAL	BYTE	M function no. of group 2
+ 18	M_3_VAL	BYTE	M function no. of group 3
+ 19			Reserved
		END_STRUCT	
Modify parameter/data			
196	PAR_CHAN	STRUCT	Modify parameter/data

Table B-1 User data block (AW-DB), continued

Adresse absolut	Variable	Data type	Comment
+ 0	TYP	BYTE	DB type
+ 1	NUMB	BYTE	Number
+ 2	COUN	BYTE	Quantity
+ 3	JOB	BYTE	Request
+ 4	DATA	ARRAY [200 ..219] BYTE	Data array, structure/data type of Write data as per bytes 1 to 4 of this structure
		END_STRUCT	
Digital inputs/outputs (for read and write)			
220.0	D_IN0	BOOL	Digital input 0
220.1	D_IN1	BOOL	Digital input 1
220.2	D_IN2	BOOL	Digital input 2
220.3	D_IN3	BOOL	Digital input 3
220.4...7			Reserved
221.0	D_OUT0	BOOL	Digital output 0
221.1	D_OUT1	BOOL	Digital output 1
221.2	D_OUT2	BOOL	Digital output 2
221.3	D_OUT3	BOOL	Digital output 3
221.4...7			Reserved
On-the-fly MDI block			
222	MDI_F	STRUCT	On-the-fly MDI block
+ 0...+ 1			Reserved
+ 2.0	G_1_EN	BOOL	G function group 1
+ 2.1	G_2_EN	BOOL	G function group 2
+ 2.2...+ 2.3			Reserved
+ 2.4	X_T_EN	BOOL	Position/dwell
+ 2.5...+ 2.7			Reserved
+ 3.0	V_EN	BOOL	Speed
+ 3.1	M_1_EN	BOOL	M function group 1
+ 3.2	M_2_EN	BOOL	M function group 2
+ 3.3	M_3_EN	BOOL	M function group 3
+ 3.4...+ 3.7			Reserved
+ 4	G_1_VAL	BYTE	G function no. of group 1
+ 5	G_2_VAL	BYTE	G function no. of group 2
+ 6...+ 7			Reserved
+ 8	X_T_VAL	DINT	Value for position/dwell

Table B-1 User data block (AW-DB), continued

Adresse absolut	Variable	Data type	Comment
+ 12	V_VAL	DINT	Value for speed
+ 16	M_1_VAL	BYTE	M function no. of group 1
+ 17	M_2_VAL	BYTE	M function no. of group 2
+ 18	M_3_VAL	BYTE	M function no. of group 3
+ 19			Reserved
		END_STRUCT	
Program selection			
242	PROG_NO	BYTE	Program number
243	BLCK_NO	BYTE	Block number
244	PROG_DIR	BYTE	Direction of processing
245			Reserved
Request for application data			
246	CODE_AP1	BYTE	Application data 1
247	CODE_AP2	BYTE	Application data 2
248	CODE_AP3	BYTE	Application data 3
249	CODE_AP4	BYTE	Application data 4
Teach-in			
250	TEA_PROG_NO	BYTE	Program number
251	TEA_BLCK_NO	BYTE	Block number
252	FELD2_INTERN	ARRAY [252...309] BYTE	Internal, Reserved
Basic operating data			
310	ACT_VAL	DINT	Actual position
314	SPEED	DWORD	Actual speed
318	REM_DIST	DINT	Residual distance
322	SET_POS	DINT	Setpoint position
326	SUM_OFST	DINT	Sum of active coordinate offset, tool offset, zero offset
330	TRAV_SPE	DWORD	Rotational speed
334...338			Reserved
Active NC block			
342	ACT_BL	STRUCT	Active NC block
+ 0	PROG_NO	BYTE	Program number
+ 1	BLCK_NO	BYTE	Block number
+ 2.0	G_1_EN	BOOL	G function group 1

Table B-1 User data block (AW-DB), continued

Adresse absolut	Variable	Data type	Comment
+ 2.1	G_2_EN	BOOL	G function group 2
+ 2.2	G_3_EN	BOOL	G function group 3
+ 2.3			Reserved
+ 2.4	X_T_EN	BOOL	Position/dwell
+ 2.5	SR_L_EN	BOOL	No. of UP calls
+ 2.6	SR_N_EN	BOOL	UP call
+ 2.7	SKIP_EN	BOOL	Block skip
+ 3.0	V_EN	BOOL	Speed
+ 3.1	M_1_EN	BOOL	M function group 1
+ 3.2	M_2_EN	BOOL	M function group 2
+ 3.3	M_3_EN	BOOL	M function group 3
+ 3.4	TO_EN	BOOL	Tool offset
+ 3.5...+ 3.7			Reserved
+ 4	G_1_VAL	BYTE	G function no. of group 1
+ 5	G_2_VAL	BYTE	G function no. of group 2
+ 6	G_3_VAL	BYTE	G function no. of group 3
+ 7			Reserved
+ 8	X_T_VAL	DINT	Value for position/dwell
+ 12	V_VAL	DINT	Value for speed
+ 16	M_1_VAL	BYTE	M function no. of group 1
+ 17	M_2_VAL	BYTE	M function no. of group 2
+ 18	M_3_VAL	BYTE	M function no. of group 3
+ 19	TO_VAL	BYTE	Tool offset no.
		END_STRUCT	
Next NC block			
362	NXT_BL	STRUCT	Next NC block
+ 0	PROG_NO	BYTE	Program number
+ 1	BLCK_NO	BYTE	Block number
+ 2.0	G_1_EN	BOOL	G function group 1
+ 2.1	G_2_EN	BOOL	G function group 2
+ 2.2	G_3_EN	BOOL	G function group 3
+ 2.3			Reserved
+ 2.4	X_T_EN	BOOL	Position/dwell
+ 2.5	SR_L_EN	BOOL	No. of UP calls
+ 2.6	SR_N_EN	BOOL	UP call

Table B-1 User data block (AW-DB), continued

Adresse absolut	Variable	Data type	Comment
+ 2.7	SKIP_EN	BOOL	Block skip
+ 3.0	V_EN	BOOL	Speed
+ 3.1	M_1_EN	BOOL	M function group 1
+ 3.2	M_2_EN	BOOL	M function group 2
+ 3.3	M_3_EN	BOOL	M function group 3
+ 3.4	TO_EN	BOOL	Tool offset
+ 3.5...+ 3.7			Reserved
+ 4	G_1_VAL	BYTE	G function no. of group 1
+ 5	G_2_VAL	BYTE	G function no. of group 2
+ 6	G_3_VAL	BYTE	G function no. of group 3
+ 7			Reserved
+ 8	X_T_VAL	DINT	Value for position/dwel
+ 12	V_VAL	DINT	Value for speed
+ 16	M_1_VAL	BYTE	M function no. of group 1
+ 17	M_2_VAL	BYTE	M function no. of group 2
+ 18	M_3_VAL	BYTE	M function no. of group 3
+ 19	TO_VAL	BYTE	Tool offset no.
		END_STRUCT	
Application data			
382	APP1	DINT	Application data 1
386	APP2	DINT	Application data 2
390	APP3	DINT	Application data 3
394	APP4	DINT	Application data 4
Actual value block change			
398	BLCK_EXT	DINT	Actual value block change
Service data			
402	OUT_VAL	DINT	frequency output value
406	ENC_VAL	DINT	pulse output counter
410...414			Reserved
418	FOLL_ERR	DINT	Difference between setpoint and actual position
422			Reserved
426	OSC_ERR	DINT	Setpoint overshoot value/switch adjustment
430			Reserved
Additional operating data			
434	OVERRIDE1	BYTE	Override

Table B-1 User data block (AW-DB), continued

Adresse absolut	Variable	Data type	Comment
435	PROG_NO1	BYTE	NC traversing program no.
436	BLCK_NO1	BYTE	NC block no.
437	LOOP_NO1	BYTE	UP call counter
438	G90_91	BYTE	Active G90/91
439	G60_64	BYTE	Active G60/64
440	G43_44	BYTE	Active G43/44
441	TO_NO	BYTE	Active D number
442.0			Reserved
442.1	LIM_SP	BOOL	Speed limit
442.2... 442.7			Reserved
443.0	LIM_FR	BOOL	Start/stop frequency limited
443.1	LIM_FV	BOOL	Frequency value for acceleration limited
443.2			Reserved
443.3	LIM_FS	BOOL	Acceleration/deceleration value limited
443.4... 445			Reserved
Parameter/data			
446	PAR_RD	STRUCT	Parameter/data
+ 0	TYP	BYTE	DB type
+ 1	NUMB	BYTE	Number
+ 2	COUN	BYTE	Quantity
+ 3	JOB	BYTE	Request
+ 4	DATA1	ARRAY [450 ..469] BYTE	Array, structure/data type according to data, to be read as per bytes 1 to 4 of this structure
		END_STRUCT	
470		ARRAY [470...485] BYTE	Internal, Reserved
Measured values			
486	BEGIN_VAL	DINT	Initial value or on-the-fly measured value
490	END_VAL	DINT	Final value
494	LENGTH_VAL	DWORD	Measured length value
Operator control and monitoring			
498	USR	STRUCT	Operator control and monitoring

Table B-1 User data block (AW-DB), continued

Adresse absolut	Variable	Data type	Comment
+ 0.0	BITC_0	BOOL	Write MD
+ 0.1	BITC_1	BOOL	Read MD
+ 0.2	BITC_2	BOOL	MDI block transferred
+ 0.3	BITC_3	BOOL	Prog. sel. transferred
+ 0.4	BITC_4	BOOL	Teach-in transferred
+ 0.5	BITC_5	BOOL	Incremental dimension transferred
+ 0.6	BITC_6	BOOL	Speed levels transferred
+ 0.7	BITC_7	BOOL	Frequency levels transferred
+ 1.0	BITC_8	BOOL	MDI block transferred on-the-fly
+ 1.1	BITC_9	BOOL	Set actual value transferred
+ 1.2	BITC_10	BOOL	Zero offset transferred
+ 1.3...+ 1.4			Reserved
+ 1.5	BITC_13	BOOL	Diagnostic interrupt
+ 1.6	BITC_14	BOOL	Data error
+ 1.7	BITC_15	BOOL	Operator/traversing error
+ 2	MD_NO	WORD	MD number
+ 4	MD_VALUE	DINT	MD value
+ 8	INC_NO	BYTE	Incremental dimension number
+ 9			Reserved
+ 10	PICT_NO	WORD	Display number
+ 12	KEY_CODE	WORD	Keyboard code
+ 14...+15			Reserved
+ 16.0	BITA_0	BOOL	Open-loop control mode
+ 16.1	BITA_1	BOOL	Approach to reference point
+ 16.2	BITA_2	BOOL	Incremental mode (relative)
+ 16.3	BITA_3	BOOL	MDI
+ 16.4	BITA_4	BOOL	Auto/single block mode
+ 16.5	BITA_5	BOOL	Auto mode
+ 16.6	BITA_6	BOOL	Jog mode
+ 16.7... +17.5			Reserved
+ 17.6	BITA_14	BOOL	Acknowledge error
+ 17.7	BITA_15	BOOL	Acknowledge diagnostic interrupt
		END_STRUCT	



C

List of Abbreviations

AS	Automation system
BA	Mode
BA “A/AE”	“Automatic/Automatic single block” mode
BA “REF”	“Reference point approach” mode
BA “SM”	“Incremental approach” mode
BA “STE”	“Open-loop control” mode
BA “T”	“Jogging” mode
BP	Mode parameter
BR	Binary result
CPU	Central Processing Unit of the SIMATIC S7
DB	Data block
DBB	Data block byte
DBX	Data block bit
DB-MD	Data block for machine data
DB-NC	Data block for traversing programs
DB-SM	Data block for increments
DB-SS	Data block for status messages
DB-WK	Data block for tool offset data
DEKL	Detail event class
DENR	Detail event number
DP	Distributed I/O
EMC	Electromagnetic compatibility
EN	Enable (input parameter in LAD representation)
ENO	Enable Output (output parameter in LAD representation)
EPROM	Erasable programmable read-only memory
ESD	Electrostatic sensitive device
EXE	External pulse shaper
FB	Function block

FC	Function
FEPRM	Flash EPROM: Read/Write memory
FM	Function module
HEX	Hexadecimal
HMI	Device for operating and monitoring of a process
I	Input parameter
IM	Interface module (SIMATIC S7)
I/Q	Throughput parameter (initialization parameter)
LAD	Ladder program
LED	Light Emitting Diode
MDI	<u>M</u> anual <u>D</u> ata <u>I</u> nput
MLFB	Machine-readable order designation
MPI	Multi Point Interface
MSR	Measurement system raster
OB	Organization block
OP	Operator panel
PG	Programming device
PLC	Programmable controller
PS	Power Supply (SIMATIC S7)
PWM	Pulse width modulation
Q	Output parameter
RFG	Controller enable
RPS	Reference point switch
S7-300	PLC of medium performance range
SDB	System data block
SFC	System Function Call (integrated functions)
SM	Signal module (SIMATIC S7, e.g. input/output module)
SSI	Synchronous Serial Interface
STEP 7	Programming device software for SIMATIC S7
STL	Statement list
SZL	System status list
TF	Technology function
UP	User program



Index

A

- absolute dimensioning, 10-8
- acceleration, 9-69 , 9-73
- acceleration-override, 10-11
- active NC-block, 9-56
- actual value-block change, 9-57
- additional operating data, 9-58
- alarms, 7-10
- application, A-2
- application data, 9-57
 - request, 9-50
- Automatic, 9-10
 - block advance, 9-33
 - block return, 9-33
 - program selection, 9-31
- automatic, 9-31
 - backward processing, 9-32
 - forward processing, 9-32
- Automatic single block, 9-10
- automatic single block, 9-36
- axis type, 9-60
 - linear axis, 9-60
 - rotary axis, 9-61
 - rotary axis end, 9-61

B

- backlash compensation, 9-67
- basic operating data, 9-55
- block change, 10-4

C

- CE marking, ii
- CE-marking, A-2
- change parameters/data, 9-38
- changing direction, 9-71
- checkback signals, 8-23 , 9-2 , 9-6
- Communication between the CPU and the FM 353, 6-4
- configuration, 5-4
- configuring the interrupts, 5-5
- connected load, A-3
- Connecting an OP, 6-6

- connecting cables, 4-3
 - MPI- connecting cable, 4-3
 - setpoint cable, 4-3
- control loop, 7-21
- Control signals, 6-12 , 6-13 , 6-30 , 6-32
- control signals, 8-23 , 9-2 , 9-3
- COROS equipment (operator panels), 8-3
- Creating the AW-DB, 6-27
- CSA certification, A-1

D

- data blocks, 5-7
 - increments, 5-8 , 5-20
 - machine data, 5-7 , 5-9
 - status messages, 8-3
 - status messages , 8-20
 - system data block, 5-8
 - tool offset data, 5-8 , 5-21
 - traversing programs, 5-8 , 5-23
- data errors, 11-3
- data management, 9-41
- deactivate software end position monitoring, 9-43
- delete residual path, 9-45
- diagnostic buffer, 11-8
- Diagnostic data, 6-23
- Diagnostic information, 6-23
- diagnostic interrupts, 11-6 , 11-9
 - external channel errors, 11-6
 - external errors, 11-6
 - internal errors, 11-6
 - operating errors, 11-11
- diagnostics/errors (overview), 11-2
- Digital inputs, Messen, 9-52
- digital inputs, 4-14 , 9-77 , 9-78 , A-4
 - enable input, 9-78
 - external block change, 10-4
 - external start, 9-78
 - reference point switch for REF, 9-20
 - reversing switch for REF, 9-21
 - set actual value on-the-fly, 9-49
 - set actual value on-the-fly, 10-6
- digital outputs, 4-16 , 9-77 , 9-79 , A-4
 - direct output, 9-79

- dimensions, 10-8
- dimensions of the FM 353, A-3
- direction of machining, 9-32
- Distributed configuration, OB 86, 6-6
- drive enable, 9-4
- drive interface, 4-4
 - standard signals, 4-6 , 9-71
- drive unit, 4-11
- drive-interface, 9-71
 - optional signals, 4-6 , 4-9 , 4-14 , 9-71
 - standard signals, 4-6
- dwell, 10-4

E

- EMC guidelines, 4-1
- error class, 11-3
 - external channel errors, 11-3
 - external errors, 11-3
 - internal errors, 11-3
- error list, 11-9
 - data errors, 11-20
 - external channel errors, 11-11
 - external errors, 11-10
 - internal errors, 11-9
 - machine data errors, 11-25
 - operating errors, 11-11
 - operator control errors, 11-13
 - travel errors, 11-15
 - traversing program errors, 11-29
- error messages, 11-4
 - LED indicators, 11-4
- Error messages from the FM, 6-21 , 6-40
- error response, 11-4
- Evaluating a diagnostic interrupt, 6-45
- Evaluating a process interrupt, 6-44
- Executing mode control, 6-12 , 6-30
- external block change, 10-4

F

- FM approval, A-2
- FM cycle, 9-53 , 9-75 , 9-76 , 9-77 , 9-78 , A-3
- frequency generation, 9-69
 - working range of frequency generator, 5-19
- frequency levels, 9-18
- front connector, 1-7 , 4-12
 - connecting cables, 4-18
 - Wiring up the front connector, 4-18
- front connectors, 4-3
- front-panel elements, 1-7

G

- G functions, 10-3

I

- I/O interface, 4-12
- incremental dimensioning, 10-9
- Incremental relative, 9-10
- incremental relative, 9-24
- increments, 5-20
- inprocess measurement, 9-52
- installing the FM 353, 3-3
- interfaces, 1-7 , 4-4 , 4-12
 - drive interface, 4-4
 - drive-interface, 9-71
 - I/O interface, 4-12
- interpolator, 9-66
- Interrupt processing, 6-44
- Interrupts, 6-44
 - Evaluating a diagnostic interrupt, 6-45
 - Evaluating a process interrupt, 6-44
 - Interrupt processing, 6-44
 - Lost process interrupts, 6-44
- interrupts, 9-81 , 11-6

J

- Job request status, 6-15 , 6-33
- Jogging, 9-10 , 9-15

L

- length measurement, 9-53
- linear axis, 9-60
- Lost process interrupts, 6-44

M

- M functions, 10-14
- machine data, 5-9
 - activation, 7-13 , 9-45
 - dependencies, 5-16
 - input limits, 7-3
 - interdependencies, 7-3
- machine data list, 5-11
- MDI (Manual Data Input), 9-10 , 9-27
- measured values, 9-52
 - inprocess measurement, 9-52
 - length measurement, 9-53

measurement, 9-52
 mode parameter, 9-18
 mode parameter , 9-15 , 9-24
 module replacement, 5-8
 MPI connection, 1-4

N

next NC-block, 9-56

O

OP 07 menu tree, 8-5 , 8-10
 Open-loop control, 9-10
 open-loop control, 2-2 , 9-18
 Operating control mode, 6-18 , 6-37
 operating modes, 9-14
 automatic, 9-31
 automatic single block, 9-36
 incremental relative, 9-24
 Jogging, 9-15
 MDI, 9-27
 open-loop control, 9-18
 reference point approach, 9-19
 operator control and monitoring, 8-1 , 8-3
 data blocks, 8-1
 user data, 8-1
 operator/travel errors, 11-3
 optimization (machine axis), 7-21
 dynamic response, 7-21
 Optimized motion profile, 7-28
 Override, 9-4
 override
 acceleration-override, 10-11
 time-override, 9-5
 velocity-override, 9-4

P

parameterization, 5-1 , 5-25
 parameters/data, 9-58
 parking axis, 9-44
 ports
 drive -port, 1-8
 drive-port, 1-7
 I/O port, 1-7 , 1-8
 SIMATIC bus connector-port, 1-7 , 1-8
 POS_CTRL (FC 1) – data exchange, 6-12
 POS_DIAG (FC 2) – read diagnostic interrupt
 data, 6-22
 POS_INIT (FC 0) – Initialization, 6-10
 position resolution, 9-63

positioning, 2-1 , 7-20
 assessment criteria, 7-21
 open-loop control, 2-2
 status messages, 9-58
 process interrupts, 9-81
 processing in progress, 9-7
 Processing read and write requests, 6-12 ,
 6-14 , 6-30 , 6-32
 Processing Read requests, 6-18 , 6-37
 Processing Write requests, 6-17 , 6-36
 Program selection, block advance, 9-33
 program selection, 9-31
 block return, 9-33
 Programming the technological functions, 6-1
 Communication between the CPU and the
 FM 353, 6-4
 Fundamentals, 6-4
 Interface, user data blocks, 6-26 , 6-42
 Sample applications, 6-57
 Structure of a user program, 6-5
 Symbolic programming, 6-27 , 6-43
 Testing the user program, 6-6
 Writing the user program, 6-7
 Putting into operation, with the parameteriza-
 tion tool, 6-8

R

read data
 active NC-block, 9-56
 actual value-block change, 9-57
 additional operating data, 9-58
 application data, 9-57
 basic operating data, 9-55
 next NC-block, 9-56
 parameters/data, 9-58
 servicing data, 9-57
 read-in enable, 9-3
 reference point, 9-64
 Reference point approach, 9-10
 reference point approach, 9-19
 reducing velocity, 7-24
 referencing velocity, 7-24
 reference point coordinates, 7-24 , 7-26
 reference point offset, 9-64
 reference point switch, 9-20 , 9-64
 switch alignment, 9-57
 reference point switch , switch alignment, 7-24
 reference-point switch, 7-24
 removing the FM 353, 3-4
 Replacing modules, 3-5
 restart, 9-46
 retrigger reference point, 9-42

reversing switch, 9-21
rotary axis, 9-27 , 9-47 , 9-61
rotary axis end, 9-61
rotation monitoring, 9-43 , 9-75

S

safety rules, 4-1
 EMERGENCY- OF-F devices, 4-1
Sample applications, 6-57
service data, 7-10
servicing data, 9-57
servo enable, 9-43 , 9-71
Servo ready, 9-71
Set actual value, 9-19 , 9-46
set actual value, 9-48
 set actual value on-the-fly, 10-6
set actual value on-the-fly, 9-49
 set actual value on-the-fly, 9-49
Set actual value on-the-fly, 9-8
set actual value on-the-fly, 10-6
Set breakpoint, 6-6
set reference point, 9-51
SIMATIC Manager, 5-4
simulation, 9-44
Single commands, 6-20 , 6-21 , 6-40
 automatic block advance/return, 9-33
single commands
 activate machine data, 9-45
 delete residual path, 9-45
 restart, 9-46
 undo set actual value, 9-46
single functions, 9-42 , 9-44
 inprocess measurement, 9-42
 length measurement, 9-42
 parking axis, 9-44
 retrigger reference point, 9-42
 rotation monitoring, 9-43
 servo enable, 9-43
 simulation, 9-44
 software end position monitoring, 9-43
 switch off enable input, 9-43
Single settings, 6-20 , 6-21 , 6-39 , 6-40
slots for the FM 353, 3-2
software limit switches, 7-26 , 9-80

Standard function blocks, 6-9
 FC POS_CTRL (FC 1) – data interchange,
 6-12 , 6-30
 FC POS_DIAG (FC 2) – read diagnostic
 interrupt data, 6-22 , 6-41
 FC POS_INIT (FC 0) – Initialization, 6-10 ,
 6-30
 FC POS_MSRM (FC 3) – read measured
 values, 6-25 , 6-41
 Overview, 6-9
start enable, 9-6
Starting the axis, 7-18
startup, 7-7
Status signals, 6-12 , 6-13 , 6-30 , 6-32
step drive
 Boost, 9-72
 direction, 9-71
 pulse, 9-71
 PWM, 9-72
stepper drive, 9-66
stepper motor control, current-sourcing pattern,
 9-65
stepper motor control system, 9-66
 backlash compensation, 9-67
 current-sourcing pattern, 9-73
 current-sourcing pattern, 9-75
 drive interface, 9-71
 frequency generation, 9-69
 phase current control, 9-72
 rotation monitoring, 9-75
 stepper motor diagnostics, 9-72 , 9-75
 zero pulse external, 9-73 , 9-75
Structure of a user program, 6-5
 Signal processing, 6-5
switch off enable input, 9-43
Symbolic programming, 6-27 , 6-43
synchronization, 9-19 , 9-64
synchronizing the stepper motor axis, 9-64
 measured value-synchronization, 9-65
 reference point, 9-64
 reference point approach, 9-64
 reference point offset, 9-64
 reference point switch, 9-64
 synchronization point, 9-64

- system data, 9-37
 - change parameters/data, 9-38
 - measured values, 9-52
 - set actual value, 9-48
 - set actual value on-the-fly, 9-49
 - set reference point, 9-51
 - single functions, 9-42 , 9-44
 - zero offset, 9-46
 - system data block, 5-8 , 5-26
 - system of measurement, 9-59
- T**
- Teach in, 9-51
 - testing (machine axis), 7-7
 - The POS_CTRL (FC 1) block – data exchange, 6-30
 - The POS_DIAG (FC 2) block – read diagnostic interrupt data, 6-41
 - The POS_INIT (FC 0) block– Initialization, 6-30
 - The POS_MSRL (FC 3) block – read measured values, 6-25 , 6-41
 - time-override, 9-5
- tool compensation, 10-11
 - tool offset data, 5-21
 - Trace, 7-11
 - traversing block, 9-27
 - traversing blocks, 10-2
 - axis as rotary axis, 10-10
 - block change, 10-4
 - block structure, 10-2
 - G functions, 10-3
 - traversing programs, 5-23 , 9-31
 - direction of processing, 10-16
 - input, 5-24
 - program name, 10-1
 - program number, 10-1
 - program structure, 10-2
 - traversing block, 10-2
 - traversing blocks, 10-2
- U**
- UL certification, A-1
 - undo set actual value, 9-46
 - user data, 8-1
 - User data block, 6-46